

# 2635A

Hydra Series II Data Bucket

More Application, Information, and Pricing available at:



**TestWorld**

250 Technology Way  
Rocklin, CA 95765

sales@testworld.com  
1-855-200-TEST (8378)

Click to go [www.TestWorld.com](http://www.TestWorld.com)

**Users Manual**

PN 686698

November 1997

© 1997 Fluke Corporation, All rights reserved. Printed in U.S.A.

All product names are trademarks of their respective companies.

## LIMITED WARRANTY & LIMITATION OF LIABILITY

Each Fluke product is warranted to be free from defects in material and workmanship under normal use and service. The warranty period is one year and begins on the date of shipment. Parts, product repairs and services are warranted for 90 days. This warranty extends only to the original buyer or end-user customer of a Fluke authorized reseller, and does not apply to fuses, disposable batteries or to any product which, in Fluke's opinion, has been misused, altered, neglected or damaged by accident or abnormal conditions of operation or handling. Fluke warrants that software will operate substantially in accordance with its functional specifications for 90 days and that it has been properly recorded on non-defective media. Fluke does not warrant that software will be error free or operate without interruption.

Fluke authorized resellers shall extend this warranty on new and unused products to end-user customers only but have no authority to extend a greater or different warranty on behalf of Fluke. Warranty support is available if product is purchased through a Fluke authorized sales outlet or Buyer has paid the applicable international price. Fluke reserves the right to invoice Buyer for importation costs of repair/replacement parts when product purchased in one country is submitted for repair in another country.

Fluke's warranty obligation is limited, at Fluke's option, to refund of the purchase price, free of charge repair, or replacement of a defective product which is returned to a Fluke authorized service center within the warranty period.

To obtain warranty service, contact your nearest Fluke authorized service center or send the product, with a description of the difficulty, postage and insurance prepaid (FOB Destination), to the nearest Fluke authorized service center. Fluke assumes no risk for damage in transit. Following warranty repair, the product will be returned to Buyer, transportation prepaid (FOB Destination). If Fluke determines that the failure was caused by misuse, alteration, accident or abnormal condition of operation or handling, Fluke will provide an estimate of repair costs and obtain authorization before commencing the work. Following repair, the product will be returned to the Buyer transportation prepaid and the Buyer will be billed for the repair and return transportation charges (FOB Shipping Point).

THIS WARRANTY IS BUYER'S SOLE AND EXCLUSIVE REMEDY AND IS IN LIEU OF ALL OTHER WARRANTIES, EXPRESS OR IMPLIED, INCLUDING BUT NOT LIMITED TO ANY IMPLIED WARRANTY OF MERCHANTABILITY OR FITNESS FOR A PARTICULAR PURPOSE. FLUKE SHALL NOT BE LIABLE FOR ANY SPECIAL, INDIRECT, INCIDENTAL OR CONSEQUENTIAL DAMAGES OR LOSSES, INCLUDING LOSS OF DATA, WHETHER ARISING FROM BREACH OF WARRANTY OR BASED ON CONTRACT, TORT, RELIANCE OR ANY OTHER THEORY.

Since some countries or states do not allow limitation of the term of an implied warranty, or exclusion or limitation of incidental or consequential damages, the limitations and exclusions of this warranty may not apply to every buyer. If any provision of this Warranty is held invalid or unenforceable by a court of competent jurisdiction, such holding will not affect the validity or enforceability of any other provision.

Fluke Corporation  
P.O. Box 9090  
Everett, WA 98206-9090  
U.S.A.

Fluke Europe B.V.  
P.O. Box 1186  
5602 BD Eindhoven  
The Netherlands

# Table of Contents

Chapter	Title	Page
<b>1</b>	<b>Preparation for Use.....</b>	<b>1-1</b>
	Introduction .....	1-5
	Operating Modes .....	1-5
	Front Panel Operation .....	1-7
	Memory Card Operation .....	1-7
	Computer Operation.....	1-8
	Printer Operation.....	1-8
	Modem Operation .....	1-8
	Measurement Capabilities .....	1-9
	Mx+B Scaling .....	1-9
	Alarms .....	1-9
	Totalizer Channel.....	1-9
	Alarm Outputs and Digital I/O.....	1-9
	Applications Software .....	1-9
	Hydra Starter Package.....	1-10
	Hydra Logger .....	1-10
	Options and Accessories .....	1-10
	Memory Card Reader.....	1-10
	Connector Set, 2620A-100.....	1-10
	Setting Up the Instrument.....	1-11
	Unpacking and Inspecting the Instrument.....	1-11
	Adjusting the Handle .....	1-12
	Connecting the Instrument to a Power Source.....	1-12
	AC Operation.....	1-13
	DC Operation.....	1-13
	Input Channels .....	1-13
	Measurement Connections .....	1-14
	Using Shielded Wiring.....	1-14
	Crosstalk.....	1-14
	Universal Input Module Connections .....	1-14
	Alarm Outputs Connections.....	1-17
	DC Power.....	1-17
	Alarm Outputs .....	1-17
	External Trigger Input .....	1-17
	Digital I/O Connections .....	1-18

Digital I/O .....	1-18
Totalizer Input .....	1-18
Controls and Indicators .....	1-19
Front Panel Controls .....	1-19
Front Panel Indicators .....	1-19

**2 Front Panel Operations ..... 2-1**

Summary of Front Panel Operations .....	2-5
Configuring the Instrument for Operation.....	2-6
Turning the Power on.....	2-6
Selecting a Channel.....	2-8
Configuring a Measurement Channel.....	2-8
Configuring a Channel to Measure DC Volts .....	2-9
Configuring a Channel to Measure AC Volts .....	2-10
Configuring a Channel to Measure Resistance .....	2-11
Configuring a Channel to Measure Frequency .....	2-12
Configuring a Channel to Measure Temperature.....	2-13
Thermocouples .....	2-13
Resistance-Temperature Detectors .....	2-13
Thermocouple Restrictions:.....	2-13
Resistance Temperature Detectors Restrictions: .....	2-13
Configuring a Channel Off .....	2-16
Setting Operating Conditions .....	2-16
Setting the Scan Interval .....	2-17
Setting the Measurement Rate .....	2-18
Setting the Alarms.....	2-18
Alarm Indications While Scanning.....	2-18
Alarm Indications While Monitoring .....	2-19
Alarm Indications While Reviewing .....	2-19
Clearing Alarm Parameters from a Channel.....	2-19
Alarm Outputs for Channel 0 to 3 Using the Alarm Outputs Connector .	2-19
Alarm Outputs for Channels 4 to 20 Using the Digital I/O Connector ....	2-19
Alarms and Autoprinting .....	2-20
Alarms and Monitor-Alarm Triggering .....	2-20
Alarms and Mx+B Scaling .....	2-20
Setting the Mx+B Scaling.....	2-23
Examples.....	2-23
Restrictions .....	2-23
Clearing Mx+B Scaling from a Channel .....	2-23
Operating Modes .....	2-26
Using the Scan Mode .....	2-26
Memory Card as a Data Destination.....	2-26
Memory Card Formatting .....	2-26
Memory Card Capacity.....	2-26
Memory Card Files .....	2-26
Memory Card Exchange During Scanning.....	2-26
Memory Card Data Extraction.....	2-27
Memory Card Error Messages .....	2-28
Using the Monitor Mode.....	2-29
Using the Review Mode.....	2-30
Additional Features .....	2-31
Scan Triggering Options .....	2-31
External Trigger.....	2-31
Monitor-Alarm Trigger.....	2-31

	Triggering Options and Memory Card Operation .....	2-31
	Totalizer Operation .....	2-32
	Digital Input/output Lines .....	2-33
	Setting Date and Time.....	2-34
	Reading Instrument Software Versions .....	2-35
	Returning to the Local Mode .....	2-35
	Front Panel Key Lockout Options .....	2-36
	Instrument Interfaces .....	2-36
	Memory Card Interface .....	2-36
	RS-232 Computer Interface .....	2-37
	Using the RS-232 Computer Interface With a Printer .....	2-37
	Using the RS-232 Computer Interface With a Modem.....	2-37
<b>3</b>	<b>Memory Card Operations .....</b>	<b>3-1</b>
	Summary of Memory Card Operations .....	3-3
	Memory Card Files .....	3-3
	Setup Files.....	3-4
	Data Files .....	3-4
	Memory Card Capacity .....	3-4
	Memory Card Battery .....	3-5
	Inserting and Removing the Memory Card .....	3-5
	Inserting a Memory Card .....	3-5
	Removing a Memory Card.....	3-5
	Changing the Memory Card During Scanning.....	3-5
	Setting the Memory Card Write-protect Feature .....	3-5
	Installing or Replacing the Memory Card Battery .....	3-5
	Initializing a Memory Card .....	3-7
	Recording Measurement Results During Scanning.....	3-8
	Setup File Procedures.....	3-9
	Using Setup Store.....	3-9
	Using Setup Load.....	3-10
	Using Setup Erase .....	3-11
	Data File Procedures .....	3-12
	Using Data Open .....	3-12
	Using Data Erase.....	3-13
	Setup and Data Files Directory .....	3-14
	Setup and Data File Current Status .....	3-15
	Memory Card File Operations to and from a PC .....	3-16
<b>4</b>	<b>Computer Operations .....</b>	<b>4-1</b>
	Summary of Computer Operations.....	4-3
	Connecting the Instrument to a PC.....	4-3
	Configuring the Instrument for Computer Operations .....	4-5
	Configuring the PC for Computer Operations .....	4-6
	Testing the Instrument/PC RS-232 Interface .....	4-6
	Testing the RS-232 Interface Using Terminal Emulation (Windows) .....	4-6
	Testing the RS-232 Interface Using Terminal Emulation (Generic) .....	4-7
	Testing the RS-232 Interface Using Gwbasic .....	4-9
	Testing the RS-232 Interface Using Qbasic.....	4-10
	Computer Interface Commands and Operation.....	4-12
	How the Instrument Processes Input.....	4-12
	Input Terminators.....	4-12
	Input String Examples.....	4-13
	Sending Numeric Values to the Instrument .....	4-13

	How the Instrument Processes Output .....	4-13
	Status Registers .....	4-14
	Instrument Event Register (IER) .....	4-14
	Standard Event Status Register (ESR).....	4-16
	Status Byte Register (STB).....	4-17
	Computer Interface Command Set .....	4-18
	Xmodem File Transfers .....	4-18
<b>5</b>	<b>Printer Operations .....</b>	<b>5-1</b>
	Summary of Printer Operations .....	5-3
	Connecting the Instrument to a Printer.....	5-3
	Configuring for Printer Operations .....	5-5
	Printing Measurement Data and Memory Card Directory .....	5-6
	Problems?.....	5-6
	Printing Measurement Results During Scanning .....	5-6
	Printing the Review Array .....	5-8
	Printing the Directory of the Memory Card.....	5-9
<b>6</b>	<b>Modem Operations .....</b>	<b>6-1</b>
	Summary of Modem Operations .....	6-3
	Connecting the Modem to a PC for Modem Configuration.....	6-4
	Configuring the Instrument Modem for Modem Operations .....	6-4
	Connecting the Modem to an Instrument .....	6-6
	Configuring the Instrument for Modem Operations.....	6-7
	Testing the RS-232/Modem Interface .....	6-8
<b>7</b>	<b>Maintenance .....</b>	<b>7-1</b>
	Introduction .....	7-3
	Cleaning.....	7-3
	Line Fuse .....	7-3
	Selftest Diagnostics and Error Codes.....	7-4
	Performance Tests .....	7-4
	Accuracy Verification Test.....	7-7
	Channel Integrity Test.....	7-8
	Thermocouple Measurement Range Accuracy Test .....	7-9
	Four-Terminal Resistance Test .....	7-10
	Thermocouple Temperature Accuracy Test.....	7-10
	Open Thermocouple Response Test .....	7-11
	RTD Temperature Accuracy Test .....	7-13
	RTD Temperature Accuracy Test (Using Decade Resistance Source) ....	7-13
	RTD Temperature Accuracy Test (Using DIN/IEC 751 RTD).....	7-14
	Digital Input/Output Verification Tests.....	7-15
	Digital Output Test .....	7-15
	Digital Input Test.....	7-16
	Totalizer Test.....	7-17
	Totalizer Sensitivity Test.....	7-18
	Dedicated Alarm Output Test .....	7-18
	External Trigger Input Test.....	7-21
	Calibration .....	7-21
	Variations in the Display.....	7-22
	Service .....	7-22

**Appendices**

A	Specifications.....	A-1
B	Crosstalk Considerations .....	B-1
C	Binary Upload of Logged Data.....	C-1
D	RS-232 Cabling.....	D-1
E	8-Bit Binary-Coded-Decimal Table.....	E-1
F	Memory Card File Formats.....	F-1
G	True RMS Measurements .....	G-1

**Index**





# **List of Tables**

<b>Table</b>	<b>Title</b>	<b>Page</b>
1-1.	Data Bucket Features .....	1-6
1-2.	Options and Accessories .....	1-11
1-3.	Front Panel Keys Description .....	1-21
1-4.	Annunciator Descriptions .....	1-22
2-1.	Configuration Reset (Default) Settings .....	2-7
2-2.	Selftest Error Codes .....	2-7
2-3.	Thermocouple Ranges .....	2-14
2-4.	TTL Alarm Outputs (Channels 0 to 3) .....	2-20
2-5.	TTL Alarm Outputs (Channels 4 to 20) .....	2-21
3-1.	Memory Card Error Codes .....	3-6
4-1.	Instrument Event Register (IER) .....	4-16
4-2.	Event Status Register (ESR) .....	4-17
4-3.	Status Byte Register (STB) .....	4-18
4-4.	Command and Query Summary .....	4-19
4-5.	Command and Query Reference .....	4-23
7-1.	Power-Up Error Codes .....	7-4
7-2.	Recommended Test Equipment .....	7-6
7-3.	Performance Tests (Voltage, Resistance, and Frequency) .....	7-7
7-4.	Performance Tests for Thermocouple Temperature Function .....	7-11
7-5.	Performance tests for RTD Temperature Function (Resistance Source)(ITS-90)	7-14
7-6.	Performance Tests for RTD Temperature Function (DIN/ IEC 751 Amendment 2)(ITS-90) .....	7-15
7-7.	Digital Input Values .....	7-17
A-1.	DC Voltage Measurements - Resolution .....	A-2
A-2.	DC Voltage Measurements - Accuracy .....	A-2
A-3.	AC Voltage Measurements - Resolution .....	A-4
A-4.	AC Voltage Measurements - Accuracy .....	A-4
A-5.	Temperature Measurements - Accuracy (Thermocouples) (IPTS-68) .....	A-5
A-6.	Temperature Measurements - Accuracy (Thermocouples) (ITS-90) .....	A-6
A-7.	Temperature Measurements - Accuracy (RTDs) (IEC751 Amendment 2) (ITS-90) .....	A-7
A-8.	Temperature Measurements - Accuracy (RTDs) (IEC751 Amendment 1) (ITS-90) .....	A-7
A-9.	Temperature Measurements - Accuracy (RTDs) (IEC751) (IPTS-68) .....	A-8
A-10.	AC Voltage Measurements - Resolution .....	A-9

A-11. AC Voltage Measurements - Accuracy .....	A-9
A-12. AC Voltage Measurements .....	A-10
A-13. Resistance Measurements - Resolution. ....	A-11
A-14. Resistance Measurements - Accuracy (Four-Wire).....	A-11
A-15. Frequency Measurements-Resolution and Accuracy .....	A-12
A-16. Frequency Measurements - Input Sensitivity .....	A-12
A-17. Typical Scanning Rate .....	A-13
A-18. Autoranging Rates .....	A-14
C-1. Floating-Point Format.....	C-5
E-1. 8-Bit Binary-Coded-Decimal.....	E-2

# List of Figures

Figure	Title	Page
1-1.	Data Bucket Front and Rear Panels .....	1-7
1-2.	Typical Front Panel Display While Scanning .....	1-8
1-3.	Adjusting the Handle .....	1-12
1-4.	Connecting the Instrument to a Power Source.....	1-13
1-5.	Universal Input Module Connections .....	1-15
1-6.	Two-Terminal and Four-Terminal Connections .....	1-16
1-7.	ALARM OUTPUTS connector .....	1-17
1-8.	DIGITAL I/O Connector .....	1-18
1-9.	Front Panel Keys.....	1-19
1-10.	Primary Display .....	1-19
1-11.	Secondary Display .....	1-20
1-12.	Annunciator Display .....	1-20
2-1.	How to use the Control/Annunciator Diagrams .....	2-5
2-2.	Turning the Power On .....	2-6
2-3.	Selecting a Channel .....	2-8
2-4.	Configuring a Channel to Measure DC Volts.....	2-10
2-5.	Configuring a Channel to Measure AC Volts.....	2-11
2-6.	Configuring a Channel to Measure Resistance.....	2-11
2-7.	Configuring a Channel to Measure Frequency .....	2-12
2-8.	Configuring a Channel to Measure Temperature (Thermocouples).....	2-14
2-9.	Configuring a Channel to Measure Temperature (RTDs) .....	2-15
2-10.	Configuring a Channel Off .....	2-16
2-11.	Setting the Scan Interval .....	2-17
2-12.	Setting the Measurement Rate .....	2-18
2-13.	Setting the Alarms .....	2-22
2-14.	Setting the Mx+B Scaling.....	2-24
2-15.	Using the Scan Mode.....	2-27
2-16.	Memory Card Error Messages .....	2-28
2-17.	Using the Monitor Mode .....	2-29
2-18.	Using the Review Mode .....	2-30
2-19.	Scan Triggering Options.....	2-32
2-20.	Totalizer Operation.....	2-33
2-21.	Setting Date and Time .....	2-34
2-22.	Reading Instrument Software Versions .....	2-35
2-23.	Returning to LOCAL Mode.....	2-35

2-24.	Front Panel Key Lockout Options .....	2-36
3-1.	Typical Memory Card.....	3-3
3-2.	Front Panel Memory Card Percent Display.....	3-5
3-3.	Initializing a Memory Card.....	3-7
3-4.	Recording Measurement Results During Scanning.....	3-8
3-5.	Using SETUP STORE to Save Configuration Files.....	3-9
3-6.	Using SETUP LOAD to Load Configuration Files .....	3-10
3-7.	Using SETUP ERASE to Delete Configuration Files .....	3-11
3-8.	Using DATA OPEN to Save Measurement Data in a File .....	3-12
3-9.	Using DATA ERASE to Delete a Measurement Data File .....	3-13
3-10.	Using DIRECTORY to Examine SETUP and DATA files.....	3-14
3-11.	Using STATUS to Examine SETUP and DATA Files.....	3-15
4-1.	Connecting the Instrument to a PC.....	4-4
4-2.	Configuring the Instrument for Computer Operations .....	4-5
4-3.	Overview of Status and Event Data Registers .....	4-15
4-4.	Sample Program (GWBASIC).....	4-57
4-5.	Sample Program (QBASIC).....	4-59
4-6.	Sample Program (QuickC) (1 of 5).....	4-62
5-1.	Connecting the Instrument to a Printer.....	5-4
5-2.	Configuring the RS-232 Ports for Print Operations .....	5-5
5-3.	Printing Measurement Results During Scanning.....	5-7
5-4.	Printing the Review Array .....	5-8
5-5.	Printing the Memory Card Directory.....	5-10
6-1.	Overall PC-to-Instrument Modem Connection.....	6-3
6-2.	Connecting the Modem to a PC.....	6-5
6-3.	Connecting the Modem to an Instrument .....	6-6
6-4.	Configuring the Instrument RS-232 Port for Modem Operations .....	6-7
7-1.	Replacing the Line Fuse .....	7-3
7-2.	Four-Terminal Connections to 5700A.....	7-12
7-3.	Four-Terminal Connections to Decade Resistance Box .....	7-14
7-4.	Dedicated Alarms Output Test .....	7-20
7-5.	External Trigger Test.....	7-21
C-1.	ASCII String Decoding.....	C-3
C-2.	Floating_Point Conversion .....	C-6
C-3.	Example .....	C-8
D-1.	Summary of RS-232 Connections .....	D-3
D-2.	Hydra Series II (DB-9) to PC (DB-9) RS-232 Connection (Generic).....	D-4
D-3.	Hydra (DB-9) to PC (DB-25) RS-232 Connection.....	D-5
D-4.	Hydra Series II (DB-9) to Modem (DB-25) RS-232 Connection .....	D-6
D-5.	Hydra Series II (DB-9) to Printer (DB-25) RS-232 Connection .....	D-7
D-6.	RS-232 DB-9 and DB-25 Connectors.....	D-8
G-1.	Comparison of Common Waveforms .....	G-2

## CAUTION

**THIS IS AN IEC SAFETY CLASS 1 PRODUCT. BEFORE USING, THE GROUND WIRE IN THE LINE CORD OR THE REAR PANEL BINDING POST MUST BE CONNECTED FOR SAFETY.**

### Interference Information

This equipment generates and uses radio frequency energy and if not installed and used in strict accordance with the manufacturer's instructions, may cause interference to radio and television reception. It has been type tested and found to comply with the limits for a Class B computing device in accordance with the specifications of Part 15 of FCC Rules, which are designed to provide reasonable protection against such interference in a residential installation.

Operation is subject to the following two conditions:

- This device may not cause harmful interference.
- This device must accept any interference received, including interference that may cause undesired operation.

There is no guarantee that interference will not occur in a particular installation. If this equipment does cause interference to radio or television reception, which can be determined by turning the equipment off and on, the user is encouraged to try to correct the interference by one of more of the following measures:

- Reorient the receiving antenna
- Relocate the equipment with respect to the receiver
- Move the equipment away from the receiver
- Plug the equipment into a different outlet so that the computer and receiver are on different branch circuits

If necessary, the user should consult the dealer or an experienced radio/television technician for additional suggestions. The user may find the following booklet prepared by the Federal Communications Commission helpful: How to Identify and Resolve Radio-TV Interference Problems. This booklet is available from the U.S. Government Printing Office, Washington, D.C. 20402. Stock No. 004-000-00345-4.

### Declaration of the Manufacturer or Importer

We hereby certify that the Fluke Model 2635A Data Bucket is in compliance with BMPT Vfg 243/1991 and is RFI suppressed. The normal operation of some equipment (e.g. signal generators) may be subject to specific restrictions. Please observe the notices in the users manual. The marketing and sales of the equipment was reported to the Central Office for Telecommunication Permits (BZT). The right to retest this equipment to verify compliance with the regulation was given to the BZT.

### Bescheinigung des Herstellers/Importeurs

Hiermit wird bescheinigt, daß Fluke Model 2635A Data Bucket in Übereinstimmung mit den Bestimmungen der BMPT-AmtsblVfg 243/1991 funk-entstört ist. Der vorschriftsmäßige Betrieb mancher Geräte (z.B. Meßsender) kann allerdings gewissen Einschränkungen unterliegen. Beachten Sie deshalb die Hinweise in der Bedienungsanleitung. Dem Bundesamt für Zulassungen in der Telekommunikation wurde das Inverkehrbringen dieses Gerätes angezeigt und die Berechtigung zur Überprüfung der Seire auf Einhaltung der Bestimmungen eingeräumt.

Fluke Corporation

### ***Safety Terms in this Manual***

This instrument has been designed and tested in accordance with iec publication 1010, safety requirements for electrical measuring, control and laboratory equipment. This user manual contains information, warnings, and cautions that must be followed to ensure safe operation and to maintain the instrument in a safe condition. Use of this equipment in a manner not specified herein may impair the protection provided by the equipment.

The meter is designed for iec 664, installation category ii use. It is not designed for use in circuits rated over 4800va.

Warning statements identify conditions or practices that could result in personal injury or loss of life.

Caution statements identify conditions or practices that could result in damage to equipment.

### ***Symbols Marked on Equipment***



danger - high voltage.



ground (earth) terminal.



protective ground (earth) terminal. Must be connected to safety earth ground when the power cord is not used. See Chapter 2.



attention - refer to the manual. This symbol indicates that information about usage of a feature is contained in the manual. This symbol appears in the following two places on the instrument rear panel:

1. Ground binding post (left of line power connector). Refer to "Using External DC Power" in Chapter 2.
2. Alarm outputs/digital i/o connectors. Refer to Appendix A, Specifications.

### **Warning**

#### **To avoid electric shock:**

- **When the input module is installed, consider all channels with connections as accessible terminals that may be hazardous live.**
- **Disconnect the input module before touching or changing external wiring.**
- **Remove inputs from live voltages before opening the input module.**

**AC Power Source**

The instrument is intended to operate from an ac power source that will not apply more than 264v ac rms between the supply conductors or between either supply conductor and ground. A protective ground connection by way of the grounding conductor in the power cord is required for safe operation.

**DC Power Source**

The instrument may also be operated from a 9 to 16v dc power source when either the rear panel ground binding post or the power cord grounding conductor is properly connected.

**Use the Proper Fuse**

To avoid fire hazard, use only a fuse identical in type, voltage rating, and current rating as specified on the rear panel fuse rating label.

**Grounding the Instrument**

The instrument utilizes controlled overvoltage techniques that require the instrument to be grounded whenever normal mode or common mode ac voltages or transient voltages may occur. The enclosure must be grounded through the grounding conductor of the power cord, or if operated on battery with the power cord unplugged, through the rear panel ground binding post.

**Use the Proper Power Cord**

Use only the power cord and connector appropriate for the voltage and plug configuration in your country.

Use only a power cord that is in good condition.

Refer cord and connector changes to qualified service personnel.

**Do Not Operate in Explosive Atmospheres**

To avoid explosion, do not operate the instrument in an atmosphere of explosive gas.

**Do Not Remove Cover**

To avoid personal injury or death, do not remove the instrument cover. Do not operate the instrument without the cover properly installed. Normal calibration is accomplished with the cover closed, and there are no user-serviceable parts inside the instrument, so there is no need for the operator to ever remove the cover. Access procedures and the warnings for such procedures are contained in the service manual. Service procedures are for qualified service personnel only.

**Do Not Attempt to Operate if Protection may be Impaired**

If the instrument appears damaged or operates abnormally, protection may be impaired. Do not attempt to operate it. When in doubt, have the instrument serviced.

# Ten Minute Tour

## Introduction

### *Note*

*This manual contains information and warnings that must be followed to ensure safe operation and keep the instrument in safe condition.*

Data Bucket operation and operational features can be understood in about ten minutes by completing the following procedure. Prior to starting the procedure, connect the instrument to a power source (see Chapter 1) and connect the supplied test leads to the front panel jacks (Channel 0). Some steps terminate when you press the **CANCEL** key instead of the **ENTER** key because the completed step is beyond the scope of this quick tour. However, all steps contain a figure reference in brackets [ ] for additional information. For example, the first step of applying power refers to [Figure 2-2], which describes three other ways of applying power (Configuration-Reset, Display-Hold, and Temperature-Toggle). Therefore, this procedure may be used for a quick instrument familiarization or as a basis for instrument applications.

It is assumed that the instrument is being powered for the first time or a configuration-reset procedure cleared the instrument of configuration data. To apply a configuration-reset to the instrument, hold down the **CANCEL** key when turning on the power and keep holding until the meter “beeps” in acknowledgment.



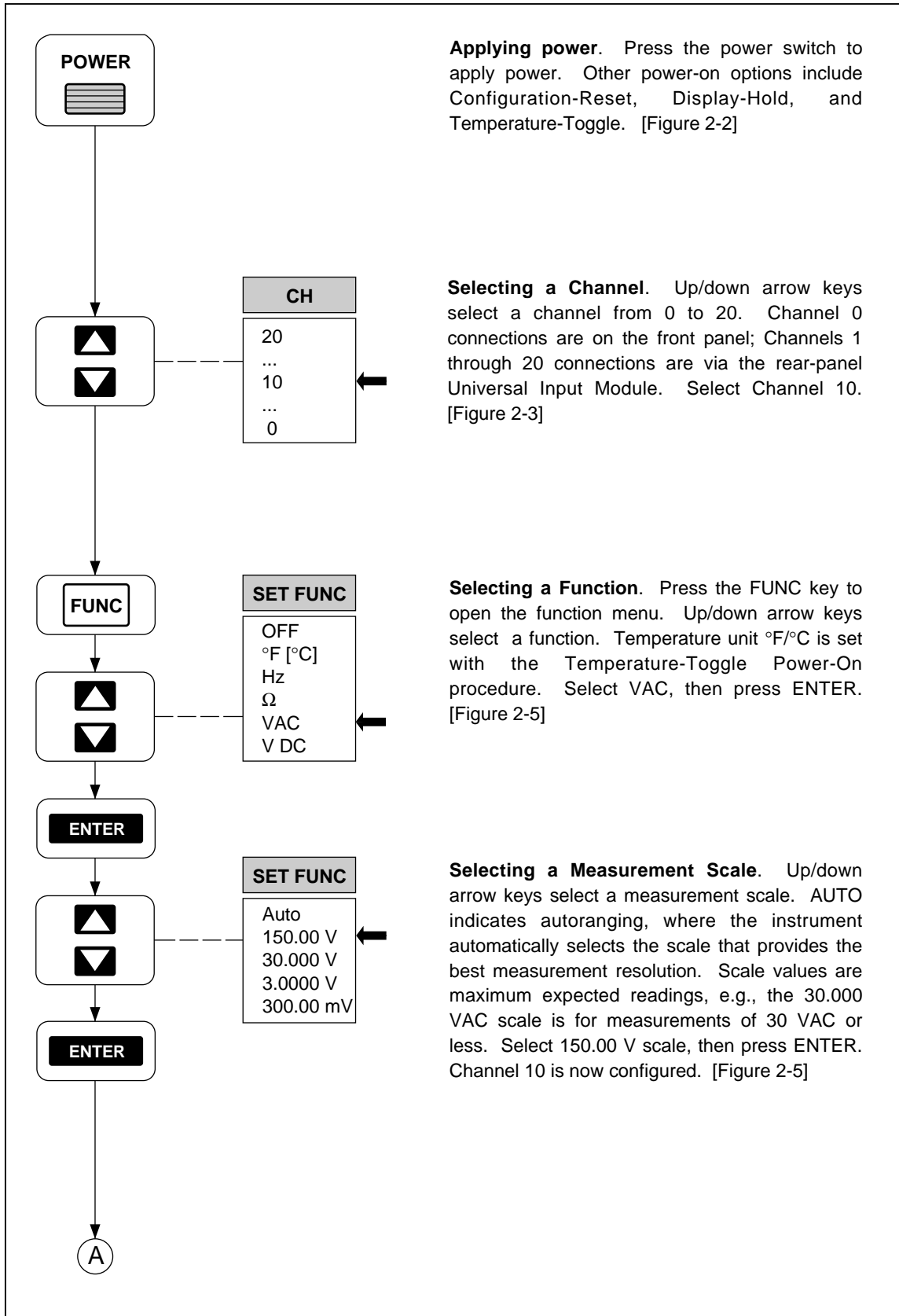

**Applying power.** Press the power switch to apply power. Other power-on options include Configuration-Reset, Display-Hold, and Temperature-Toggle. [Figure 2-2]

**Selecting a Channel.** Up/down arrow keys select a channel from 0 to 20. Channel 0 connections are on the front panel; Channels 1 through 20 connections are via the rear-panel Universal Input Module. Select Channel 10. [Figure 2-3]

**Selecting a Function.** Press the FUNC key to open the function menu. Up/down arrow keys select a function. Temperature unit °F/°C is set with the Temperature-Toggle Power-On procedure. Select VAC, then press ENTER. [Figure 2-5]

**Selecting a Measurement Scale.** Up/down arrow keys select a measurement scale. AUTO indicates autoranging, where the instrument automatically selects the scale that provides the best measurement resolution. Scale values are maximum expected readings, e.g., the 30.000 VAC scale is for measurements of 30 VAC or less. Select 150.00 V scale, then press ENTER. Channel 10 is now configured. [Figure 2-5]

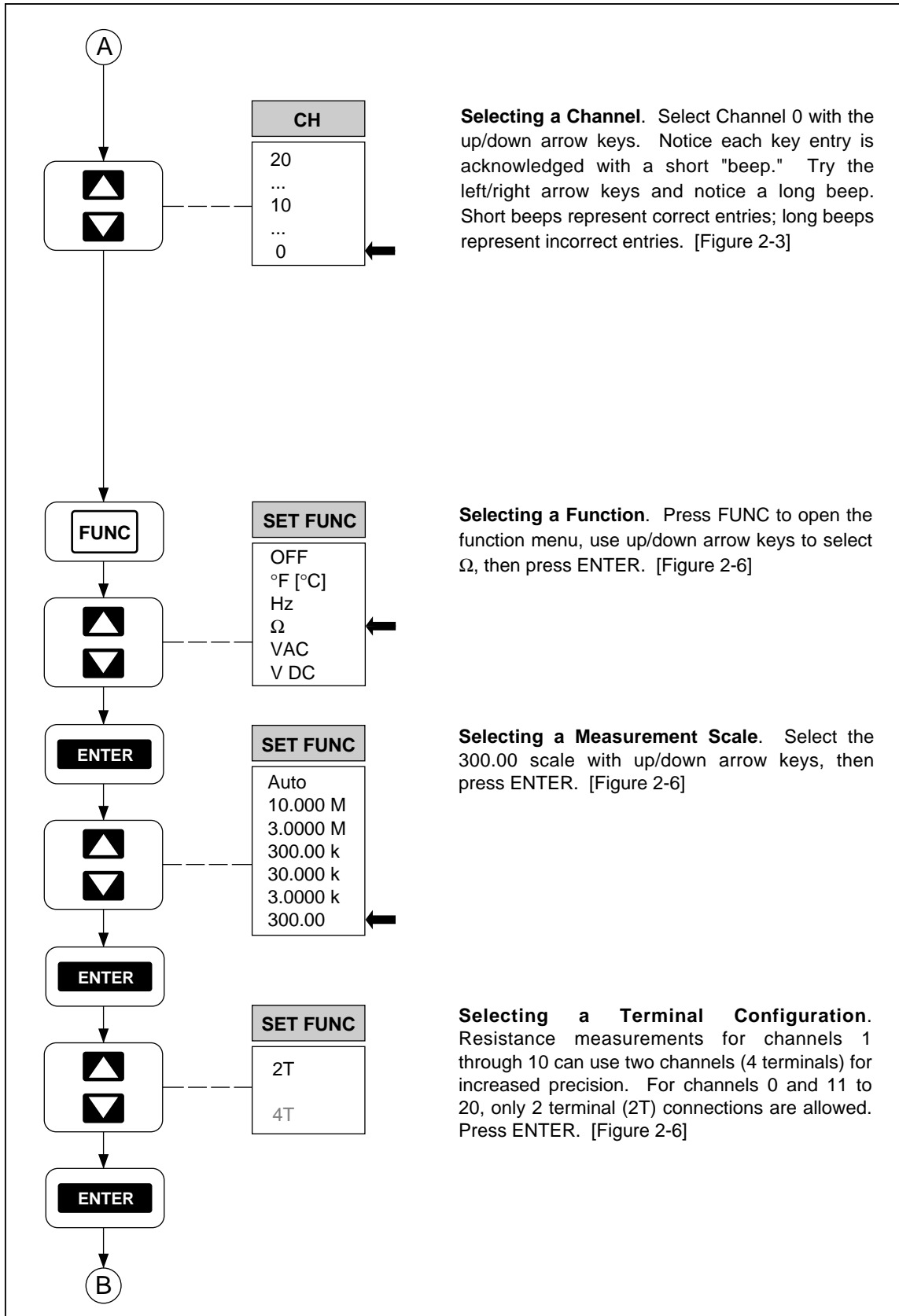

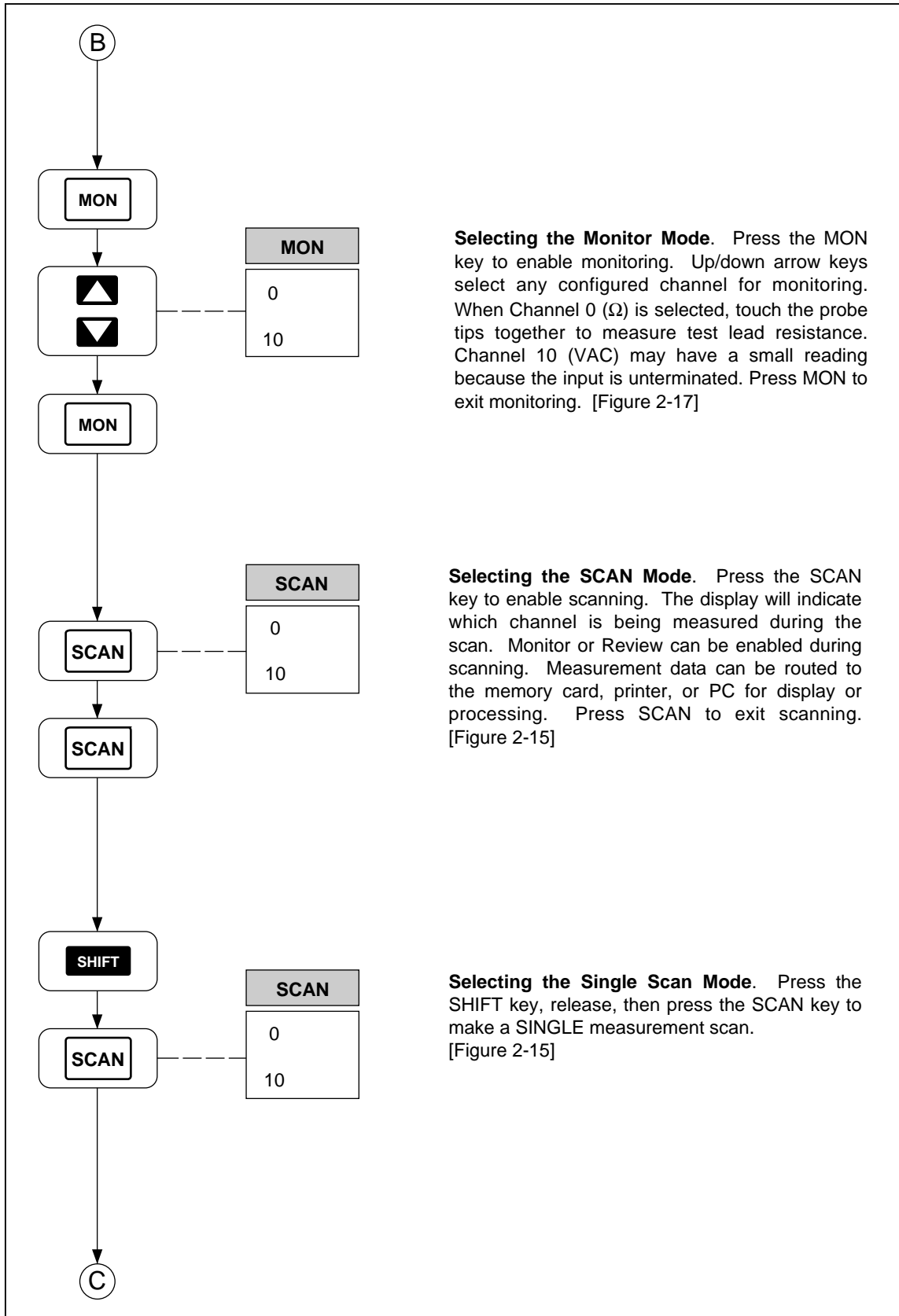

**Selecting the Monitor Mode.** Press the MON key to enable monitoring. Up/down arrow keys select any configured channel for monitoring. When Channel 0 ( $\Omega$ ) is selected, touch the probe tips together to measure test lead resistance. Channel 10 (VAC) may have a small reading because the input is unterminated. Press MON to exit monitoring. [Figure 2-17]

**Selecting the SCAN Mode.** Press the SCAN key to enable scanning. The display will indicate which channel is being measured during the scan. Monitor or Review can be enabled during scanning. Measurement data can be routed to the memory card, printer, or PC for display or processing. Press SCAN to exit scanning. [Figure 2-15]

**Selecting the Single Scan Mode.** Press the SHIFT key, release, then press the SCAN key to make a SINGLE measurement scan. [Figure 2-15]

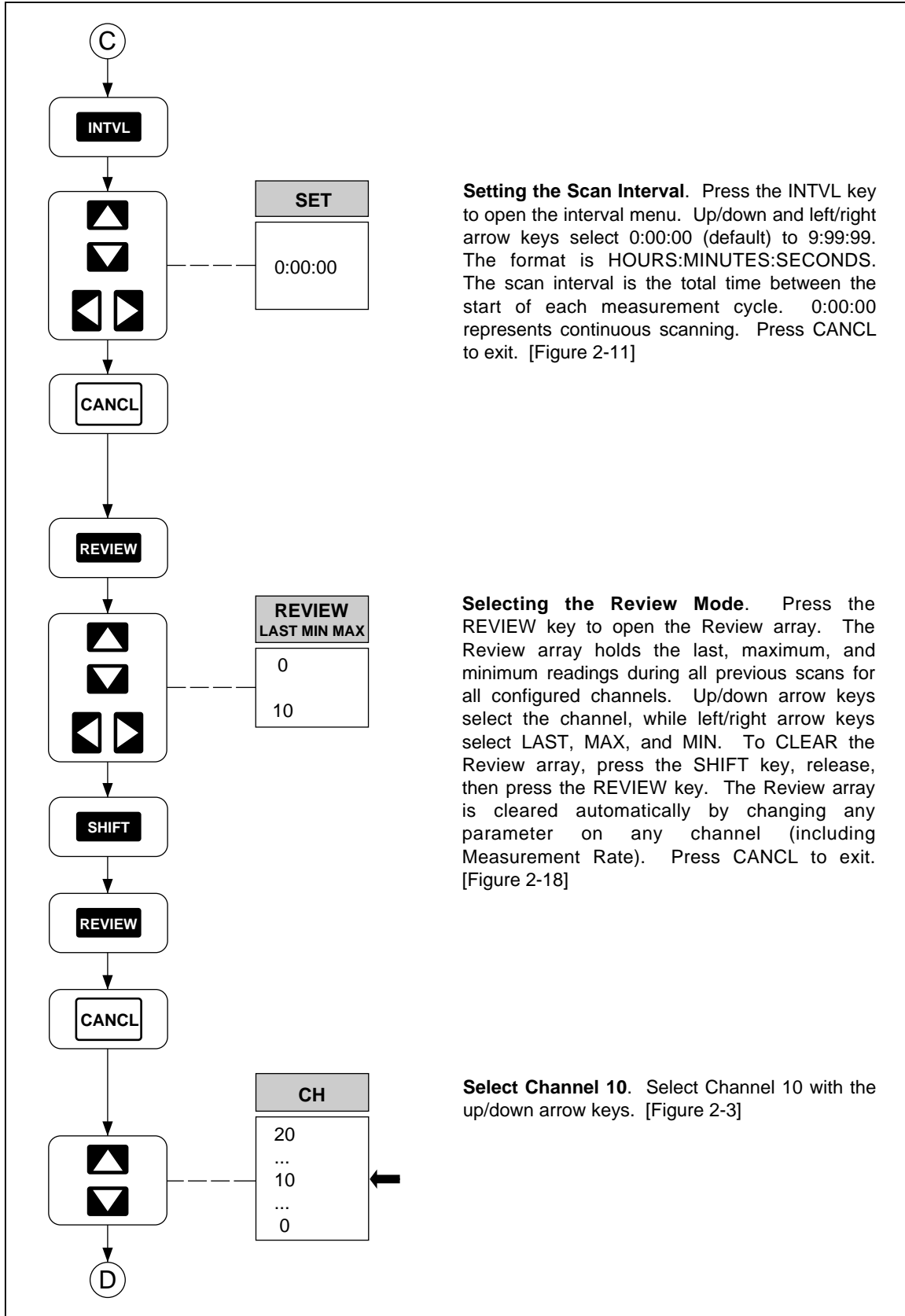

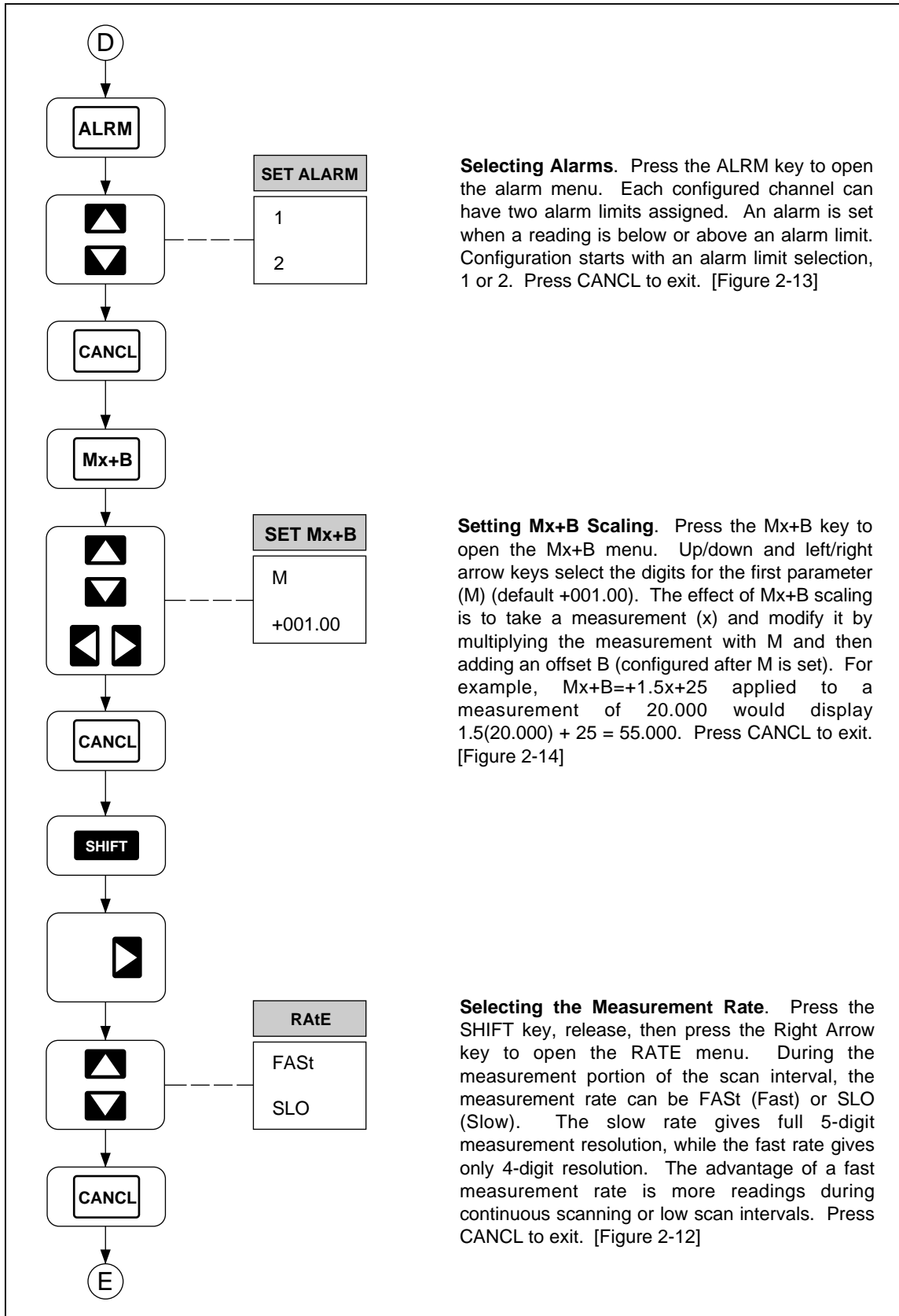

**Selecting Alarms.** Press the ALRM key to open the alarm menu. Each configured channel can have two alarm limits assigned. An alarm is set when a reading is below or above an alarm limit. Configuration starts with an alarm limit selection, 1 or 2. Press CANCL to exit. [Figure 2-13]

**Setting Mx+B Scaling.** Press the Mx+B key to open the Mx+B menu. Up/down and left/right arrow keys select the digits for the first parameter (M) (default +001.00). The effect of Mx+B scaling is to take a measurement (x) and modify it by multiplying the measurement with M and then adding an offset B (configured after M is set). For example,  $Mx+B=+1.5x+25$  applied to a measurement of 20.000 would display  $1.5(20.000) + 25 = 55.000$ . Press CANCL to exit. [Figure 2-14]

**Selecting the Measurement Rate.** Press the SHIFT key, release, then press the Right Arrow key to open the RATE menu. During the measurement portion of the scan interval, the measurement rate can be FASt (Fast) or SLO (Slow). The slow rate gives full 5-digit measurement resolution, while the fast rate gives only 4-digit resolution. The advantage of a fast measurement rate is more readings during continuous scanning or low scan intervals. Press CANCL to exit. [Figure 2-12]

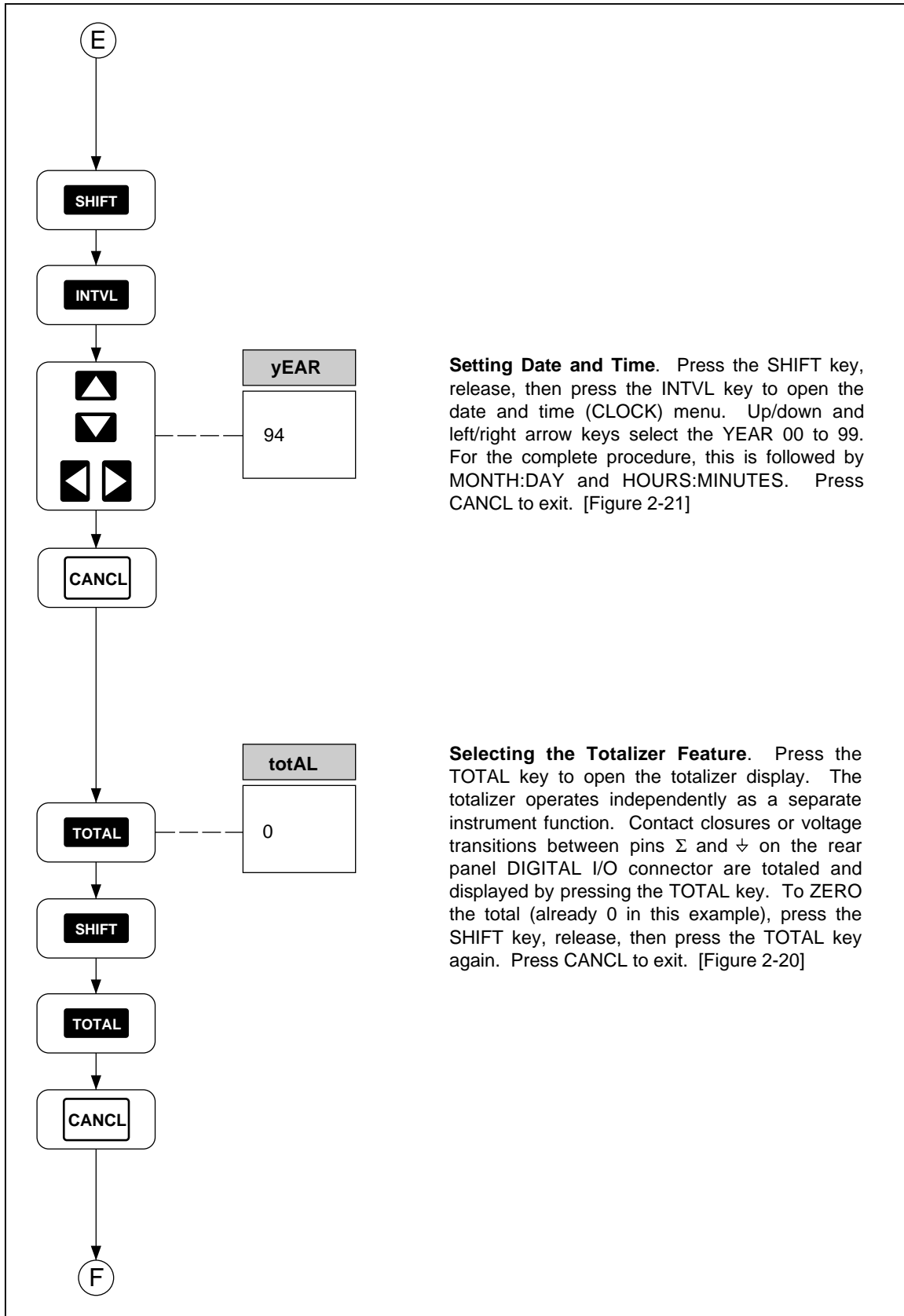

**Setting Date and Time.** Press the SHIFT key, release, then press the INTVL key to open the date and time (CLOCK) menu. Up/down and left/right arrow keys select the YEAR 00 to 99. For the complete procedure, this is followed by MONTH:DAY and HOURS:MINUTES. Press CANCL to exit. [Figure 2-21]

**Selecting the Totalizer Feature.** Press the TOTAL key to open the totalizer display. The totalizer operates independently as a separate instrument function. Contact closures or voltage transitions between pins  $\Sigma$  and  $\downarrow$  on the rear panel DIGITAL I/O connector are totaled and displayed by pressing the TOTAL key. To ZERO the total (already 0 in this example), press the SHIFT key, release, then press the TOTAL key again. Press CANCL to exit. [Figure 2-20]

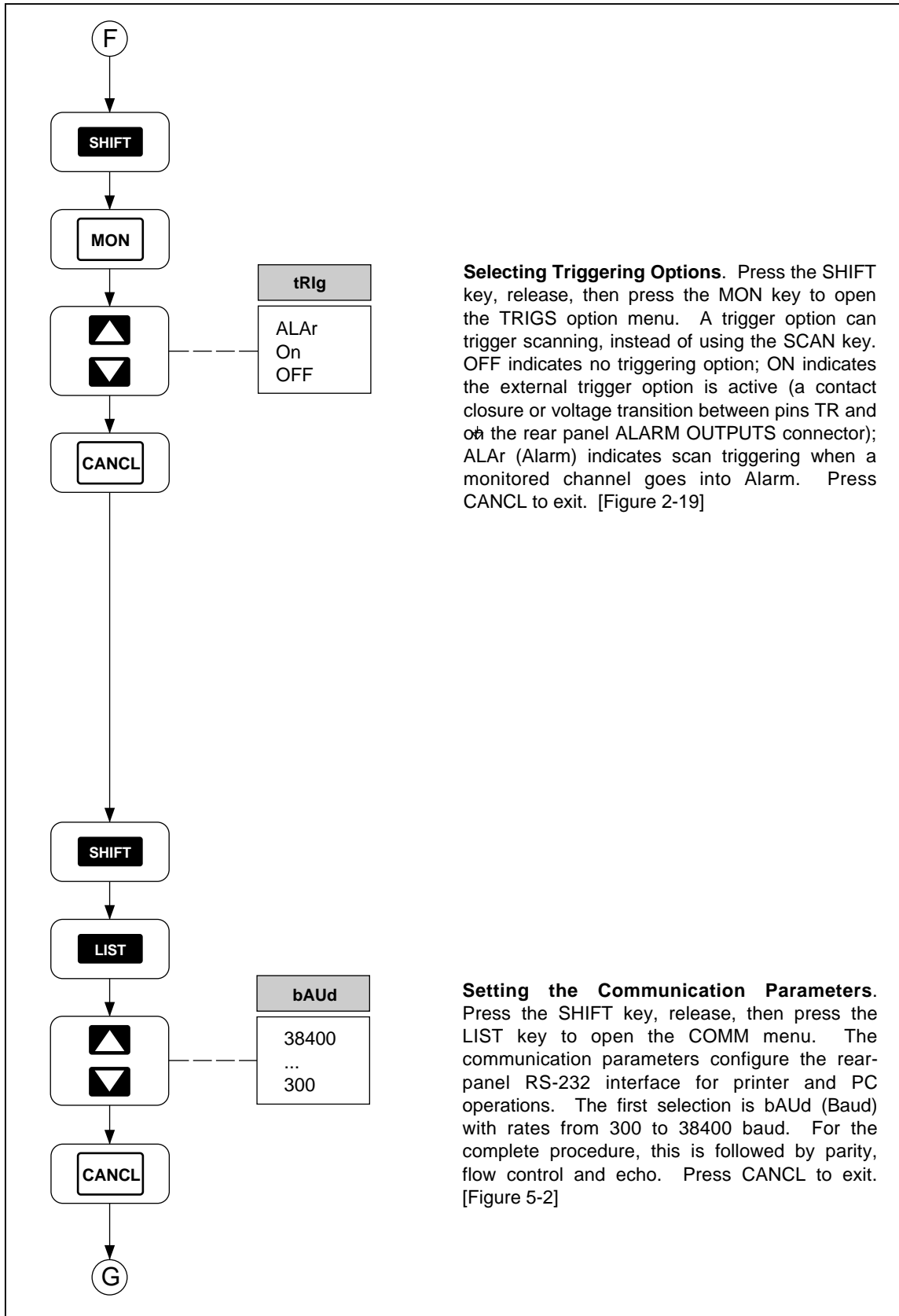

**Selecting Triggering Options.** Press the SHIFT key, release, then press the MON key to open the TRIGS option menu. A trigger option can trigger scanning, instead of using the SCAN key. OFF indicates no triggering option; ON indicates the external trigger option is active (a contact closure or voltage transition between pins TR and  $\phi$  on the rear panel ALARM OUTPUTS connector); ALAr (Alarm) indicates scan triggering when a monitored channel goes into Alarm. Press CANCL to exit. [Figure 2-19]

**Setting the Communication Parameters.** Press the SHIFT key, release, then press the LIST key to open the COMM menu. The communication parameters configure the rear-panel RS-232 interface for printer and PC operations. The first selection is bAUd (Baud) with rates from 300 to 38400 baud. For the complete procedure, this is followed by parity, flow control and echo. Press CANCL to exit. [Figure 5-2]

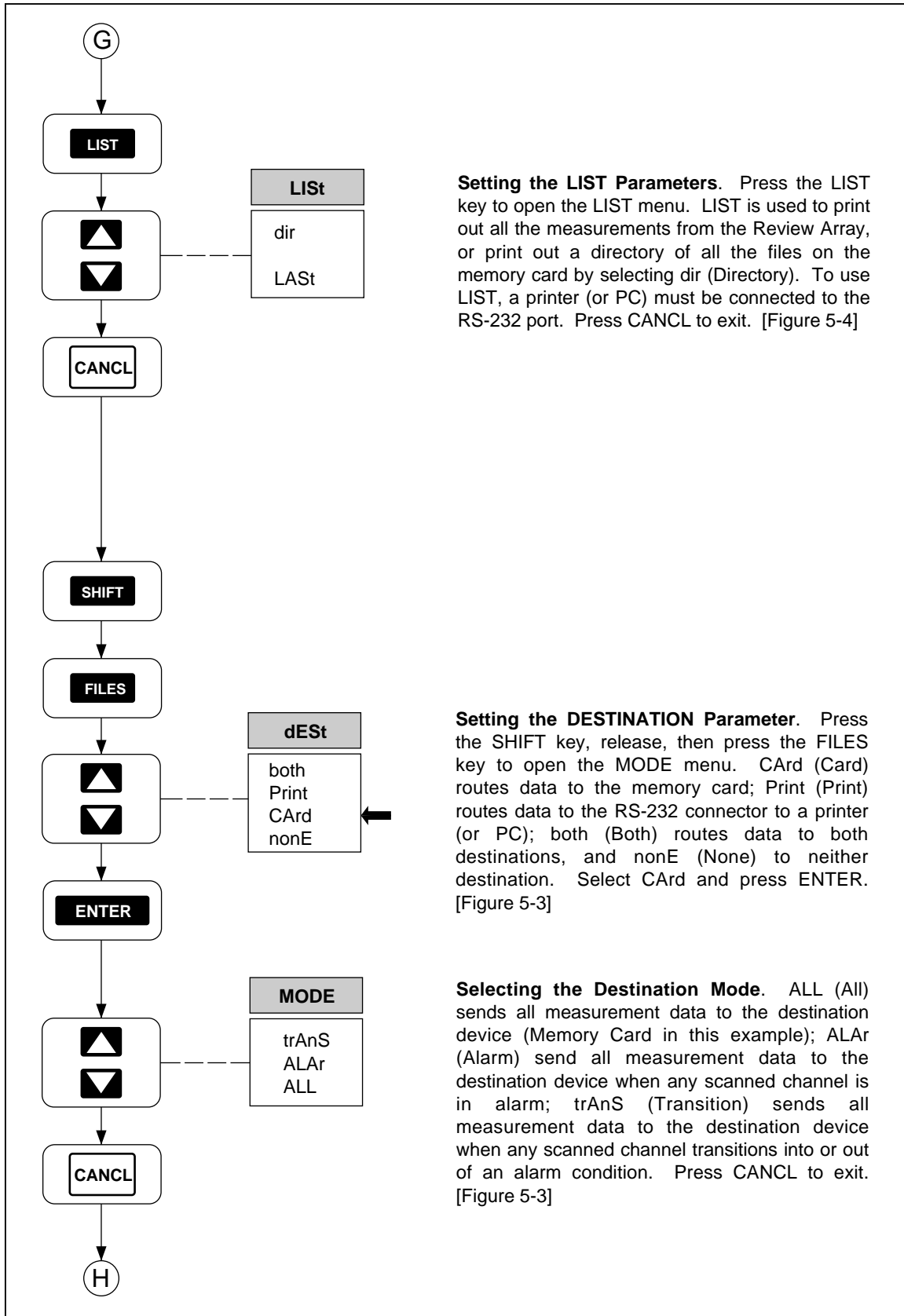

**Setting the LIST Parameters.** Press the LIST key to open the LIST menu. LIST is used to print out all the measurements from the Review Array, or print out a directory of all the files on the memory card by selecting dir (Directory). To use LIST, a printer (or PC) must be connected to the RS-232 port. Press CANCL to exit. [Figure 5-4]

**Setting the DESTINATION Parameter.** Press the SHIFT key, release, then press the FILES key to open the MODE menu. CARD (Card) routes data to the memory card; Print (Print) routes data to the RS-232 connector to a printer (or PC); both (Both) routes data to both destinations, and nonE (None) to neither destination. Select CArd and press ENTER. [Figure 5-3]

**Selecting the Destination Mode.** ALL (All) sends all measurement data to the destination device (Memory Card in this example); ALAr (Alarm) send all measurement data to the destination device when any scanned channel is in alarm; trAnS (Transition) sends all measurement data to the destination device when any scanned channel transitions into or out of an alarm condition. Press CANCL to exit. [Figure 5-3]



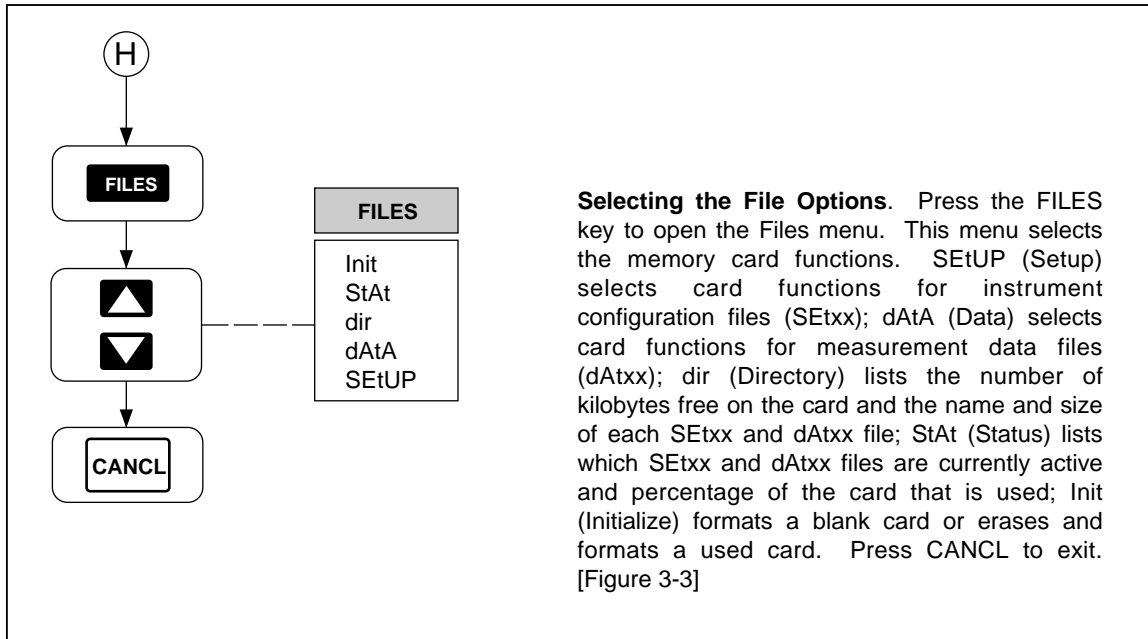

op79\_9f.eps



# Chapter 1

## *Preparation for Use*

Title	Page
Introduction .....	1-5
Operating Modes .....	1-5
Front Panel Operation .....	1-7
Memory Card Operation .....	1-7
Computer Operation.....	1-8
Printer Operation.....	1-8
Modem Operation .....	1-8
Measurement Capabilities .....	1-9
Mx+B Scaling .....	1-9
Alarms .....	1-9
Totalizer Channel.....	1-9
Alarm Outputs and Digital I/O.....	1-9
Applications Software .....	1-9
Hydra Starter Package.....	1-10
Hydra Logger .....	1-10
Options and Accessories .....	1-10
Memory Card Reader.....	1-10
Connector Set, 2620A-100.....	1-10
Setting Up the Instrument.....	1-11
Unpacking and Inspecting the Instrument.....	1-11
Adjusting the Handle .....	1-12
Connecting the Instrument to a Power Source.....	1-12
AC Operation.....	1-13
DC Operation.....	1-13
Input Channels .....	1-13
Measurement Connections .....	1-14
Using Shielded Wiring.....	1-14
Crosstalk.....	1-14
Universal Input Module Connections .....	1-14
Alarm Outputs Connections.....	1-17
DC Power.....	1-17
Alarm Outputs .....	1-17
External Trigger Input .....	1-17
Digital I/O Connections .....	1-18
Digital I/O.....	1-18

Totalizer Input .....	1-18
Controls and Indicators .....	1-19
Front Panel Controls .....	1-19
Front Panel Indicators .....	1-19



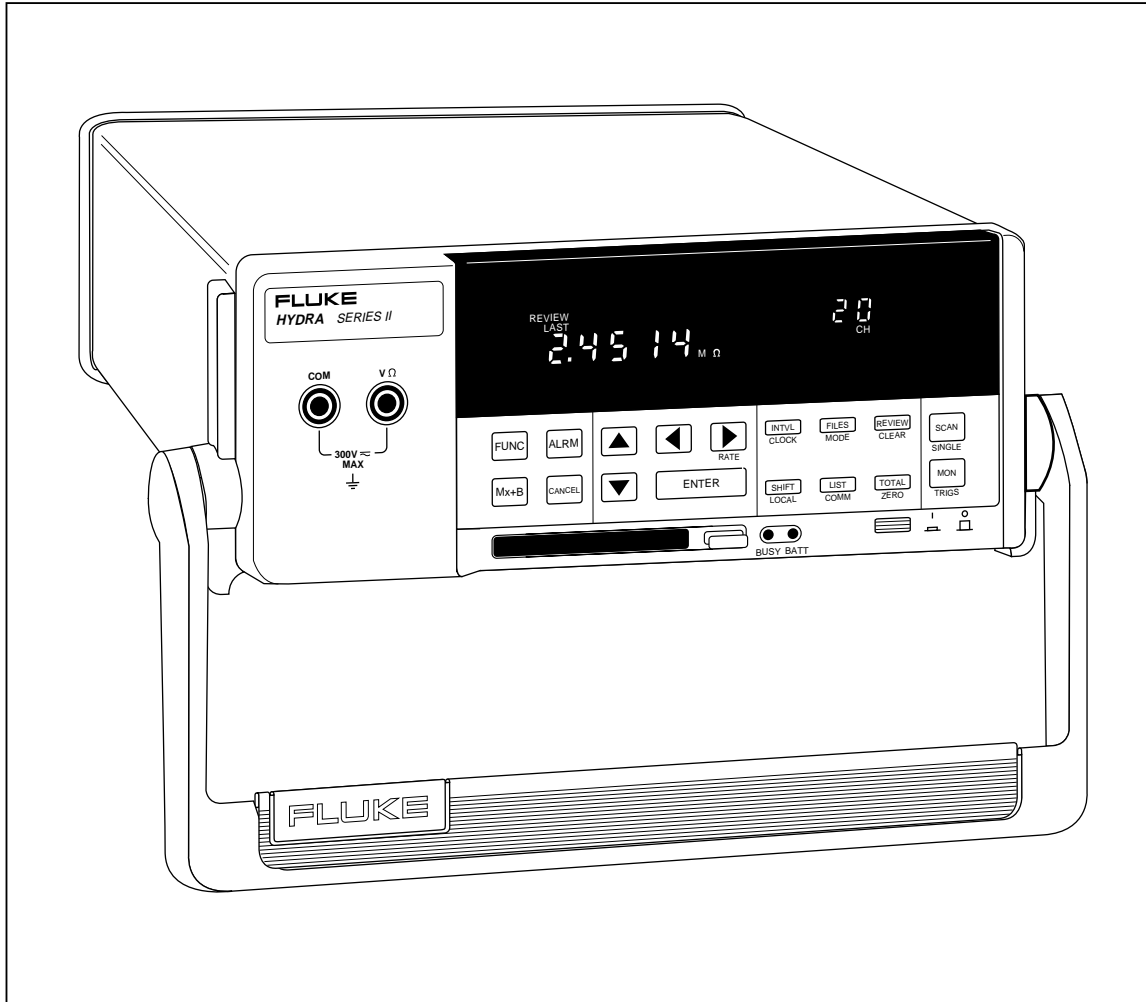

OP80F.EPS

**NOTE**

*This manual contains information and warnings that must be followed to ensure safe operation and keep the instrument in safe condition.*

**Introduction**

The Fluke 2635A Hydra Series II Data Bucket is a 21-channel data logging instrument that measures and records the following electrical and physical parameters: dc volts, ac volts, resistance, frequency, and temperature. Temperature measurements are via thermocouples or resistance-temperature detectors (RTDs). Other parameters can be measured with an appropriate transducer, such as air pressure/vacuum (using a Fluke PV350 transducer module) or DC current (using a Fluke 2600A-101 shunt resistor). When the instrument scans channels configured for measurement, readings can be displayed, printed out, and recorded. Virtually any analog input may be applied without external signal conditioning. The inputs for channels 1 through 20 are via a Universal Input Module, which plugs into the rear of the unit for a quick connect/disconnect capability. Channel 0 measurements are via the front panel input jacks using test leads (supplied). For a quick introduction to the operation of the instrument, complete the Ten-Minute Tour at the front of this manual. A summary of the Hydra Series II Data Bucket features is provided in Table 1-1 and complete specifications in Appendix A. Figure 1-1 shows the instrument front and rear panels.

**Operating Modes**

The Data Bucket may be used in a wide variety of applications using one or more of five operating modes:

- Front Panel Operation
- Memory Card Operation
- Computer Operation
- Printer Operation
- Modem Operation

**Table 1-1. Data Bucket Features**

<ul style="list-style-type: none"><li>• Channel Scanning Can be continuous scanning, scanning at an interval time, single scans, or triggered (internal or external) scans. Channel Monitoring may be used while scanning.</li><li>• Channel Monitoring Make measurements on a single channel and view these measurements on the display.</li><li>• Memory Card Store measurement data and meter configuration setup data on a removable nonvolatile RAM card.</li><li>• Multi-Function Display Primary display shows measurement readings; also used when setting numeric parameters. Secondary display used for numeric entries, channel number selection and display, status information, and operator prompts. Annunciator display used to show measurement units, alarms review parameters, remote status, and configuration information.</li><li>• Front-Panel Operation Almost all operations can be readily controlled with the front panel keys.</li><li>• Measurement Input Function and Range Volts dc (VDC), volts ac (VAC), frequency (HZ), and resistance (<math>\Omega</math>) inputs can be specified in a fixed measurement range. Autoranging, which allows the instruments to use the measurement range providing the optimum resolution, can also be selected.</li><li>• Temperature Measurement Thermocouple types J, K, E, T, N, R, S and B, and Hoskins Engineering Co. type C are supported. Also, DIN/IEC 751 Platinum RTDs are supported.</li><li>• Totalize Events on the Totalizing Input</li><li>• Alarm Limits and Digital Output Alarm Indication</li><li>• Four-Terminal Resistance Measurements (Channels 1 through 10 only)</li><li>• RS-232 Computer Interface Operation</li><li>• Measurement Rate Selection</li><li>• Nonvolatile Memory Storage of minimum, maximum, and most recent measurements for all scanned channels. Storage of Computer Interface setup, channel configurations, and calibration values. Internal storage of measurement data: storage for 100 scans of up to 21 channels, accessible only through the computer interface.</li></ul>
--



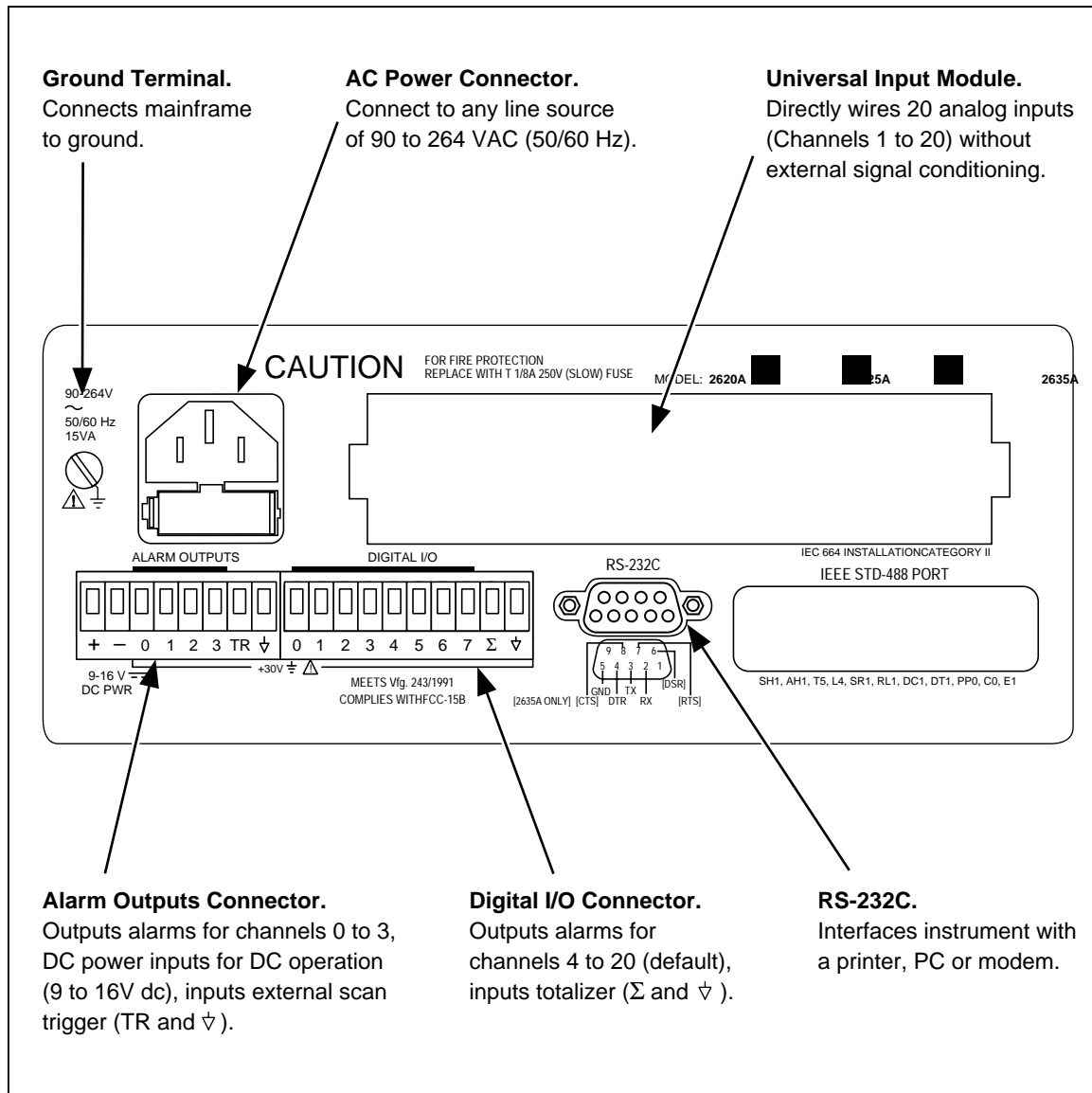

Figure 1-1. Data Bucket Front and Rear Panels

op01f.eps

### Front Panel Operation

Front panel operations include configuration of channels in preparation for scanning operations and simple multimeter operation by placing the instrument in the Monitor mode then using the front panel jacks and test leads (channel 0) for measurements. Front panel operations are discussed in Chapter 2.

### Memory Card Operation

An adjunct to stand-alone front panel use are operations that use the memory card feature. The memory card is a Static Random Access Memory (SRAM) device that plugs into a slot on the Data Bucket front panel. An internal battery maintains the integrity of the stored data. An empty 256K-byte card stores 8500 scans of 4 channels, 4500 scans of 10 channels, or 2500 scans of 20 channels. A typical display while scanning using the memory card is shown in Figure 1-2. The PC-compatible memory card can be used to store measurement files and configuration files. Data extraction from the card requires a

personal computer (PC), where data can be sent from the Data Bucket to the PC over an RS-232 link (up to a 38,400 baud rate), or the card can be removed and taken to a PC equipped with a memory card reader (see Options and Accessories). Memory card operations are discussed in Chapter 3.

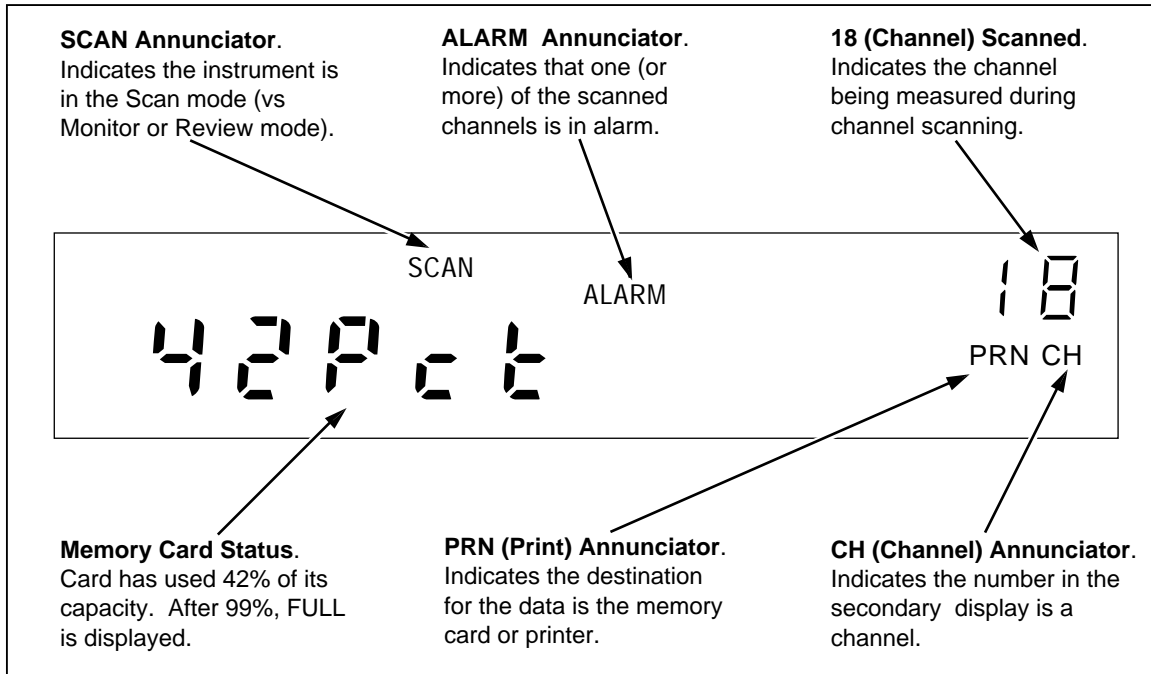

Figure 1-2. Typical Front Panel Display While Scanning

op02f.eps

### Computer Operation

The Data Bucket can serve as a front-end data acquisition unit for PC-based operations, operating over an RS-232 link. The applications software for operating the RS-232 link includes the supplied Hydra Starter Package (Starter) and optional Hydra Logger (Logger) (see "Applications Software" below). Computer operations are discussed in Chapter 4.

### Printer Operation

Measurement data from the Data Bucket can be routed to a printer via an RS-232 link. At the completion of each scan cycle, measurement data is printed, providing hardcopy output. Any compatible printer with a serial input may be used. Printers with a parallel input may be used if they are equipped with a serial-to-parallel adapter. Printer operations are discussed in Chapter 5.

### Modem Operation

An RS-232 link between the Data Bucket and a modem allows data transfers over telephone lines. Operation is similar to computer operations, except there is a modem link instead of a direct RS-232 connection. The modem may be electronic or programmable/electronic (Hayes-compatible). Modem operations are discussed in Chapter 6.

## Measurement Capabilities

Before scanning is enabled, the Data Bucket channels are configured for measuring the selected electrical or physical parameter (volts dc, volts ac, temperature, etc.). Readings have five digits of resolution, for example, 15.388 VAC. Scanning collects measurement data, while the monitor mode can monitor a channel with or without scanning. The review mode stores the maximum, minimum and last readings. Mx+B scaling and alarm attributes can be applied to each configured channel. A totalizer channel is supplied as a separate feature, and digital I/O functions are provided by the rear panel connectors, ALARM OUTPUTS, and DIGITAL I/O.

### Mx+B Scaling

The Mx+B scaling attribute allows readings to be modified to better represent what is being measured. The M represents a multiplier and B represents an offset. For example, a normal reading of 3 volts can be multiplied by  $M=+100$  and offset by  $B=-25$ , to display 275 ( $3 \times 100 - 25 = 275$ ). Mx+B scaling can be applied to any configured channel. This feature is especially useful to scale transducer outputs for exact measurement displays.

### Alarms

The alarms attribute allows readings that rise or fall below preset levels to alert the operator and trigger an action. For example, if you are monitoring temperature and want to have 100°C cause an alarm condition, this can be programmed as part of the channel configuration. Alarm conditions are reported as part of the measurement scan data and can be used to trigger scanning and assert a logic low on a rear panel ALARM OUTPUTS or DIGITAL I/O connector terminal for interface with external equipment. Two alarms can be assigned to any configured channel. If Mx+B scaling is applied, the alarms are based on the scaled values.

### Totalizer Channel

The totalizer channel counts contact closures or voltage transitions. The maximum count is 65,535. The connection is at the rear panel ALARMS OUTPUTS connector, terminals SUM and GROUND. The Data Bucket continuously samples the totalizer input on the rear panel, independently from Hydra's scanning and other activities.

### Alarm Outputs and Digital I/O

Alarm outputs are available on the rear panel ALARM OUTPUTS and DIGITAL I/O connectors. The four ALARM OUTPUT lines are permanently assigned to signal alarms for channels 0, 1, 2, and 3. The eight DIGITAL I/O lines can be used to signal alarm conditions for channels 4 to 20. All input/output lines are transistor-transistor-logic (TTL) compatible. For operations that do not use a computer interface, these are the only functions of the ALARM OUTPUTS and DIGITAL I/O connections. When a computer interface is used, the DIGITAL I/O lines can be assigned in the applications software for a variety of inputs or outputs. The ALARM OUTPUTS can also be assigned for I/O operations if the dedicated alarm function is not used (which has priority).

## Applications Software

PC applications software Hydra Starter (supplied) and Hydra Logger Package (Logger) (optional) operate the instrument via the RS-232 computer interface. The software packages are described in separate technical manuals; however, each is summarized below.

An extensive command set allows the user to develop custom software in GWBASIC, QBASIC, and QuickC. The command set is discussed in Chapter 4.

### **Hydra Starter Package**

Starter is a DOS based, menu-driven software package used to transfer configuration data from and to the instrument, log measurement data collected by the instrument, extract data from the memory card, and manage the acquired data. During operation, Starter displays readings of all channels in real time and can automatically log the data to a Lotus 1-2-3 compatible file.

### **Hydra Logger**

Hydra Logger (model 2635A-901) is an optional Windows-based package that allows complete setup, data collection and data conversion from up to two Hydra units. Logger communicates over the RS-232 port on a personal computer and may be used with telephone models. Hydra Logger with Trending (model 2635A-902) includes a comprehensive trending package that simulates a chart recorder. A brochure with complete details is available.

## **Options and Accessories**

Options and accessories include measurement transducers, cables, applications software, carrying case and other items, all of which are summarized in Table 1-2.

### **Memory Card Reader**

Data Bucket measurement data and configuration setups may be stored on a memory card that is inserted into the slot on the instrument front panel (see Figure 1-1). To review and analyze the recorded data, the memory card data can be routed to a PC via the RS-232 interface, or the memory card can be removed and taken to a PC equipped with a memory card reader. The memory card reader (optional) is external to the PC and connects to a PC parallel port (LPT1, LPT2, etc.). The memory card reader is configured as another PC drive, e.g., the D: drive. Memory card files include data files (dAtxx.HYD) and configuration setups (SEtxx.HYD). The PC manipulates these files using applications software Starter (supplied) and Logger (optional). The selected memory card reader must read SRAM cards and meet Personal Computer Memory Card International Association (PCMCIA)/Japan Electronics Industrial Development Association (JEIDA) standards. This memory card application meets PCMCIA standards release 2.0.

### **Connector Set, 2620A-100**

The 2620A-100 is a complete set of input connectors: one Universal Input Module, one ALARM OUTPUTS connector, and one DIGITAL I/O connector. The use of additional connector sets allows quick equipment interface to several wiring setups.

**Table 1-2. Options and Accessories**

MODEL	DESCRIPTION
2635A-901	Hydra Logger Software (Windows)
2635A-902	Hydra Logger Software with Trending (includes 2640A-904)
2640A-904	Trend Link for Fluke Software
2620A-100	I/O Connector Set; includes Universal Input Module, Digital I/O Connector and Alarm Output Connector
2620A-101	10 Ohm Shunt Set (set of 12 shunts)
263XA-803	Memory Card Reader. Connects to PC parallel printer port
263XA-804	256Kb SRAM Memory Card (one included with instrument)
263XA-805	1Mb SRAM Memory Card
263XA-806	2Mb SRAM Memory Card
263XA-807	4Mb SRAM Memory Card
RS40	RS-232 Cable. DB9 to DB25
RS41	RS-232 Modem Cable. DB9 to DB25
RS42	RS-232 Printer Cable. DB9 to DB25
RS43	RS-232 Cable. DB9 to DB9
C40	Soft Carrying Case
C44	Transit Case
M00-200-634	Rackmount Kit
26XXA-600	Portable Battery Pack
688868	Hydra Series II Service Manual

## ***Setting Up the Instrument***

Setting up the instrument includes all preparatory information, from unpacking the instrument to application of power.

### ***Unpacking and Inspecting the Instrument***

The following items are included in the shipping container:

- Model 2635A Data Bucket instrument
- This manual
- Starter Applications software (floppy disks and manual)
- Universal Input Module
- ALARM OUTPUTS and DIGITAL I/O connectors
- Channel 0 (front panel) TL70A test leads

- Line power cord
- Type "T" Thermocouple
- 256K-byte Memory Card

Carefully remove the instrument from its shipping container and inspect the instrument for possible damage or missing items. If the instrument is damaged or anything is missing, contact the place of purchase immediately. Save the container and packing material in case you have to return the instrument.

Rotate the rear feet of the instrument 180 degrees so that their support pads extend slightly below the bottom of the case.

### Adjusting the Handle

The handle can be positioned to four angles: one for carrying, two for viewing, and one for handle removal. To change the angle, simultaneously pull both handle ends outward to hard stops (about 1/4-inch on each side) and then rotate the handle to one of the four stop positions shown in Figure 1-3. With the handle in the straight-up removal position, you can disengage and free one handle side at a time.

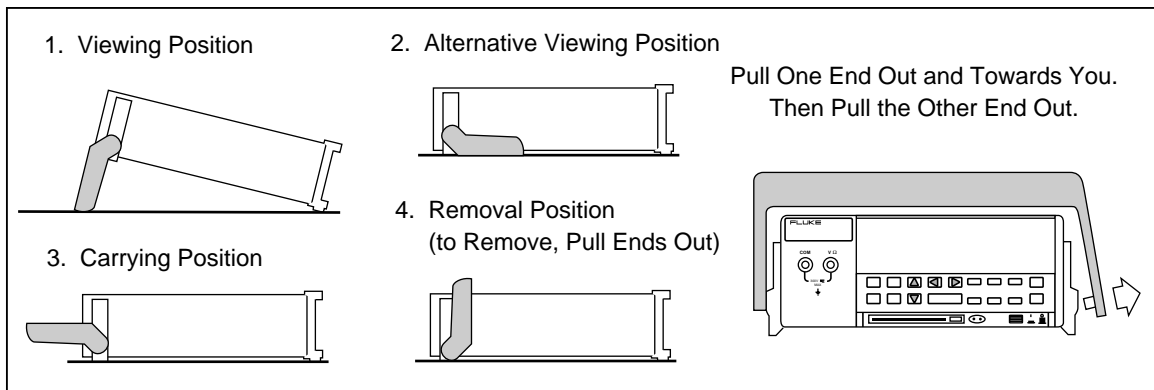
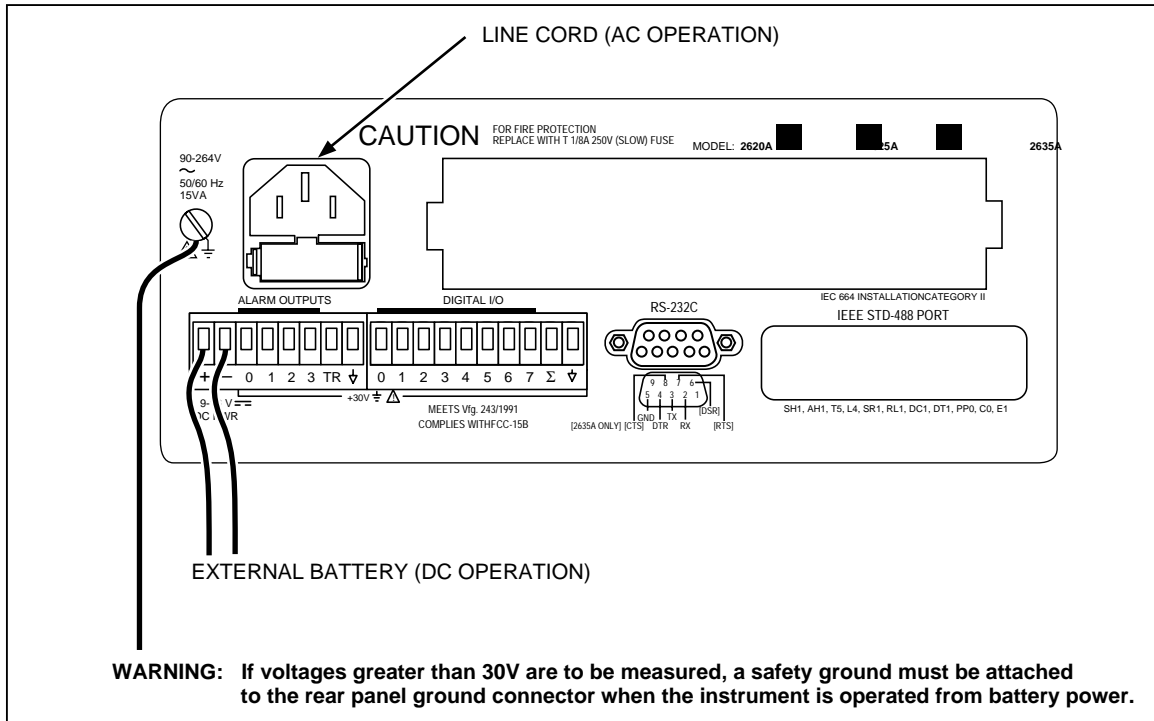

Figure 1-3. Adjusting the Handle

### Connecting the Instrument to a Power Source

The instrument can be connected to an ac or dc source. Connections are shown in Figure 1-4 and described below.



op04f.eps

Figure 1-4. Connecting the Instrument to a Power Source

**Warning**

To avoid shock hazard, connect the instrument power cord to a power receptacle with earth ground.

**AC Operation**

Plug the line cord into the connector on the rear of the instrument. The instrument operates on any line voltage between 90 and 264V ac without adjustment, and at any frequency between 45 and 440 Hz. However, the instrument is warranted to meet published specifications only at 50 or 60 Hz.

**DC Operation**

The instrument may be operated from a DC voltage between 9 and 16 volts, consuming a nominal 4 watts. Connection is made at the rear panel ALARM OUTPUTS connector, pins (+) and (-). If both ac and dc sources are connected simultaneously, ac is used if it exceeds approximately 8.3 times dc. Automatic switchover occurs between ac and dc without interruption.

**Warning**

If voltages greater than 30V are to be measured, a safety ground must be attached to the rear panel ground connector when the instrument is operated from battery power.

**Input Channels**

The instrument provides one input (channel 0) on the front panel and 20 inputs (channels 1 through 20) through a connector on the rear panel. Channels 0, 1, and 11 can measure a maximum of 300V dc or ac rms; all other channels can measure a maximum of 150V dc or ac rms.

### Caution

Do not exceed the specified input voltage levels or equipment damage could result.

## Measurement Connections

### ⚠ Warning

To avoid electric shock:

- When the input module is installed, consider all channels with connections as accessible terminals that may be hazardous live.
- Disconnect the input module before touching or changing external wiring.

Input connections include the front panel terminals (channel 0), rear panel connections using the Universal Input Module (channels 1 through 20), and I/O functions using the ALARM OUTPUTS and DIGITAL I/O connectors. The instrument is protected from channel configuration errors. For example, accidentally applying 300V ac to a channel configured for resistance measurements will not damage the instrument.

### Using Shielded Wiring

Shielded wires and sensors (such as thermocouples) should be used in environments where "noisy" voltage sources are present. When shielded wiring is used, the shield is normally connected to the L (low) input terminals for each channel. Alternate configurations should be examined for each equipment application.

### Crosstalk

The instrument allows the mixing of various types of measurement. A phenomenon known as crosstalk can cause one signal to interfere with another and thereby introduce measurement errors. To reduce the effects of crosstalk in making measurement connections, do the following:

- Keep any input wiring carrying ac volts signals physically separate from the input wiring of other sensitive channels.
- Avoid connecting inputs with ac volts signals adjacent to sensitive channel inputs. Leave unconnected channels between the inputs, if possible.
- Avoid connecting inputs with ac volts signals to any channel 10 numbers away from a sensitive channel (i.e., 4-terminal input channels).
- Avoid tying L (low) or (especially) H (high) inputs of a sensitive channel to earth (chassis) ground. This is very important in resistance measurements.
- Avoid high-source impedances on sensitive channels, or minimize the capacitance of the sensitive channel to earth (chassis) ground for high impedance inputs.
- Whenever high ohms measurements ( $>10\text{ k}\Omega$ ) must be made accurately, avoid connecting any inputs carrying ac volts signals.

Measurement errors introduced by crosstalk are discussed in Appendix B.

### Universal Input Module Connections

For channels 1 through 20, use the H (high) and L (low) inputs on the rear panel Universal Input Module, as shown in Figure 1-5. Perform the following procedure to make connections to the Universal Input Module:



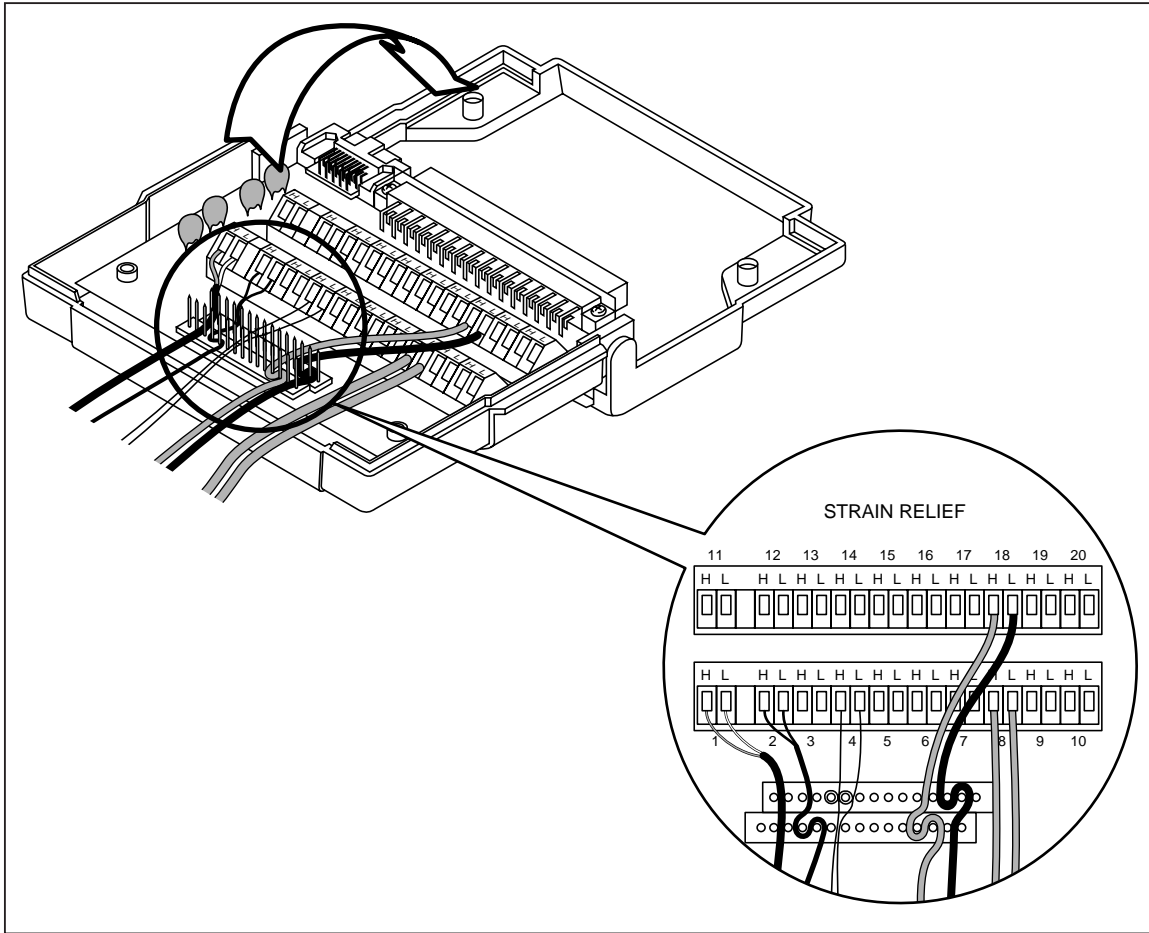

Figure 1-5. Universal Input Module Connections

op05f.eps

**⚠ Warning**

**Inputs may be connected to live voltages. To avoid electric shock, remove inputs from live voltages before opening this module.**

1. Remove the module from the rear panel by pressing the release tab on the bottom of the module and then pulling the module out of its connector.
2. Loosen the two large screws on top and open the module
3. Connect the wires to H (high) and L (low) for each channel.
4. Thread these wires through the strain-relief pins and out the back of the module.
5. Close the module cover, secure the screws, and insert the module in the connector at the rear of the instrument until it latches in place.

*Note*

*Channel 0 on the front panel does not support thermocouple measurements.*

Resistance and RTD measurements can be made with two terminals (one channel) or four terminals (two channels). The four-terminal connection provides increased accuracy (nominal 1%) over the two-terminal connection. Refer to Figure 1-6.

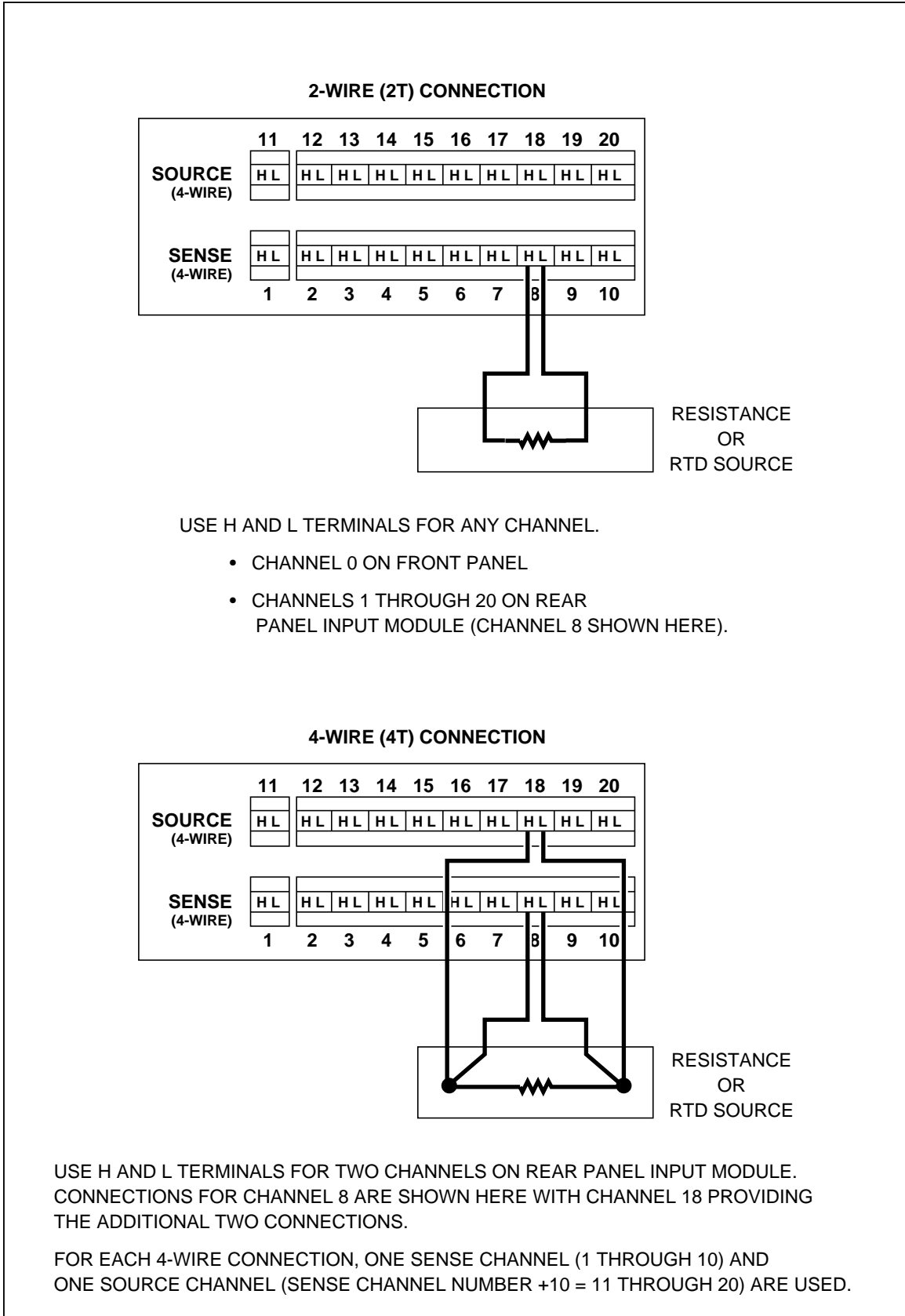

op06f.eps

Figure 1-6. Two-Terminal and Four-Terminal Connections

### Alarm Outputs Connections

The eight-terminal rear panel ALARM OUTPUTS connector (Figure 1-7) serves three functions: DC power, alarm outputs, and external trigger input. Each is described below.

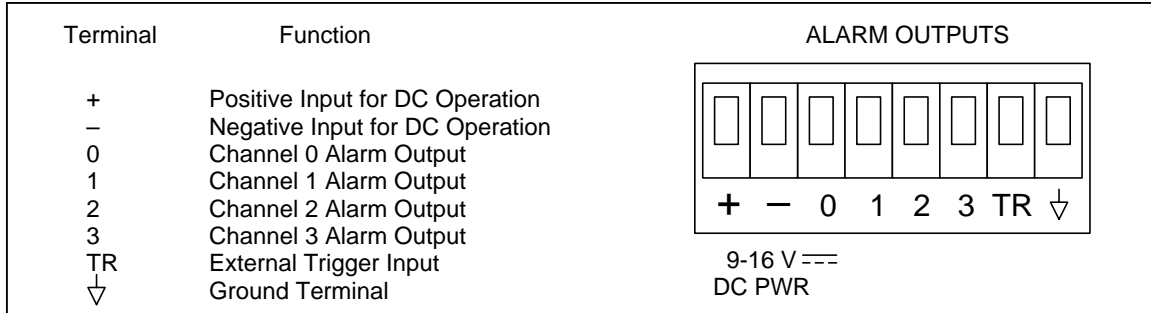

op07f.eps

**Figure 1-7. ALARM OUTPUTS connector**

#### DC Power

The instrument may be powered by a dc input between 9 volts and 16 volts allowing remote operation from various battery sources or dc power supplies. Connect the positive lead of the power supply to the + terminal and the negative lead to the - terminal. If the instrument is going to measure voltages greater than 50 volts dc or ac rms, also connect a ground wire between the rear panel ground lug and a suitable earth (safety) ground point (see Figure 1-4).

#### Alarm Outputs

Terminals 0, 1, 2, and 3 are used to signal alarm conditions for channels 0, 1, 2, and 3 respectively using transistor-transistor-logic (TTL) voltage levels, referenced to the GROUND terminal. Logic high is  $>+2.0$  to  $<+5.5$  V dc; a logic low is 0.0 to  $+0.8$  V dc. If a channel is not in alarm, the voltage output at a connector terminal is a logical high (nominal +5V dc); if a channel is in alarm, the output is a logical low (nominal  $+0.7$  V dc). Alarm outputs are set at the end of a scan interval. See *Setting the Alarms* in Chapter 2 for more information. If the instrument is operated over the RS-232 computer interface, the ALARM OUTPUTS can be assigned to I/O functions (assuming channels 0, 1, 2, and 3 are not configured for alarms). See the ALARM\_DO\_LEVEL command, described in Chapter 4.

#### External Trigger Input

An external trigger input can serve the same function as the front panel SCAN key. A contact closure between TR and GROUND or a TTL logical low applied to TR (referenced to GROUND), will cause the instrument to scan. When the trigger input is removed, scanning will stop. Scanning is initiated on the falling edge of the trigger signal, which must be held logic low for at least 5  $\mu$ s and have been preceded by at least 100 ms of logic high. Logic high is  $+2.0$  to  $+7.0$  V dc; a logic low is  $-0.6$  to  $+0.8$  V dc. See "Scan Triggering Options" in Chapter 2 for more information.

Perform the following procedure to make connections to the ALARM OUTPUTS connector:

1. Remove the connector from the rear panel.

2. Loosen the wire clamp screw for the associated terminal.
3. Feed the wire into the gap between the connector body and the wire clamp.
4. Tighten the wire clamp screw.
5. Insert the connector in the rear panel.

### Digital I/O Connections

The ten-terminal rear panel DIGITAL I/O connector (Figure 1-8) serves two functions: Digital I/O and Totalizer input. Each is described below.

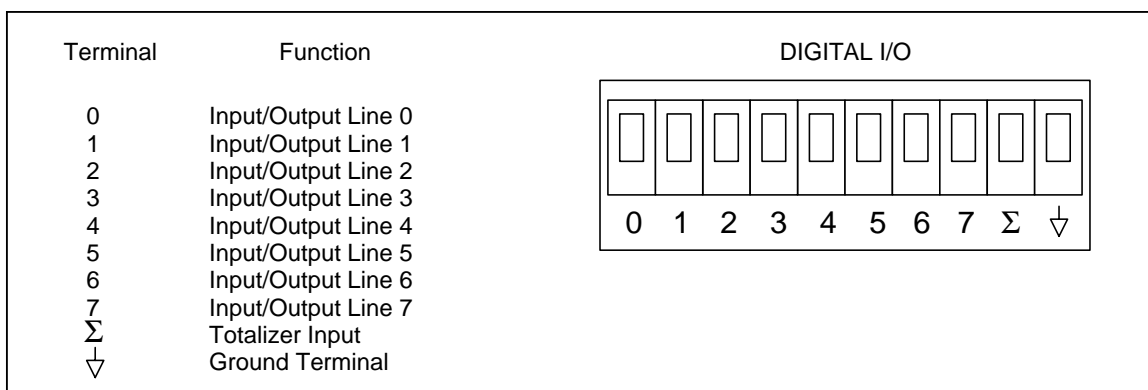

Figure 1-8. DIGITAL I/O Connector

op08f.eps

### Digital I/O

Terminals 4 through 7 are used to signal alarm conditions for channels 4 through 20 (default setting) using TTL voltage levels, referenced to the GROUND terminal. Logic high is  $>+2.0$  to  $<+5.5$  V dc; a logic low is 0.0 to  $+0.8$  V dc. If a channel is not in alarm, the voltage output at a connector terminal is a logical high (nominal +5V dc); if a channel is in alarm, the output is a logical low (nominal +0.7V dc). Alarm outputs are changed at the end of each scan. See "Setting the Alarms" in Chapter 2 for more information. All alarm associations can be removed using computer commands, allowing the I/O terminals to be assigned to other functions as determined by computer commands. See the ALARM\_ASSOC\_CLR and related commands, described in Chapter 4.

### Totalizer Input

The totalizer is an internal counter that sums contact closures or voltage transitions. Connection is to the SUM terminal, referenced to GROUND. A contact closure and opening, or a voltage transition rising edge will cause the totalizer to advance by one count. The maximum count allowed is 65535 and the maximum count rate is 5 kHz. Voltages trigger on a low-to-high transition at a nominal threshold of +1.4 volts. A contact debounce feature is available when the instrument is operated through the RS-232 computer interface using the TOTAL\_DBNC command, described in Chapter 4.

Perform the following procedure to make connections to the DIGITAL I/O connector:

1. Remove the connector from the rear panel.
2. Loosen the wire clamp screw for the associated terminal.
3. Feed the wire into the gap between the connector body and the wire clamp.

4. Tighten the wire clamp screw.
5. Insert the connector in the rear panel.

## Controls and Indicators

The front panel (Figure 1-1) provides a multipurpose display and a set of control keys. Each is described in the following paragraphs.

### Front Panel Controls

The front panel keys (Figure 1-9) control all instrument operation: channel configuration, instrument configuration, measurement functions, and print/communications selections. Table 1-3 provides a summary of front panel key functions.

### Front Panel Indicators

The front panel indicators are divided into three portions: Primary Display (Figure 1-10), Secondary Display (Figure 1-11), and Display Annunciators (Figure 1-12). Table 1-4 describes each annunciator function.

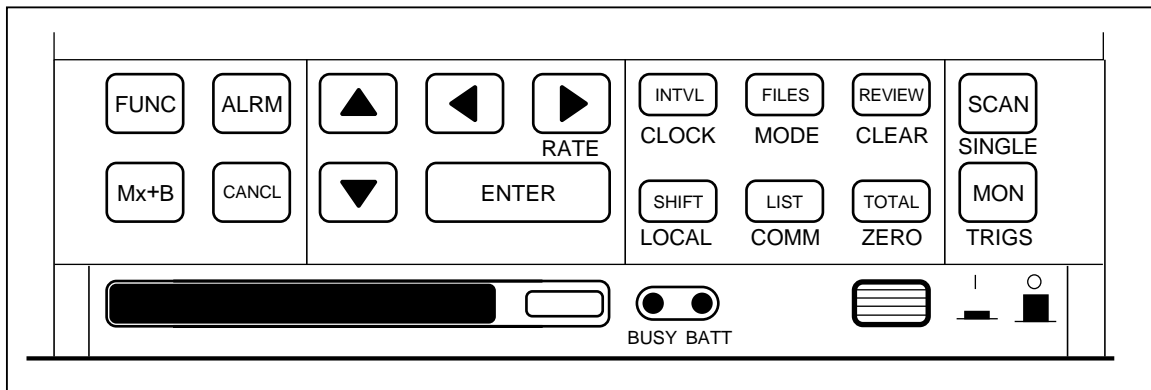

Figure 1-9. Front Panel Keys

op09f.eps

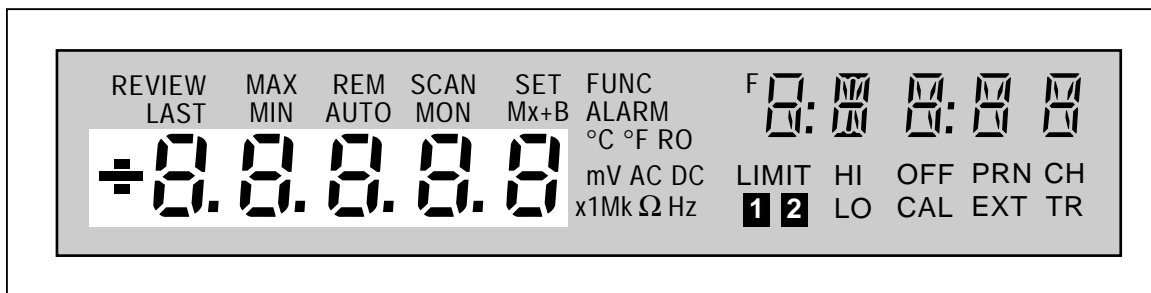

Figure 1-10. Primary Display

op10f.eps

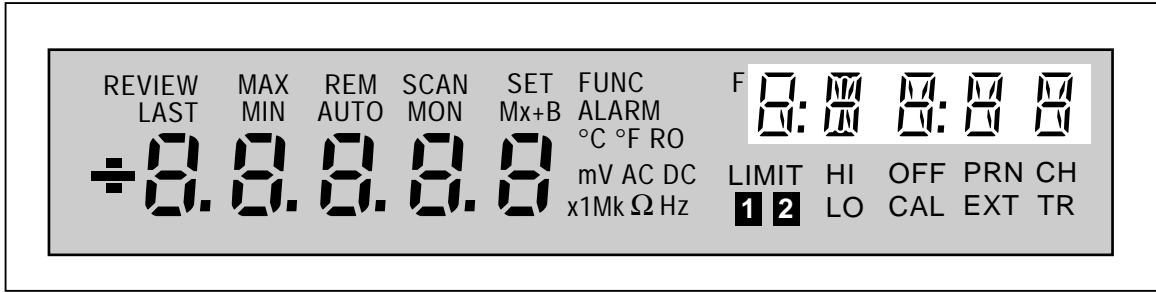

Figure 1-11. Secondary Display

op11f.eps

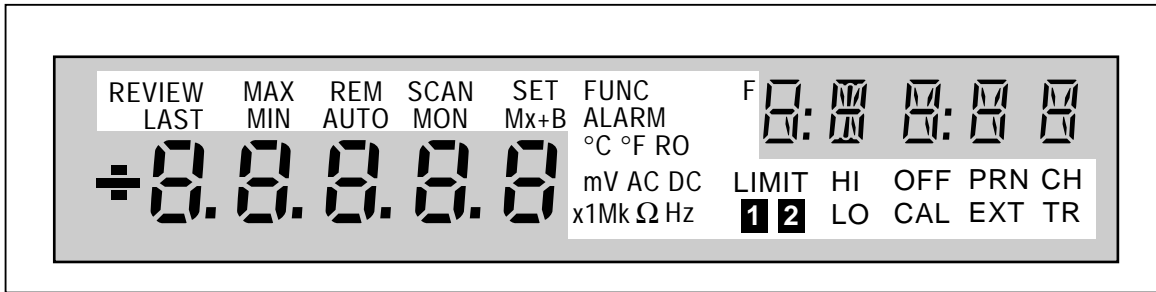











Figure 1-12. Annunciator Display

op12f.eps



**Table 1-3. Front Panel Keys Description**

Key	Description
FUNC	Calls up the menu to set the function for the channel
ALRM	Calls up the menu to set alarm limits <b>1</b> and <b>2</b> for the channel.
Mx+B	Calls up the menu to set scaling on the channel.
CANCL	<p>Used to exit any setup menu and return to Inactive Mode, without saving settings you've selected thus far. Exceptions exist under the following two conditions</p> <p>If you cancel out of the alarm menu part way through defining alarm limit <b>2</b>, any just-made entries for alarm limit <b>1</b> will still take effect.</p> <p>If you cancel out of the Mx+B menu part way through defining the B value, any just-made entries for the M value will still take effect.</p> <p>This key also provides a handy way to remove the Totalizer value or Review data from the display.</p>
▲ ▼	Used to change the channel number and to step through choices in any of the setup menus. These arrow keys have an automatic repeat action when held down for more than 1 second.
▶ ◀	Used to step through choices in several of the setup menus. These arrow keys have an automatic repeat action when held down for more than 1 second.
ENTER	Used to accept a selection just made in any setup menu.
INTVL	Allows you to change the scan interval. Scanning becomes continuous when the interval is set to 0:00:00.
FILES	Accesses menus related to memory card operation, including status, directory, and manipulation of all SEtxx and dAtxx files.
REVIEW	Calls up the Review array of MIN, MAX and LAST values to the display.
SHIFT	Accesses secondary functions under various keys, as described below. When this key is pressed, "SHIFT" appears on the right display, but automatically disappears if you have not made a selection within 5 seconds or press CANCL.
LIST	Prints out the Last values of the Review array or contents of the memory card directory via the RS-232 computer interface.
TOTAL	Calls up the present Totalizer count to the display.
SCAN	<p>Turns the Scan function on or off.</p> <p>Triggers a single scan when the instrument is under remote control without lockout (REMS).</p>
MON	Turns the Monitor function on or off
RATE SHIFT ▶	Allows you to change the scanning speed: "Slo" for highest accuracy, or "FAST" for highest throughput
CLOCK SHIFT INTVL	Allows you to set the internal day/date clock
MODE SHIFT FILES	Allows you to select the destination and conditions for which scan measurements will be automatically printed or logged.

**Table 1-3. Front Panel Keys Description (cont.)**

Key	Description
CLEAR  	This key sequence clears the entire contents of the Review array. Review data must be presently shown on the display to clear the array.
LOCAL 	When under remote control without lockout (REMS), this returns control to the front panel.
COMM  	Allows you to set up the computer interface port.
ZERO  	While the Totalizer count is displayed, resets the Totalizer to 0.
SINGLE  	Forces an immediate scan of all defined channels. If a scan is presently in progress, this new request is ignored. Once begun, the full scan is completed. Configuration changes are not allowed while a scan is in progress.

**Table 1-4. Annunciator Descriptions**

Annunciator	Description
MON	Indicates that the Monitor function is enabled.
SCAN	Indicates that the Scan function is enabled. Scanning can be enabled as a single scan (   ) , with a scan interval, with an alarm-trigger or with an external trigger.
CH	Indicates that the channel number is displayed immediately above, in the right display.
SET	Lit when the instrument is in Configuration Mode.
Mx+B	Lit while Mx+B scaling is being defined and when a measurement on the display has been scaled with an M value other than 1 and/or a B value other than 0 has been defined for this channel.
FUNC	Lit when a measurement function is being defined for this channel.
ALARM	Lit when alarm values are being defined for this channel or when an alarm limit has been exceeded while measuring.
v	Indicates that the measurement function is volts for this channel (used with the AC or DC annunciator).
DC	Indicates that the measurement function is dc voltage for this channel.
AC	Indicates that the measurement function is ac voltage for this channel.
$\Omega$	Indicates that the measurement function is resistance for this channel.
Hz	Indicates that the measurement function is frequency for this channel.
°C	Indicates that the measurement function is temperature for this channel and that the degree unit is Celsius.
°F	Indicates that the measurement function is temperature for this channel and that the degree unit is Fahrenheit.
m	(milli) a multiplier for the displayed value, e.g., mV for millivolts. Also used when defining alarm and Mx+B values.
x1	(times 1) a multiplier for the displayed value. Used when defining alarm and Mx+B values.
k	(kilo) a multiplier for the displayed value, e.g., kHz for kilohertz. Also used when defining alarm and Mx+B values.



**Table 1-4. Annunciator Descriptions (cont)**

Annunciator	Description
M	(mega) a multiplier for the displayed value, e.g., M½ for megohms. Also used when defining alarm and Mx+B values.
R0	Lit when the ice point resistance is being defined for RTD measurements on the displayed channel.
OFF	Indicates there is no measurement function defined for the displayed channel; OFF channels are skipped over when scanning. OFF is also used when defining an alarm value to indicate that the alarm limit is to be ignored.
AUTO	Indicates that autoranging is enabled for the displayed channel.
LIMIT	Used with the [1] and [2] annunciators when you are setting an alarm limit value. Also lit when displaying a measurement value (LAST, Monitor) which has exceeded an alarm limit.
1	Lit when alarm limit 1 is being defined. Also lit when displaying a measurement value (LAST, Monitor) which has exceeded alarm limit 1.
2	Lit when alarm limit 2 is being defined. Also lit when displaying a measurement value (LAST, Monitor) which has exceeded alarm limit 2.
HI, LO	Identifies alarm limit sensing (high or low) during channel configuration. At other times, identifies an alarm condition.
REVIEW	Indicates that review data is being displayed (used in conjunction with the MIN, MAX, and LAST annunciators).
MIN, MAX	Indicates that the displayed value is the minimum (maximum) value measured on this channel.
LAST	Indicates that the displayed value is the most recent scan measurement taken on this channel.
PRN	Indicates that the autoprint function is enabled (to send readings to a printer or PC) or the memory storage function is on (to store readings in a memory card).
EXT	Indicates that external triggering (on the rear panel) is enabled.
TR	Indicates that internal triggering (from the monitor alarm) is enabled. Also used with EXT when external triggering is enabled.
REM	Indicates that the instrument is under the control of the RS-232 computer interface (bright) or a front panel lockout option has been enabled (dim).
CAL	Indicates that the instrument's internal calibration constants have been corrupted.
F	(Not Used)



## **Chapter 2**

# **Front Panel Operations**

<b>Title</b>	<b>Page</b>
Summary of Front Panel Operations .....	2-5
Configuring the Instrument for Operation.....	2-6
Turning the Power on.....	2-6
Selecting a Channel.....	2-8
Configuring a Measurement Channel.....	2-8
Configuring a Channel to Measure DC Volts.....	2-9
Configuring a Channel to Measure AC Volts.....	2-10
Configuring a Channel to Measure Resistance.....	2-11
Configuring a Channel to Measure Frequency.....	2-12
Configuring a Channel to Measure Temperature.....	2-13
Thermocouples .....	2-13
Resistance-Temperature Detectors .....	2-13
Thermocouple Restrictions:.....	2-13
Resistance Temperature Detectors Restrictions:.....	2-13
Configuring a Channel Off .....	2-16
Setting Operating Conditions .....	2-16
Setting the Scan Interval .....	2-17
Setting the Measurement Rate .....	2-18
Setting the Alarms.....	2-18
Alarm Indications While Scanning.....	2-18
Alarm Indications While Monitoring .....	2-19
Alarm Indications While Reviewing .....	2-19
Clearing Alarm Parameters from a Channel.....	2-19
Alarm Outputs for Channel 0 to 3 Using the Alarm Outputs Connector .	2-19
Alarm Outputs for Channels 4 to 20 Using the Digital I/O Connector ....	2-19
Alarms and Autoprinting .....	2-20
Alarms and Monitor-Alarm Triggering .....	2-20
Alarms and Mx+B Scaling .....	2-20
Setting the Mx+B Scaling.....	2-23
Examples.....	2-23
Restrictions .....	2-23
Clearing Mx+B Scaling from a Channel .....	2-23
Operating Modes .....	2-26
Using the Scan Mode .....	2-26
Memory Card as a Data Destination.....	2-26

Memory Card Formatting .....	2-26
Memory Card Capacity.....	2-26
Memory Card Files .....	2-26
Memory Card Exchange During Scanning.....	2-26
Memory Card Data Extraction.....	2-27
Memory Card Error Messages .....	2-28
Using the Monitor Mode.....	2-29
Using the Review Mode.....	2-30
Additional Features .....	2-31
Scan Triggering Options .....	2-31
External Trigger.....	2-31
Monitor-Alarm Trigger.....	2-31
Triggering Options and Memory Card Operation .....	2-31
Totalizer Operation .....	2-32
Digital Input/output Lines .....	2-33
Setting Date and Time.....	2-34
Reading Instrument Software Versions .....	2-35
Returning to the Local Mode .....	2-35
Front Panel Key Lockout Options .....	2-36
Instrument Interfaces .....	2-36
Memory Card Interface .....	2-36
RS-232 Computer Interface .....	2-37
Using the RS-232 Computer Interface With a Printer .....	2-37
Using the RS-232 Computer Interface With a Modem.....	2-37



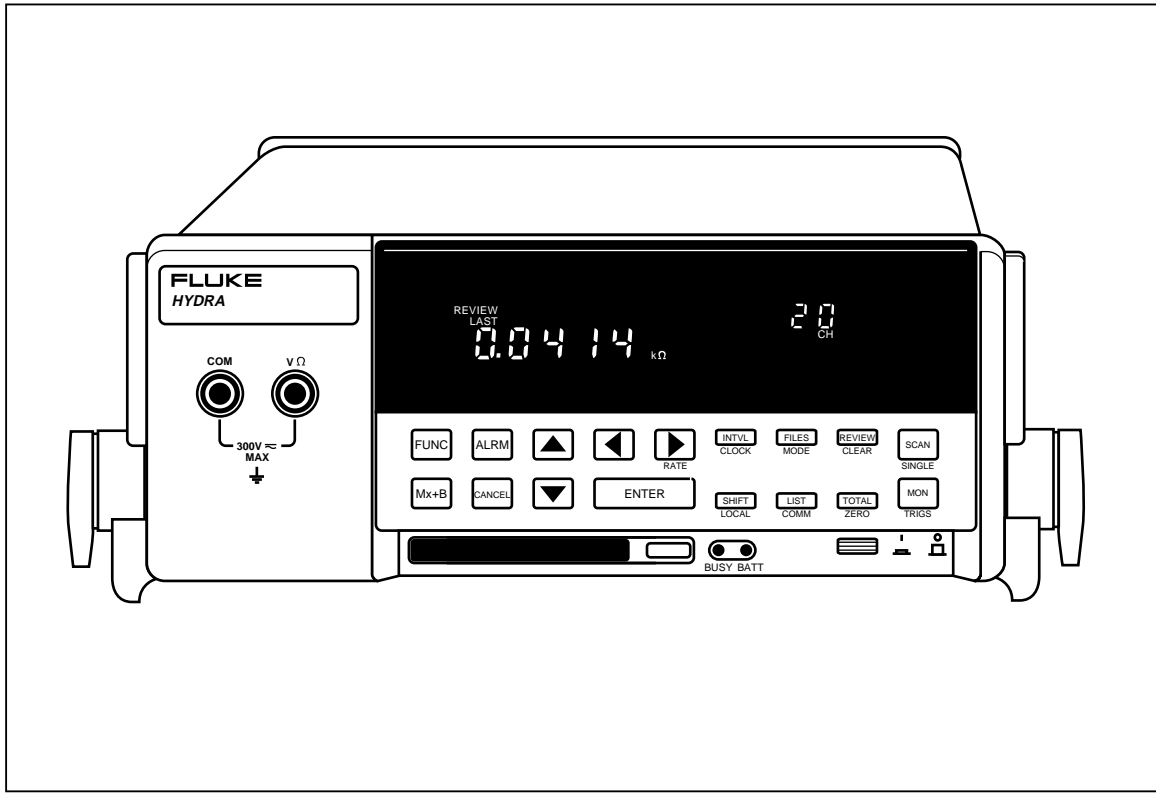

op92f.eps

## Summary of Front Panel Operations

Descriptions of all equipment operations start at the front panel and proceed through the following topics, which appear in the following sequence:

- Preparing for Operation
- Configuring a Measurement Channel
- Setting Operating Conditions
- Operating Modes
- Additional Features
- Instrument Interfaces

This chapter applies exclusively to instrument applications that use only the front panel controls and annunciators. Other chapters apply specifically to applications that use the memory card feature or interface with a computer, printer, or modem. It is assumed that the user has understood the information in Chapter 1, "Preparation for Use," including such topics as setting up the instrument and making measurement connections. Perform the Ten-Minute Tour at the front of this manual for a quick overview of instrument operation.

All the procedures in this chapter use control/annunciator diagrams that provide the control sequences and expected indicators for each operation. A summary of how to use the control/annunciator diagrams is shown in Figure 2-1.

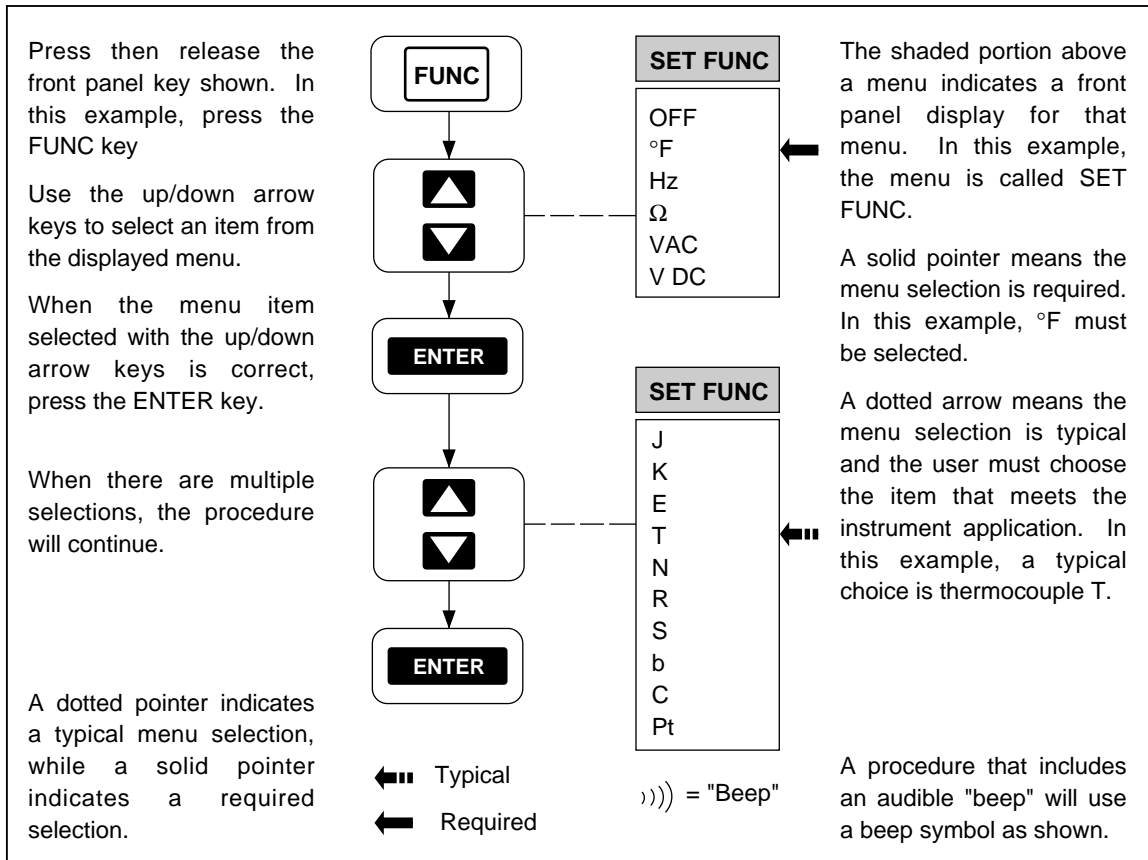

Figure 2-1. How to use the Control/Annunciator Diagrams

op13f.eps

## Configuring the Instrument for Operation

To prepare the equipment for front panel operations, perform the two following procedures:

- Turning the Power On (Figure 2-2)
- Selecting a Channel (Figure 2-3)

### Turning the Power on

There are four power-on options. Figure 2-2 describes the control sequences for each option.

Each power-on sequence includes a four-second selftest routine that lights the front panel display. If the selftest fails, the instrument will beep and display ERROR plus an alphanumeric error code character (see Table 2-2). If there is more than one error, each is displayed in sequence at two-second intervals. Refer to the maintenance information in Chapter 7 for guidance on what to do when an error is detected.

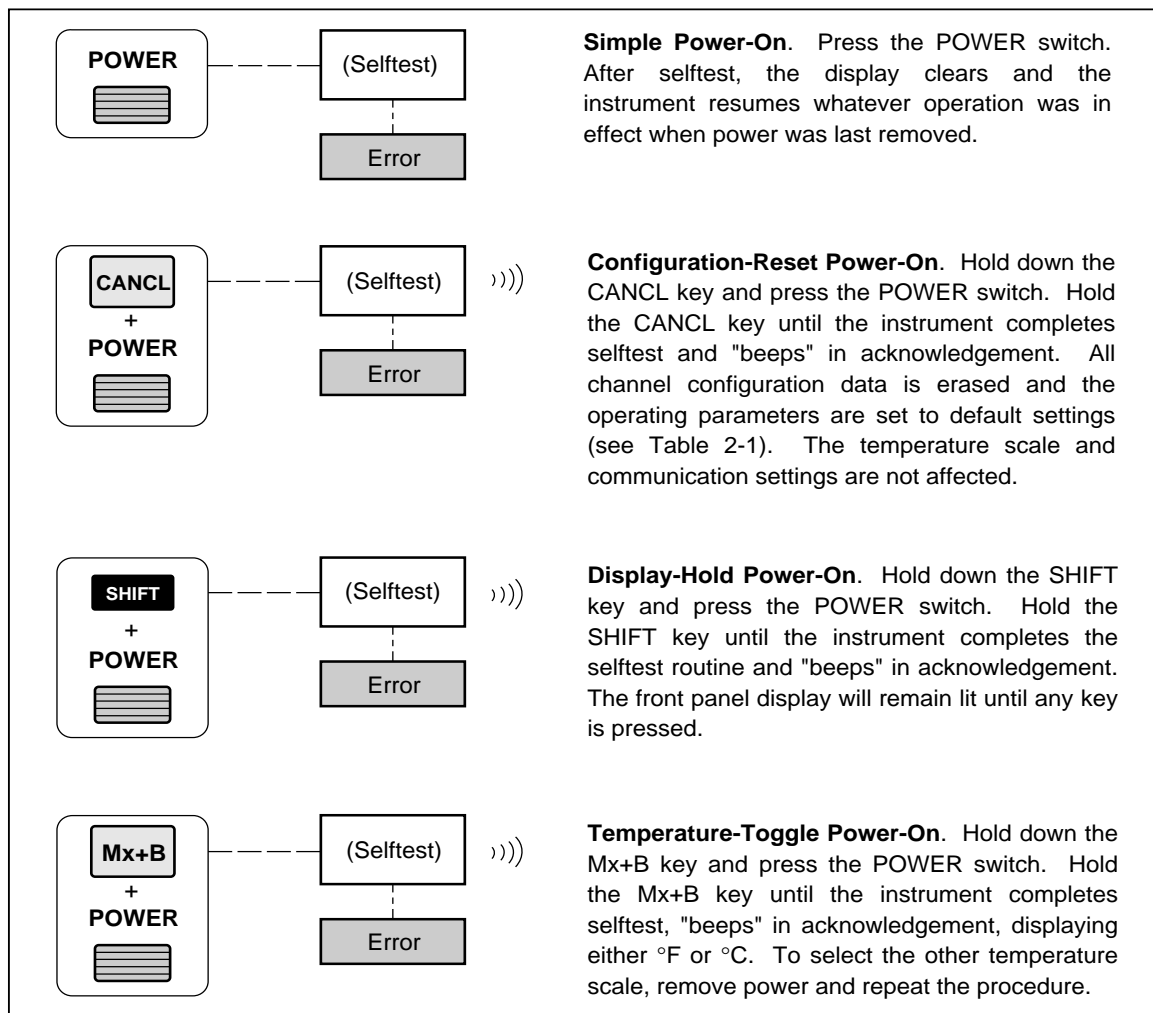

Figure 2-2. Turning the Power On

op14f.eps



**Table 2-1. Configuration Reset (Default) Settings**

Parameter	Default Setting
Channels 0 to 20	Off
Measurement Rate	Slow
Mx+B Scaling	1x+0 (all channels)
Scan Interval	0:00:00 (continuous)
Review Values	Cleared (all channels)
Digital I/O Lines	Set High (non-alarm)
Totalizer	0/Debounce Disabled
Destination	None
RTD R0	100.00 (all channels)
Open Thermocouple Detection (OTC)	Enabled
Alarm Limits	Off/Limit Values=0
Alarm Assignments	Channels 0 to 3, to ALARM OUTPUTS 0 to 3. Channels 4 to 20, to DIGITAL I/O as below: DIGITAL I/O LINE    4   5   6   7  Alarm Channel        4   5   6   7 (ORed to drive       8   9   10 11 each I/O line)       12 13 14 15 16 17 18 19 20

**Table 2-2. Selftest Error Codes**

Code	Description
1	Boot ROM Checksum Error
2	Instrument ROM Checksum Error
3	Internal RAM Test Failed
5	Display Power-Up Test Failed
6	Display Not Responding
7	Instrument Configuration Corrupted
8	Instrument Not Calibrated
9	A-to-D Converter Not Responding
A	A-to-D Converter ROM Test Failed
b	A-to-D Converter RAM Test Failed
C	A-to-D Converter Selftest Failure
d	Memory Card Interface Not Installed

### Selecting a Channel

There are 21 channels, 0 to 20. A channel is selected for configuration or configuration verification when the instrument is in the inactive mode. An active channel is selected for monitoring when the instrument is in the Monitor Mode (see Figure 2-17) or Review Mode (see Figure 2-18). Perform the procedure in Figure 2-3 to select a channel.

### Restrictions

**Locked Out Channels.** Any channel 1 to 10 (n) assigned to four-terminal (4T) measurements locks out a corresponding channel a decade higher (n+10). For example, use of channel 3 for 4T measurements locks out channel 13, which can be selected, but not configured.

**Restricted Channels.** Channel 0 (front panel terminals) does not support thermocouple measurements or four-terminal measurements.

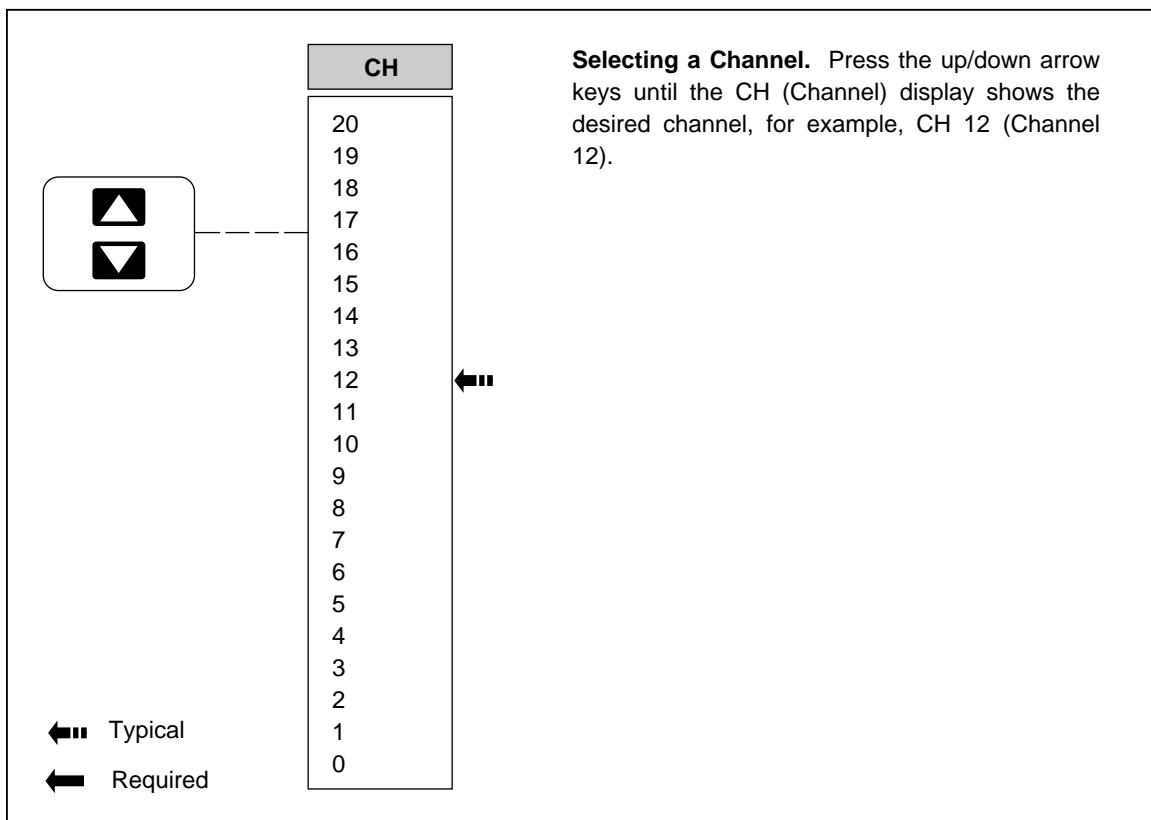

Figure 2-3. Selecting a Channel

op15f.eps

### Configuring a Measurement Channel

The following paragraphs provide configuration procedures for DC Volts, AC Volts, Resistance, Frequency, Temperature, and describe how to turn a channel Off:

- Configuring a Channel to Measure DC Volts (Figure 2-4)
- Configuring a Channel to Measure AC Volts (Figure 2-5)
- Configuring a Channel to Measure Resistance (Figure 2-6)
- Configuring a Channel to Measure Frequency (Figure 2-7)

- Configuring a Channel to Measure Temperature (Thermocouples) (Figure 2-8)
- Configuring a Channel to Measure Temperature (RTDs) (Figure 2-9)
- Configuring a Channel Off (Figure 2-10)

The instrument is protected from channel configuration errors. For example, accidentally applying 300V ac to a channel configured for resistance will not damage the instrument.

### Configuring a Channel to Measure DC Volts

Perform the procedure in Figure 2-4 to configure a channel for measuring dc volts. In preparation, the instrument must be in the inactive mode (not scanning or monitoring) and the desired channel must be selected (see Figure 2-3). To exit at any time (changes not saved), press the **CANCL** key.

#### Restrictions

**Maximum Input.** The maximum voltage inputs are 300V dc for channels 0, 1, 11, and 150V dc for channels 2 to 10, and 12 to 20.

**90.000 mV Range.** Not used in Auto (autoranging).

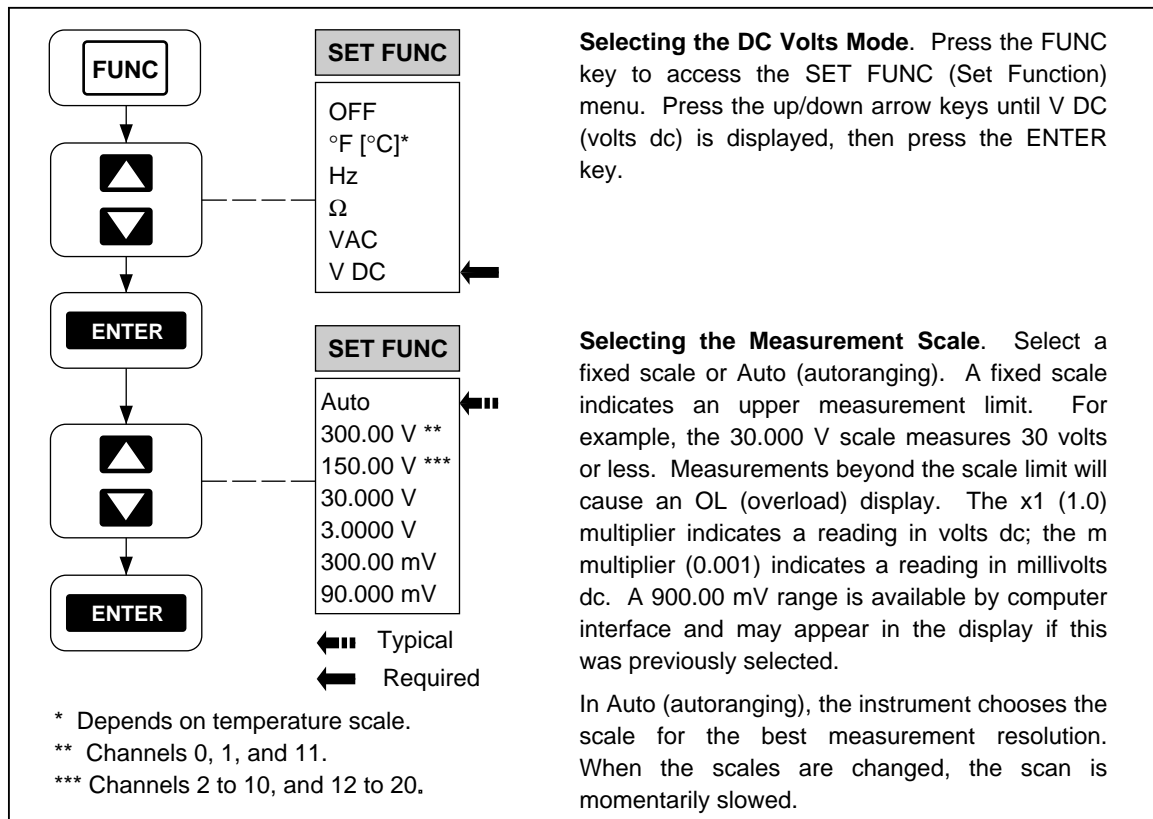

Figure 2-4. Configuring a Channel to Measure DC Volts

op16f.eps

### Configuring a Channel to Measure AC Volts

Perform the procedure in Figure 2-5 to configure a channel for measuring ac volts. In preparation, the instrument must be in the inactive mode (not scanning or monitoring) and the desired channel must be selected (see Figure 2-3). To exit at any time (changes not saved), press the **CANCL** key.

#### Restrictions

**Maximum Input.** The maximum voltage inputs are 300V ac (rms) for channels 0, 1, 11, and 150V ac (rms) for channels 2 to 10, and 12 to 20.

**Frequency.** The frequency range for maximum voltage inputs is 20 Hz to 100 Hz. Refer to Appendix A for derated voltage inputs for frequencies between 100 Hz and 100 kHz.

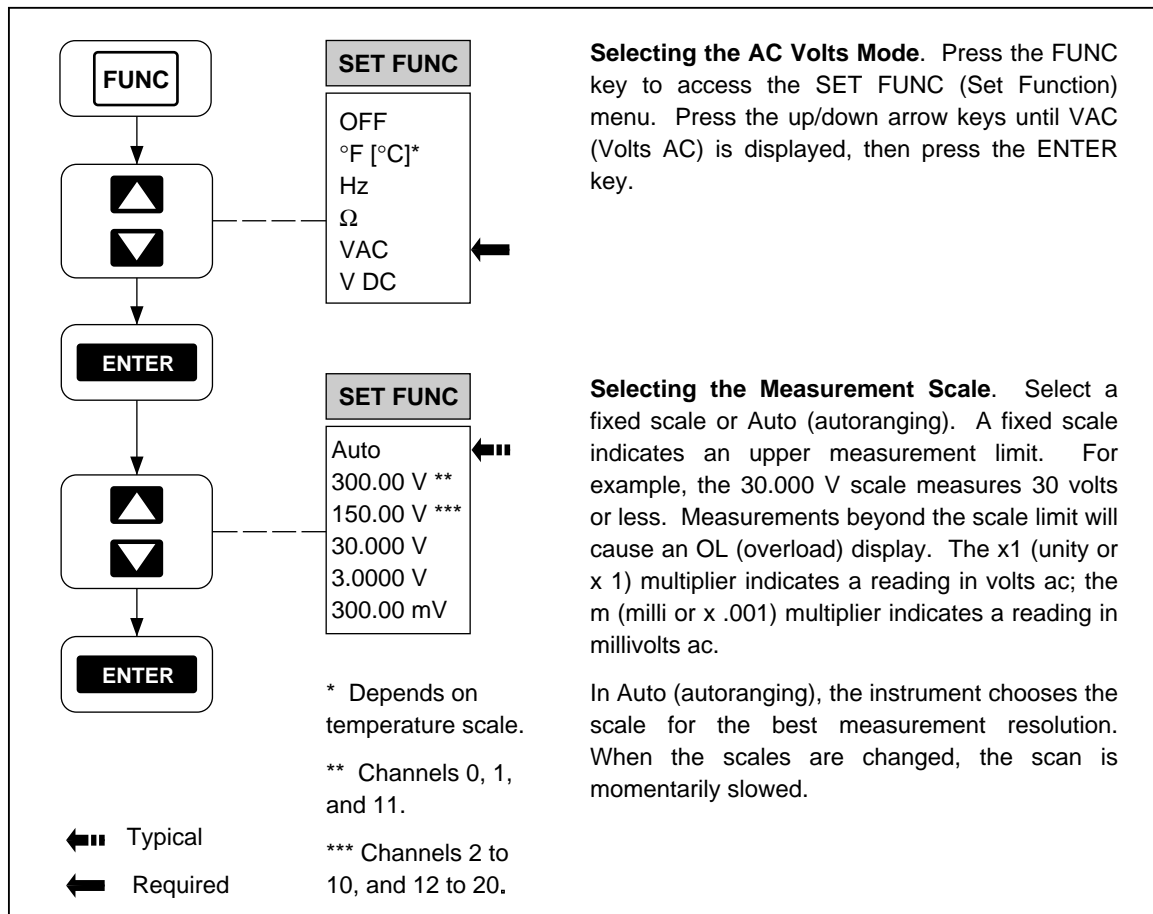

Figure 2-5. Configuring a Channel to Measure AC Volts

op17f.eps

### Configuring a Channel to Measure Resistance

Perform the procedure in Figure 2-6 to configure a channel for measuring resistance. In preparation, the instrument must be in the inactive mode (not scanning or monitoring) and the desired channel must be selected (see Figure 2-3). To exit at any time (changes not saved), press the **CANCL** key.

The resistance to be measured can be connected using one channel (two-terminal connection) or two channels (four-terminal connection). The four-terminal connection provides increased measurement precision. The two channels used in a four-terminal connection are a decade apart ( $n$  and  $n+10$ ), for example, channel 3 ( $n$ ) and 13 ( $n+10$ ). Only the lower channel is configured.

#### Restrictions

**Four-Terminal Channels.** Four-Terminal configurations are limited to channels 1 to 10 ( $n$ ). The channel a decade higher ( $n + 10$ ) is automatically reserved for use.

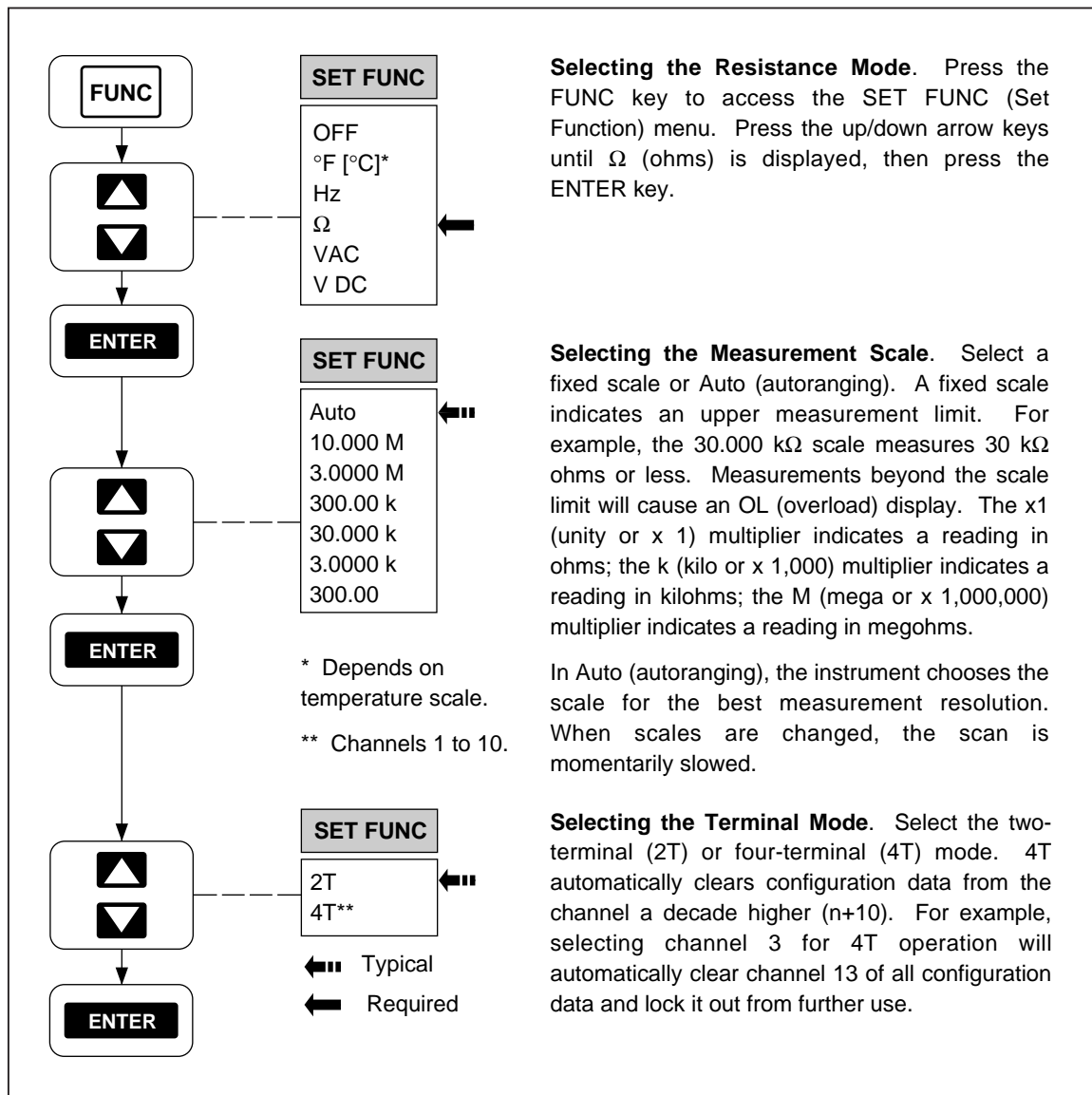

Figure 2-6. Configuring a Channel to Measure Resistance

op18f.eps

### Configuring a Channel to Measure Frequency

Perform the procedure in Figure 2-7 to configure a channel for measuring frequency. In preparation, the instrument must be in the inactive mode (not scanning or monitoring) and the desired channel must be selected (see Figure 2-3). To exit at any time (changes not saved), press the **CANCL** key.

#### Restrictions

**Frequency Range.** The frequency range for measurements is 15 Hz minimum to greater than 1 MHz.

**Maximum Input.** The maximum voltage inputs are 300V ac (rms) for channels 0, 1, 11, and 150V ac (rms) for channels 2 to 10, and 12 to 20. The frequency range for maximum voltage inputs is 15 Hz to 100 Hz. Refer to Appendix A for derated voltage inputs for frequencies between 100 Hz and 100 kHz.

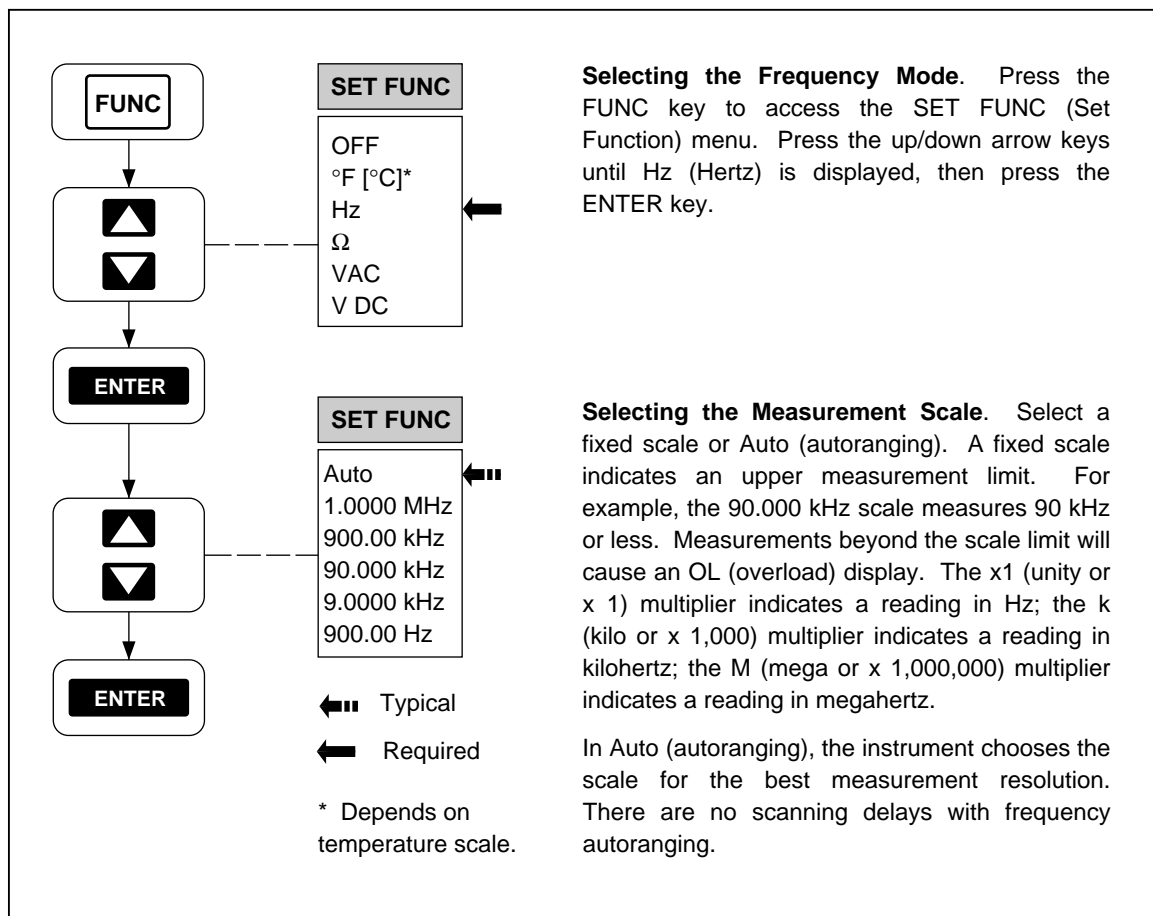

Figure 2-7. Configuring a Channel to Measure Frequency

op19f.eps

### **Configuring a Channel to Measure Temperature**

Perform the procedure in Figure 2-8 to configure a channel for measuring temperature with thermocouples, or Figure 2-9 to measure temperature with resistance-temperature detectors (RTDs). In preparation, the instrument must be in the inactive mode (not scanning or monitoring) and the desired channel must be selected (see Figure 2-3). To exit at any time (changes not saved), press the **CANCL** key. The temperature scale, °C or °F, is set by the Temperature-Toggle Power-On procedure (see Figure 2-2). When under computer control, an open thermocouple default can be set by the TEMP\_CONFIG command.

#### *Thermocouples*

Thermocouples are formed by joining two wires of dissimilar metals, which produce a voltage proportional to the temperature of the wire junction. The instrument conditions this voltage into temperature measurements. Voltage conditioning includes compensation for the type of thermocouple used and measurement-process compensation that uses a reference temperature sensor built into the Input Module (channels 1 to 20). The front panel terminals (channel 0) cannot be used for thermocouples. The instrument supports nine standard thermocouples, each identified with an American National Standards Institute (ANSI) alpha character (except [ ]): J, [C], B, S, R, N, T, E, or K. A thermocouple type is selected as part of the channel configuration. Table 2-3 summarizes the ranges and characteristics of the supported thermocouples. The instrument displays "otc" when an open thermocouple is detected (as selected with the TEMP\_CONFIG command - see Chapter 4). A type "T" thermocouple is supplied with the instrument.

#### *Resistance-Temperature Detectors*

Resistance-Temperature Detectors (RTDs) are formed from coils or strips of metal, usually platinum, the resistance of which varies with temperature. The instrument conditions this resistance into temperature measurements. The instrument supports any platinum RTD that is calibrated to the IEC 751 Standard ( $a=0.00385$  ohms/ohm/°C). RTDs are characterized by their resistance at 0 °C, which is called the "ice point" or R0. The most common R0 is 100 ohms. The instrument supports any IEC 751 Platinum RTD with an R0 from 000.00 to 999.99, with a default of R0=100.00. Since RTDs are resistance devices, they can be connected to the instrument using one channel (two-terminal connection) or two channels (four-terminal connection). A four-channel configuration provides increased measurement precision. Some RTDs can be purchased in a four-terminal configuration, facilitating a four-terminal connection. The two channels used in a four-terminal connection are a decade apart (n and n+10), for example, channel 3 (n) and 13 (n+10). Only the lower channel is configured.

#### *Thermocouple Restrictions:*

Channel 0. Thermocouple measurements cannot use channel 0.

Open Thermocouple. The instrument displays OTC when an open thermocouple is detected and ignores the channel while scanning.

#### *Resistance Temperature Detectors Restrictions:*

Four-Terminal Channels. Four-Terminal configurations are limited to channels 1 to 10 (n). The channel a decade higher (n + 10) is automatically reserved for use.

Table 2-3. Thermocouple Ranges

Type	Material	Positive Lead (H) Color		Negative Lead Material	Usable Range (°C)
		ANSI*	IEC**		
J	Iron	White	Black	Constantan	-200 to 760
C***	Tungsten (5% Rhenium)	White		Tungsten (26% Rhenium)	0 to 2316
b	Platinum (30% Rhodium)	Gray		Platinum (6% Rhodium)	0 to 1820
S	Platinum	Black	Orange	Platinum (10% Rhodium)	-50 to 1768
R	Platinum	Black	Orange	Platinum (13% Rhodium)	-50 to 1768
N	NICROSIL	Orange		NISIL	-270 to 1300
T	Copper	Blue	Brown	Constantan	-270 to 400
E	Chromel	Purple	Violet	Constantan	-270 to 1000
K	Chromel	Yellow	Green	Alumel	-270 to 1372

\* American National Standards Institute (ANSI) device negative lead (L) is always red.  
 \*\* International Electrotechnical Commission (IEC) device negative lead (L) is always white.  
 \*\*\* Not an ANSI designation but a Hoskins Engineering Company designation.

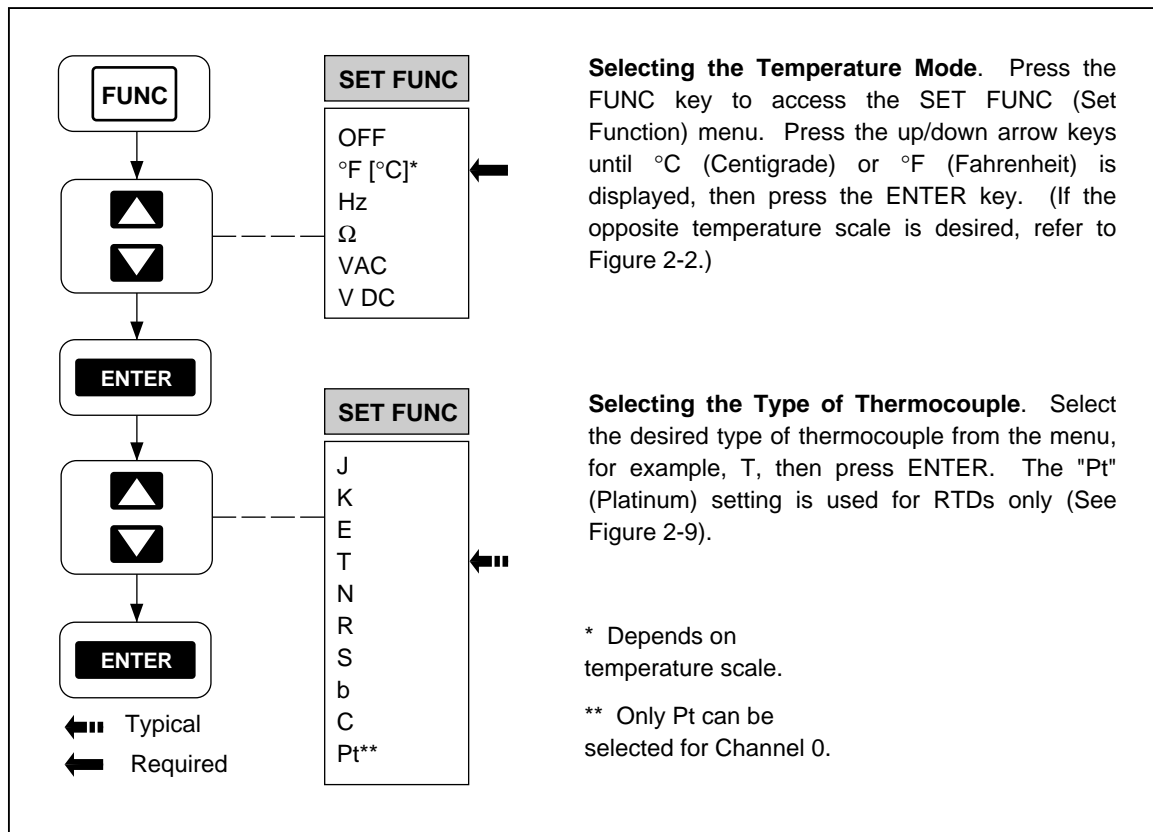

Figure 2-8. Configuring a Channel to Measure Temperature (Thermocouples)

op20f.eps



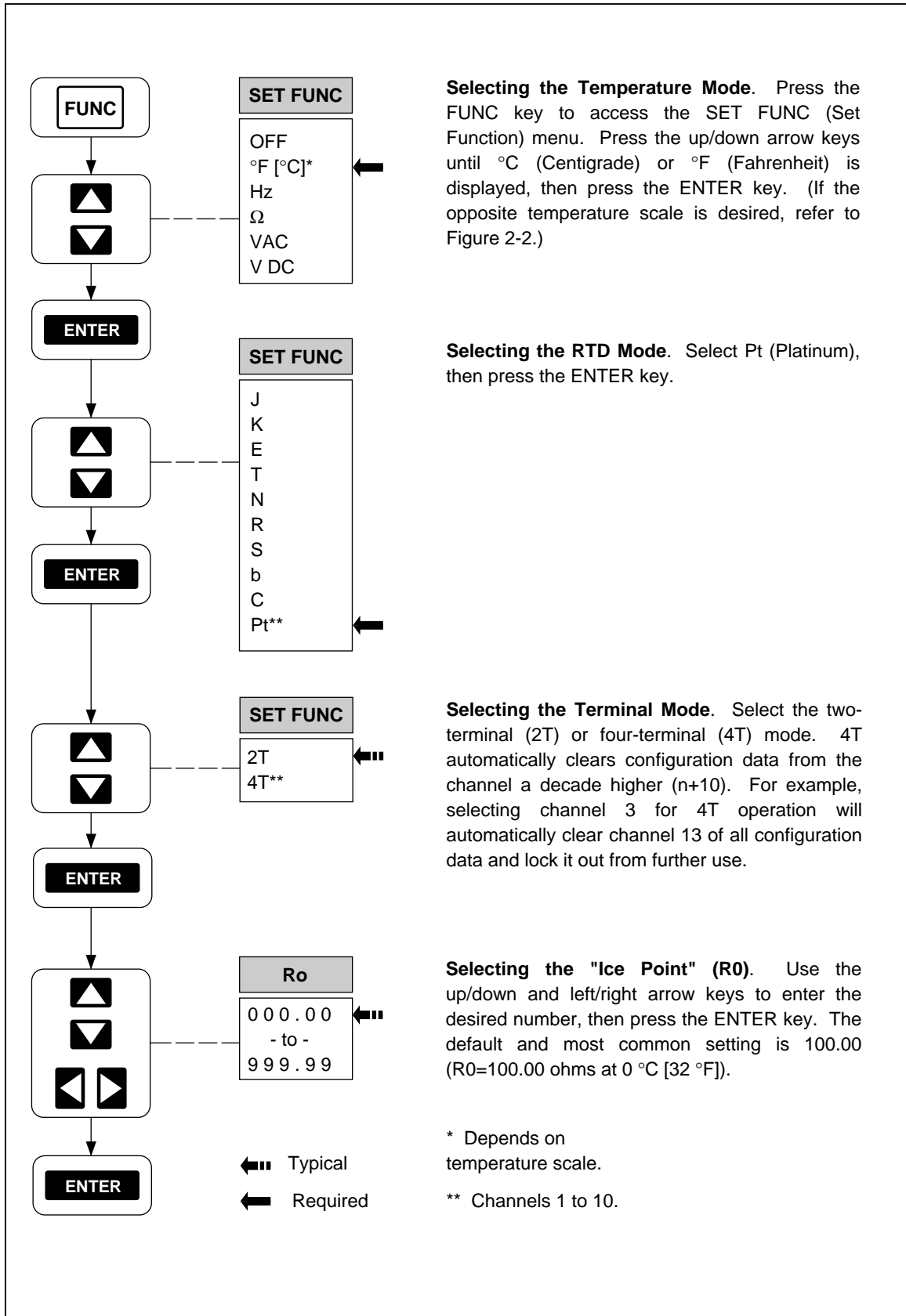

Figure 2-9. Configuring a Channel to Measure Temperature (RTDs)

op21f.eps

### Configuring a Channel Off

Perform the procedure in Figure 2-10 to configure a channel for off (no measurement). In preparation, the instrument must be in the inactive mode (not scanning or monitoring) and the desired channel must be selected (see Figure 2-3). To exit at any time (changes not saved), press the **CANCL** key. When a channel is OFF, it cannot be scanned or monitored. When a channel function is changed, alarm limits and scaling (Mx+B) for that channel are changed to their default conditions.

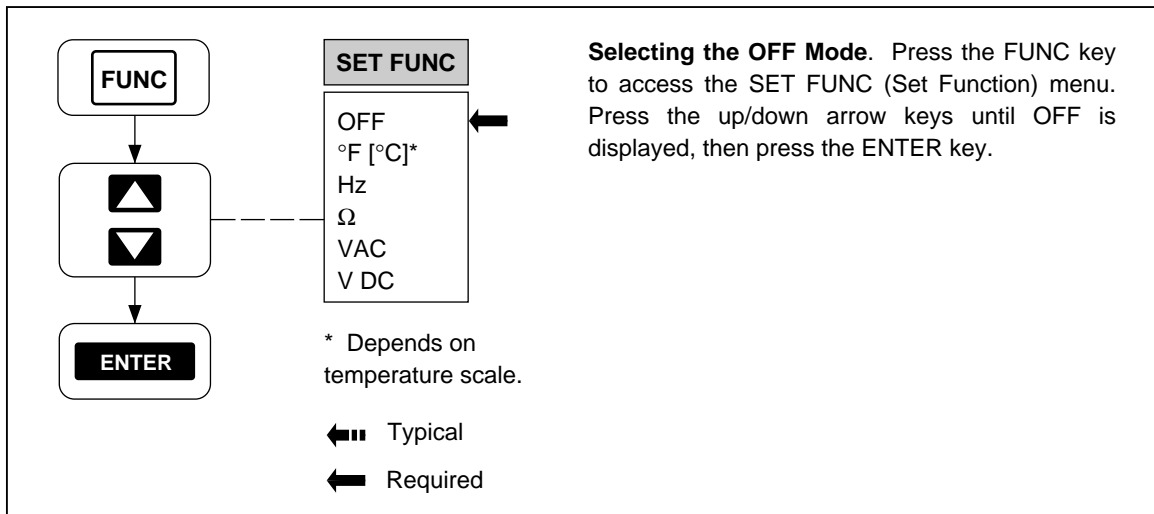

Figure 2-10. Configuring a Channel Off

op22f.eps

### Setting Operating Conditions

After the channels are configured for the desired measurement parameter, set the following operating conditions to support the intended instrument function:

- Setting the Scan Interval [Default - 0:00:00 (Continuous)] (Figure 2-11)
- Setting the Measurement Rate [Default - Slow] (Figure 2-12)
- Setting the Alarms [Default - Alarms off] (Figures 2-13)
- Setting the Mx+B Scaling [Default - 1x+0 (no scaling)] (Figure 2-14)

The instrument default settings for each of the above are shown.

### Setting the Scan Interval

Perform the procedure in Figure 2-11 to set the time between starts of measurement scans. In preparation, the instrument must be in the inactive mode (not scanning or monitoring). To exit at any time (changes not saved), press the **CANCEL** key. The scanning interval format is HOURS:MINUTES:SECONDS. The minimum is 0:00:00 (continuous scanning [default]); the maximum is 9:99:99 (9 hours, 99 minutes, 99 seconds). The scan interval is divided into two portions: the measurement interval when measurements are actually taken, and the time-out interval that completes the overall scan duration. For example, if 10 channels can be measured in 8 seconds, and the scanning interval is set for 30 seconds, the first 8 seconds are used for measurement, while the remaining 22 seconds are used to time out. If the scanning interval is set to less than the measurement rate, the effect is continuous scanning. For example, if 10 channels can be measured in 8 seconds and the scanning interval is set for 5 seconds, scanning is continuous. To speed up the measurement rate, refer to Figure 2-12.

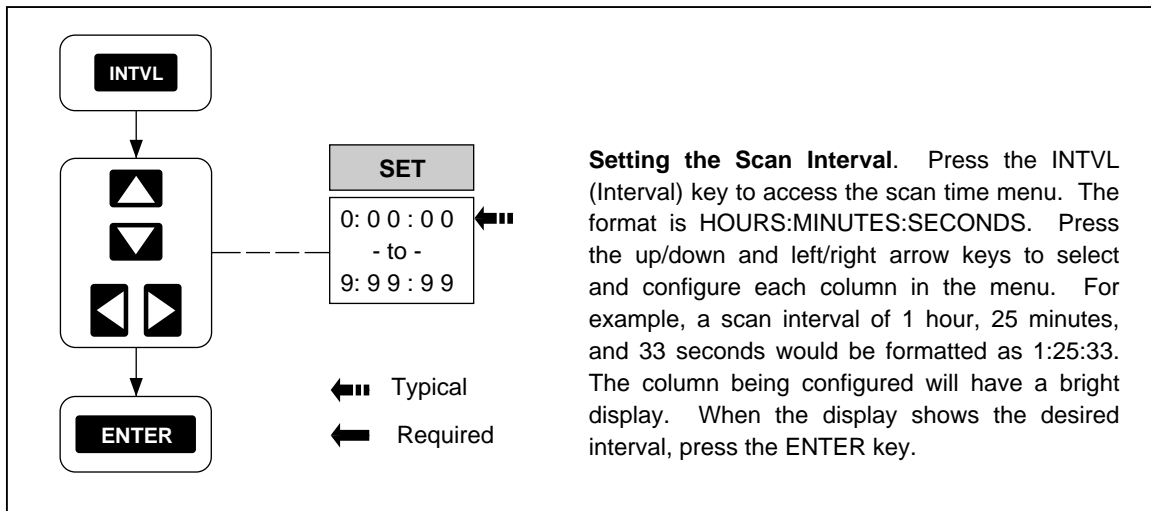

Figure 2-11. Setting the Scan Interval

op23f.eps

### Setting the Measurement Rate

Perform the procedure in Figure 2-12 to set a fast or slow [default] measurement rate. The measurement rate affects the time required to scan the configured channels. However, the fast mode sacrifices one digit of measurement resolution. For example, a temperature reading of 22.4°C in the slow mode would become 22°C in the fast mode, or 27.858V dc in the slow mode would become 27.86 V dc in the fast mode. The fast mode is normally used to capture rapidly changing measurements or to speed up the measurement portion of the scan interval.

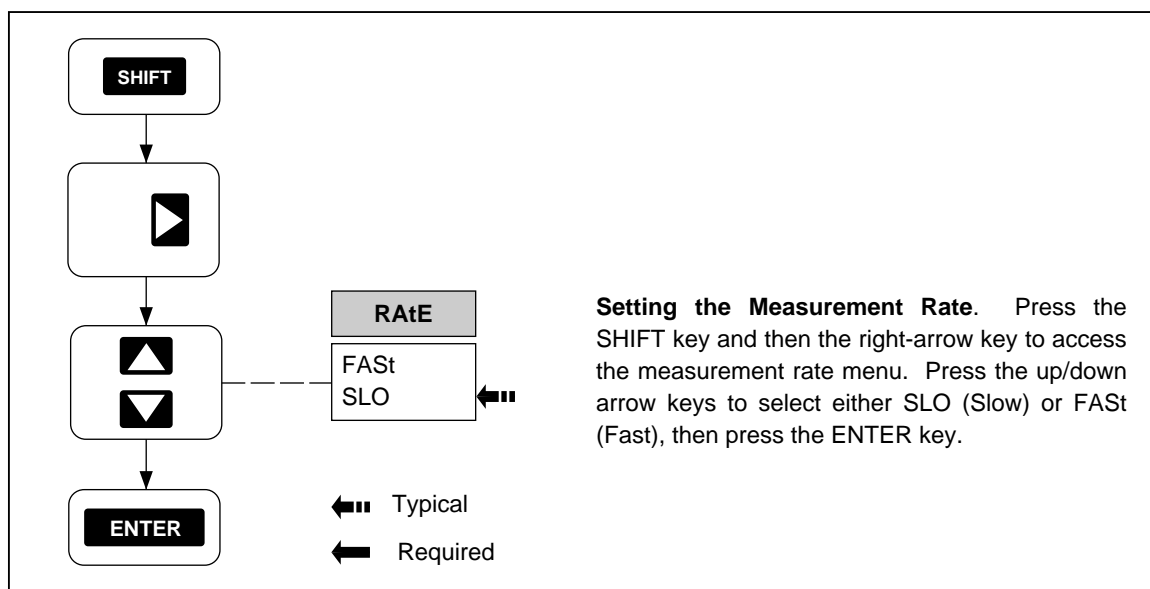

Figure 2-12. Setting the Measurement Rate

op24f.eps

### Setting the Alarms

Perform the procedure in Figure 2-13 to set alarm limits for any configured channel. In preparation, the instrument must be in the inactive mode (not scanning or monitoring) and the desired channel must be configured with a measurement function (see Figures 2-4 to 2-9) and selected (see Figure 2-3). To exit at any time, press the **CANCL** key; however, any alarm parameters previously entered will remain. Two alarm limits, alarm 1 and alarm 2, can be defined for each channel. If applied to a channel with Mx+B scaling, the alarm is based on the scaled values. An alarm occurs when the measured value on the channel moves above the HI (High) or below the LO (Low) value. Alarms can start autoprinting (Figure 5-3), start scanning with the Monitor-Alarm trigger option (Figure 2-19), or trigger other functions via the rear panel digital outputs. In the inactive mode, any selected channel that is programmed with alarm limits will display LIMIT plus 1 and/or 2 to show which alarms have been set. In the different operating modes, the front panel will provide an indication of a channel in an alarm condition. Each is discussed below.

#### Alarm Indications While Scanning

If a scanned channel is in an alarm condition during the scan, the ALARM annunciator is turned on (dim display). If all alarm conditions clear during the next scan, the ALARM annunciator is turned off. See Figure 2-15 for information about the Scan Mode.

### *Alarm Indications While Monitoring*

If the channel being monitored is in an alarm condition, the alarm limit 1 and/or 2 annunciators will be turned on, and the ALARM annunciator blinks bright/dim. The alarm limit annunciator indicates which alarm has been exceeded. If the monitored channel is not in alarm, the ALARM annunciator will be off, unless scanning and some other channel is in alarm, then the ALARM indicator has a steady dim display. See Figure 2-17 for information about the Monitor Mode.

### *Alarm Indications While Reviewing*

If the channel being reviewed had been in an alarm condition, the ALARM and alarm limit 1 and/or 2 annunciators will be turned on. The alarm limit annunciator indicates which alarm has been exceeded. See Figure 2-18 for information about the Review Mode.

### *Clearing Alarm Parameters from a Channel*

To clear alarm parameters from a channel, the alarm can be programmed to OFF for both alarm 1 and alarm 2, or the channel function can be changed to any other selection, including OFF.

### *Alarm Outputs for Channel 0 to 3 Using the Alarm Outputs Connector*

A dedicated transistor-transistor logic (TTL) voltage output is available for channel 0 to channel 3 alarms, via the rear panel ALARM OUTPUTS connector. (See Chapter 1 of this manual for connection information.) If a channel is not in alarm, the voltage output at a connector terminal is a logical high (nominal +5V dc); if a channel is in alarm, the output is a logical low (nominal +0.7V dc). Alarm outputs are set following each scan. As shown in Table 2-4, there are 16 different alarm combinations. The decimal equivalent of the binary half-byte formed by Channel 3 to Channel 0 has significance in autoprinting operations. (See the following discussion on autoprinting.)

### *Alarm Outputs for Channels 4 to 20 Using the Digital I/O Connector*

A shared transistor-transistor logic (TTL) voltage output is available for channel 4 to channel 20 alarms via the rear panel DIGITAL I/O connector, using terminals I/O 7 to I/O 4. (See Chapter 1 of this manual for connection information.) If a channel is not in alarm, the voltage output at a connector terminal is a logical high (nominal +5V dc); if a channel is in alarm, the output is a logical low (nominal +0.7V dc). Alarm outputs are set following each scan. As shown in Table 2-5, the alarm outputs for channels 4 to 20 are ORed in groups. For example, a logical low at I/O 7 indicates that channel 7 or 11 or 15 or 19 is in an alarm condition. Dedicated alarm channels are available only for channels 0 to 3 (see the above). Assigning alarms to channels 4 to 20 does not disable the associated I/O output from use by commands from the computer interface. (See using the "Digital Input/Output Lines" under "Additional Features.") The decimal equivalent of the binary byte formed by I/O 7 to I/O 0 has significance in autoprinting operations (see the following discussion) and for certain commands in the instrument command set, e.g., LOG?.

Table 2-4. TTL Alarm Outputs (Channels 0 to 3)

Channel 3	Channel 2	Channel 1	Channel 0	Decimal
0 (Alarm)	0 (Alarm)	0 (Alarm)	0 (Alarm)	0
0	0	0	1 (No Alarm)	1
0	0	1 (No Alarm)	0	2
0	0	1	1	3
0	1 (No Alarm)	0	0	4
0	1	0	1	5
0	1	1	0	6
0	1	1	1	7
1 (No Alarm)	0	0	0	8
1	0	0	1	9
1	0	1	0	10
1	0	1	1	11
1	1	0	0	12
1	1	0	1	13
1	1	1	0	14
1	1	1	1	15

1 = No Alarm      0 = Alarm

*Note 1. The decimal equivalent of the binary half-byte formed by Channel 3 to Channel 0 is used in autoprint functions.*

*Note 2. The TTL alarm outputs are via the ALARM OUTPUTS rear panel connector.*

### Alarms and Autoprinting

Alarm conditions are indicated for each scanned channel when using the autoprint function, and the ALM (Alarm) and DIO (Digital I/O) conditions are summarized with a decimal number. (See Tables 2-4 and 2-5.) An alarm condition can be used to turn autoprinting on and off by selecting "Print" (printer) or "both" (printer and memory card) as a data destination, and the data mode as ALAr (Alarm) (see Figure 5-3). When scanning using the front panel **SCAN** key, the printer will print measurement results when any scanned channel is in alarm. If scanning using the alarm trigger (see Figure 2-19), the printer will print measurement results only when the monitored channel is in alarm.

### Alarms and Monitor-Alarm Triggering

An alarm condition, coupled with the Monitor Mode, can be used to start and stop measurement scans (see Figure 2-19). When an alarm occurs, scanning begins, and when the alarm clears, scanning stops.

### Alarms and Mx+B Scaling

Alarm settings are affected by Mx+B scaling. The Mx+B scaling determines the value that the instrument displays, and the alarms are configured for these values.

**Table 2-5. TTL Alarm Outputs (Channels 4 to 20)**

Channels	Channels	Channels	Channels	
7 -or- 11 -or- 15 -or-  19	6 -or- 10 -or- 14 -or-  18	5 -or- 9 -or- 13 -or-  17	4 -or- 8 -or- 12 -or-  16 -or- 20 -or-	
I/O 7	I/O 6	I/O 5	I/O 4	Decimal
0 (Alarm) 0 1 (No Alarm) 1 1 1 1	0 (Alarm) 1 (No Alarm) 0 1 1 1 1	0 (Alarm) 1 (No Alarm) 1 0 1 1	0 (Alarm) 1 (Alarm) 1 1 0 1	31 127 191 223 239 255
<p>1 = No Alarm      0 = Alarm</p> <p><i>Note 1. The decimal equivalent of the binary byte formed by Channel 4 to Channel 20 is used in autoprnt and computer functions. The decimal values shown here are based on I/O 3 to I/O 0 being equal to logical 1.</i></p> <p><i>Note 2. The above shows the least complicated Digital I/O alarm configurations. Multiple alarms plus the use of I/O terminals 3 to 0 can conceivably use all 255 digital I/O combinations.</i></p> <p><i>Note 3. The TTL alarm outputs are via the DIGITAL I/O rear-panel connector</i></p> <p><i>Example: A logical 0 at I/O 7 terminals indicates an alarm condition for channel 7, or 11, or 15, or 19. Only channels 0 to 3 have dedicated alarm outputs on the ALARM OUTPUTS connector.</i></p>				

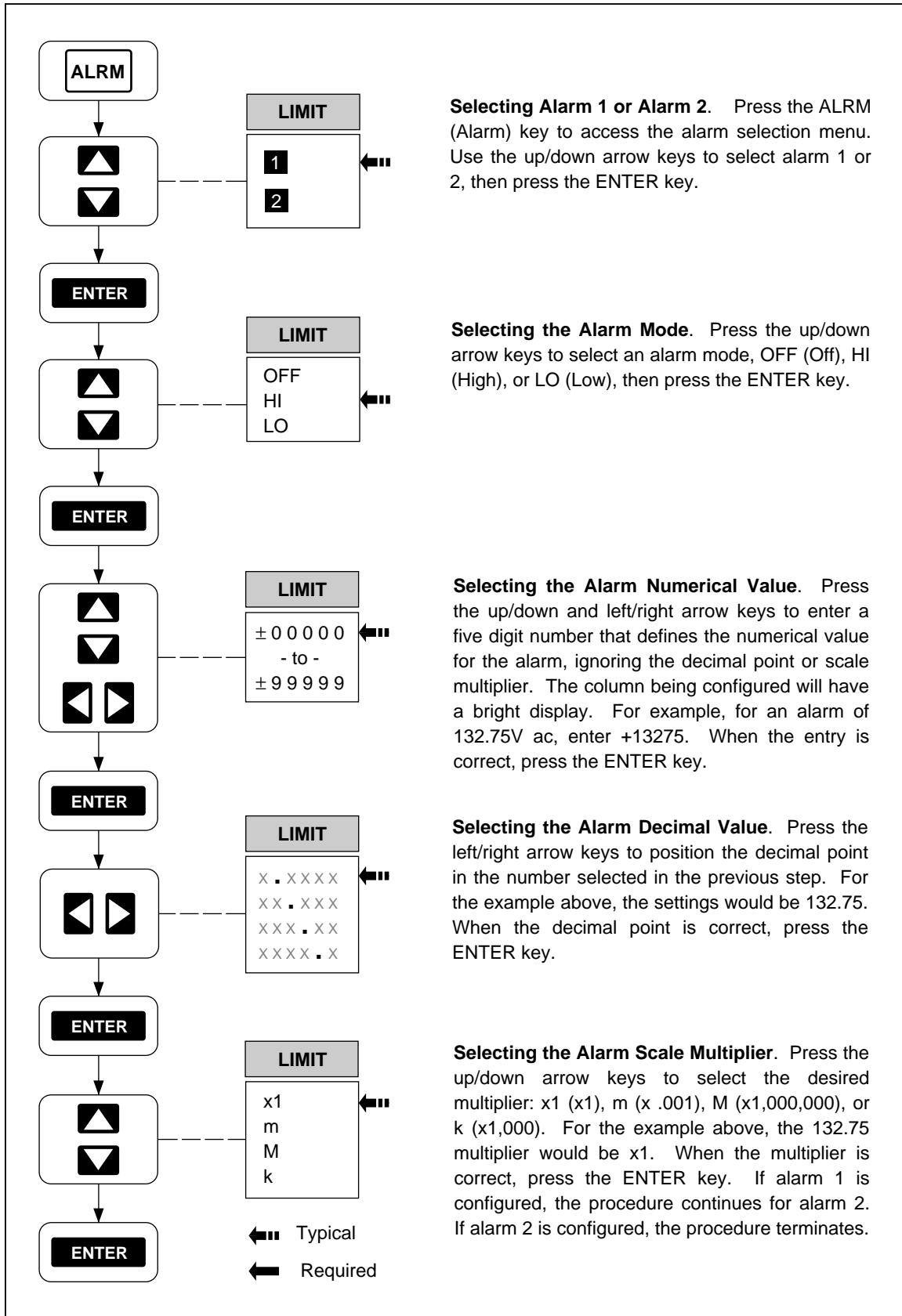

Figure 2-13. Setting the Alarms

op25f.eps



### **Setting the Mx+B Scaling**

Perform the procedure in Figure 2-14 to set the Mx+B scaling for any configured channel. In preparation, the instrument must be in the inactive mode (not scanning or monitoring) and the desired channel must be configured with a measurement function (see Figures 2-4 to 2-9) and selected (see Figure 2-3). To exit at any time, press the **CANCEL** key; however, any Mx+B parameters previously entered will remain. Scaling allows a measurement value (x) to be modified with a fixed multiplier (M) and a fixed offset (B). A channel with scaling other than the default of 1x+0 will display Mx+B when the channel is selected. When scaling is used, only a number is displayed; function identifiers such as °C, Hz, Ω, VAC, and VDC are removed. If the results from Mx+B scaling are nonsense, double check the signs and multiplier values for M and B.

### **Examples**

**Multiplier.** If a pressure transducer provides 100 mV for 100 PSI, 200mV dc for 200 PSI, etc., the instrument would read directly in PSI with a multiplier of 1000, or M=+1k and B=000.00. For example, a PSI of 156.98 would display the number 156.98.

**Offset.** If you are monitoring line voltage of 115V ac and you want the instrument to display the variations above and below 115V ac instead of the actual voltage, the instrument would display the differences by subtracting -115 from the measurements, or B=-115.00 (M=1.0). For example, 117.21V ac would display only the number 2.21; 113.45V ac would display the number -1.55.

**Multiplier and Offset.** If the instrument is measuring temperature using the °F scale, but you want it to display the measurements in °C, the conversion formula  $^{\circ}\text{C} = 5/9(^{\circ}\text{F} - 32)$ , rewritten in decimal  $^{\circ}\text{C} = .55555^{\circ}\text{F} - 17.777$ , could make the conversion with M=+.55555 (entered as +555.55m) and B=-017.78. For example, 72.2 °F would display the number 22.28.

### **Restrictions**

**Linearity.** The transfer characteristic of the transducers or measurement modifications must be linear, with fixed multipliers (M) and fixed offsets (B).

**Overload (OL) Display.** The decimal point location and scaling (m, X1, k, M) selected for the "B" value determines the scaling for the result. For example, if B=xxx.xx x1, the result will range over ±999.99 only. Anything greater than +999.99 or less than -999.99 will show "OL" (overload).

### **Clearing Mx+B Scaling from a Channel**

To clear Mx+B parameters from a channel, the Mx+B parameters can be programmed to 1x+0 (M=1, B=0), or the channel function can be changed to any other selection, including OFF.

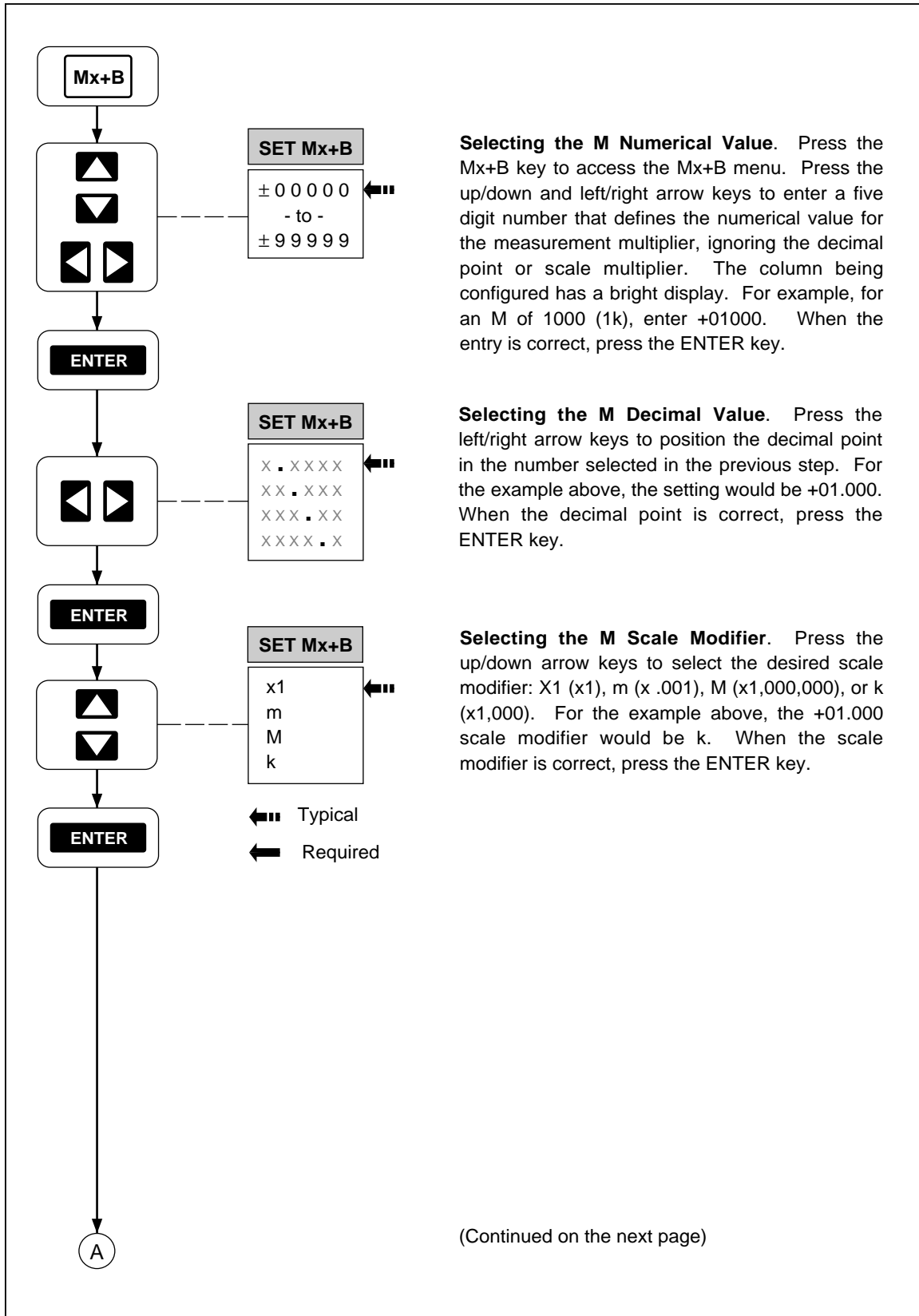

**Selecting the M Numerical Value.** Press the Mx+B key to access the Mx+B menu. Press the up/down and left/right arrow keys to enter a five digit number that defines the numerical value for the measurement multiplier, ignoring the decimal point or scale multiplier. The column being configured has a bright display. For example, for an M of 1000 (1k), enter +01000. When the entry is correct, press the ENTER key.

**Selecting the M Decimal Value.** Press the left/right arrow keys to position the decimal point in the number selected in the previous step. For the example above, the setting would be +01.000. When the decimal point is correct, press the ENTER key.

**Selecting the M Scale Modifier.** Press the up/down arrow keys to select the desired scale modifier: X1 (x1), m (x .001), M (x1,000,000), or k (x1,000). For the example above, the +01.000 scale modifier would be k. When the scale modifier is correct, press the ENTER key.

(Continued on the next page)

op26f.eps

Figure 2-14. Setting the Mx+B Scaling

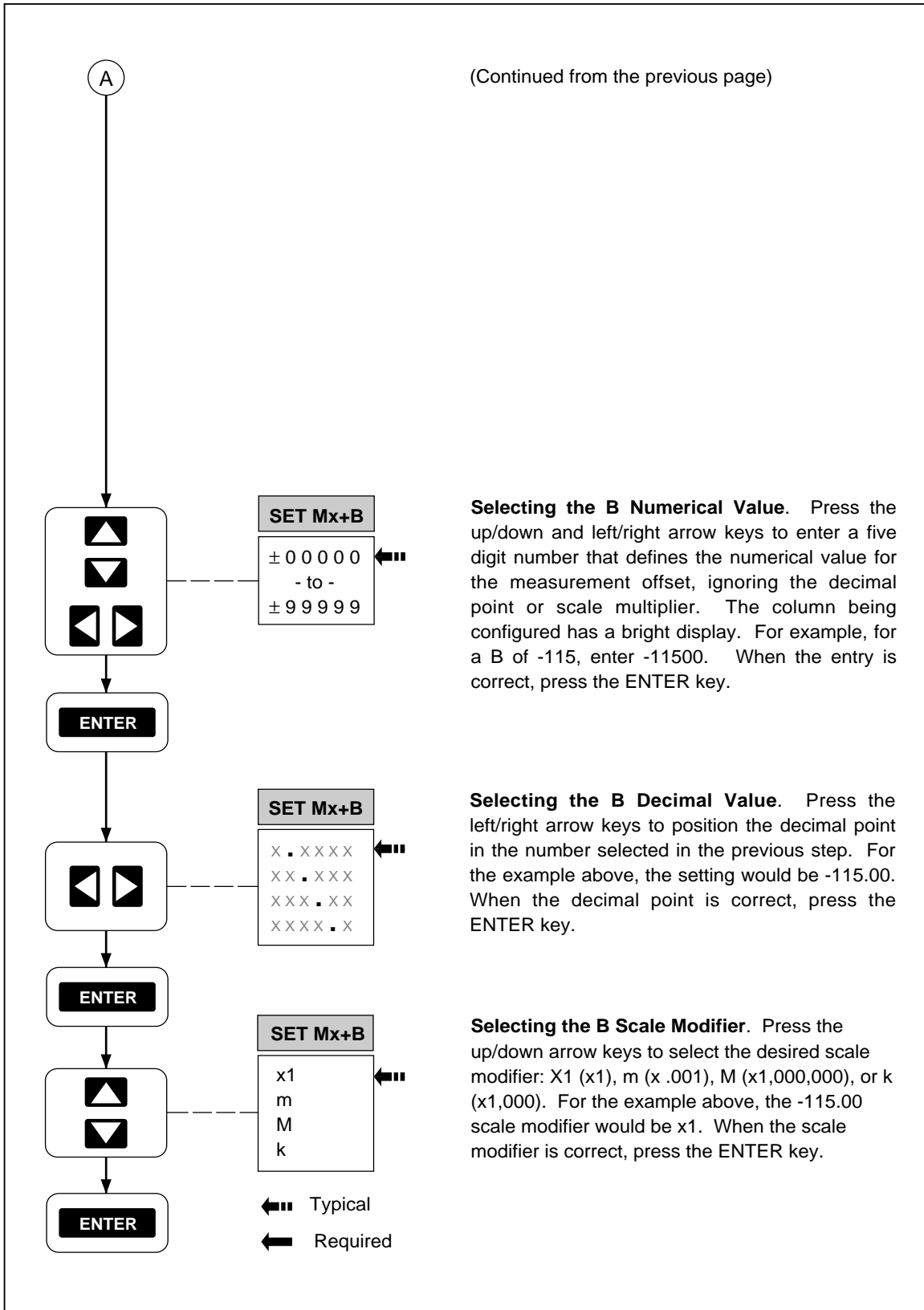

Figure 2-14. Setting the Mx+B Scaling (cont)

op26af.eps

## Operating Modes

With the channels configured and operating conditions set, the instrument is ready for operation in one of the following modes:

- Using the Scan Mode (Figure 2-15)
- Using the Monitor Mode (Figure 2-17)
- Using the Review Mode (Figure 2-18)

Each operating mode is discussed below. To modify the operating mode with additional features, such as using the scan triggering, refer to the next main headings in this chapter, "Additional Features."

### Using the Scan Mode

Perform the procedure in Figure 2-15 to start and stop the Scan Mode of operation. The Scan Mode can be started when the instrument is inactive, in Monitor (Figure 2-17), or Review (Figure 2-18). Measurement results can be sent to a memory card (see Chapter 3, "Memory Card Operations") and PC (see Chapter 4, "Computer Operations") or printer (see Chapter 5, "Printer Operations"). When using the Scan Mode with a memory card, consider each of the following topics. (Memory card error messages are summarized in Figure 2-16.)

#### Memory Card as a Data Destination

Measurement data is not automatically sent to the memory card. Measurement data can be sent to a printer/PC, to the memory card, to both printer/PC and memory card, or to neither. If either the printer/PC or memory card, or both are selected, the PRN annunciator will be on. See Figure 3-4 to set the destination and mode for sending measurement data to the memory card.

#### Memory Card Formatting

When the instrument is inactive (not scanning or monitoring), insert a memory card. An immediate error Err 1/CARD indicates the memory card is not initialized (formatted). See Figure 3-3 to initialize a memory card.

#### Memory Card Capacity

A memory card that fills during scanning displays the error Err 3/FULL, meaning readings are being saved in internal memory (75 scans maximum) and another card should be inserted. The error changes to Err 4/FULL if the internal memory fills, saving only the most recent 75 scans. When inserted, the replacement card is updated with the scans in memory.

#### Memory Card Files

Data files (dAtxx) are opened manually (see Figure 3-8) or prompted by pressing **SCAN**. Press **ENTER** to accept file names or use the up/down and left/right arrow keys to select a file name and then press **ENTER**. If a data file cannot be opened, error Err 2/FILE will be displayed, meaning all files dAt00 to dAt99 already exist or the selected file name is already assigned.

#### Memory Card Exchange During Scanning

Eject the active card when the BUSY indicator is off and replace with another card. The instrument opens the same file name on the new card. If this file cannot be opened, Err

3/bAd is displayed (see Figure 2-16). Err4/bAd indicates the internal memory is full, saving only the most recent 75 scans. The new card is updated with the scans in memory.

### Memory Card Data Extraction

Measurement data recorded onto a memory card can be read only by a PC running Starter or Logger applications software. If you want to have a copy of the measurement data when it is being recorded, connect a printer during scan operations (see Chapter 5, Printer Operation). If using a printer, verify the data destination is "both" (memory card/printer) (see Figure 5-3).

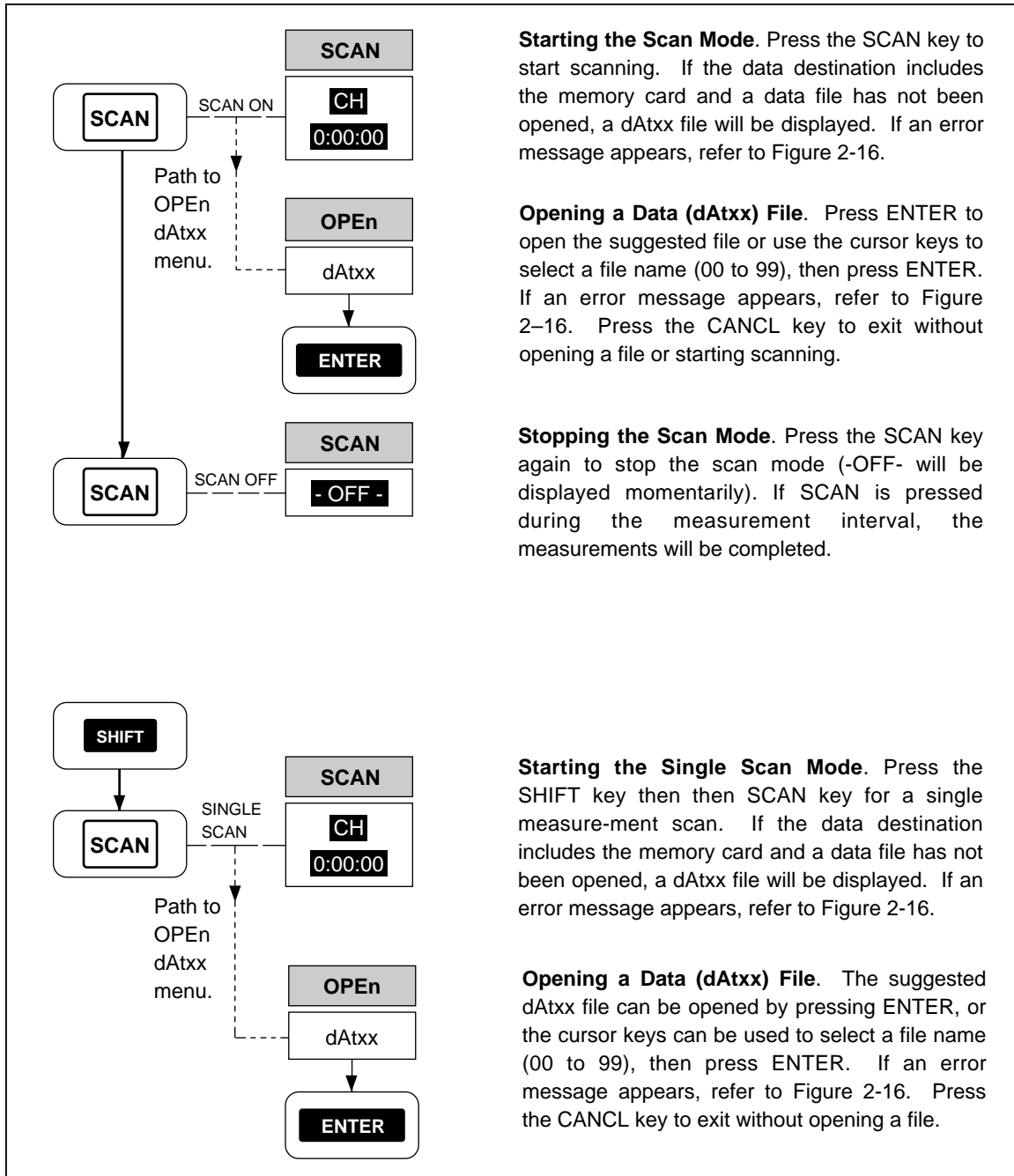

**Starting the Scan Mode.** Press the SCAN key to start scanning. If the data destination includes the memory card and a data file has not been opened, a dAtxx file will be displayed. If an error message appears, refer to Figure 2-16.

**Opening a Data (dAtxx) File.** Press ENTER to open the suggested file or use the cursor keys to select a file name (00 to 99), then press ENTER. If an error message appears, refer to Figure 2-16. Press the CANCL key to exit without opening a file or starting scanning.

**Stopping the Scan Mode.** Press the SCAN key again to stop the scan mode (-OFF- will be displayed momentarily). If SCAN is pressed during the measurement interval, the measurements will be completed.

**Starting the Single Scan Mode.** Press the SHIFT key then then SCAN key for a single measurement scan. If the data destination includes the memory card and a data file has not been opened, a dAtxx file will be displayed. If an error message appears, refer to Figure 2-16.

**Opening a Data (dAtxx) File.** The suggested dAtxx file can be opened by pressing ENTER, or the cursor keys can be used to select a file name (00 to 99), then press ENTER. If an error message appears, refer to Figure 2-16. Press the CANCL key to exit without opening a file.

Figure 2-15. Using the Scan Mode

op27f.eps

### Memory Card Error Messages

Any illegal memory card operation results in a double "beep" and an error display as shown in Figure 2-16. If the instrument is scanning and in the Monitor Mode or Review Mode, only the double beep will be heard for a memory card error. Error messages are acknowledged by pressing the **ENTER** key or by ejecting the memory card.

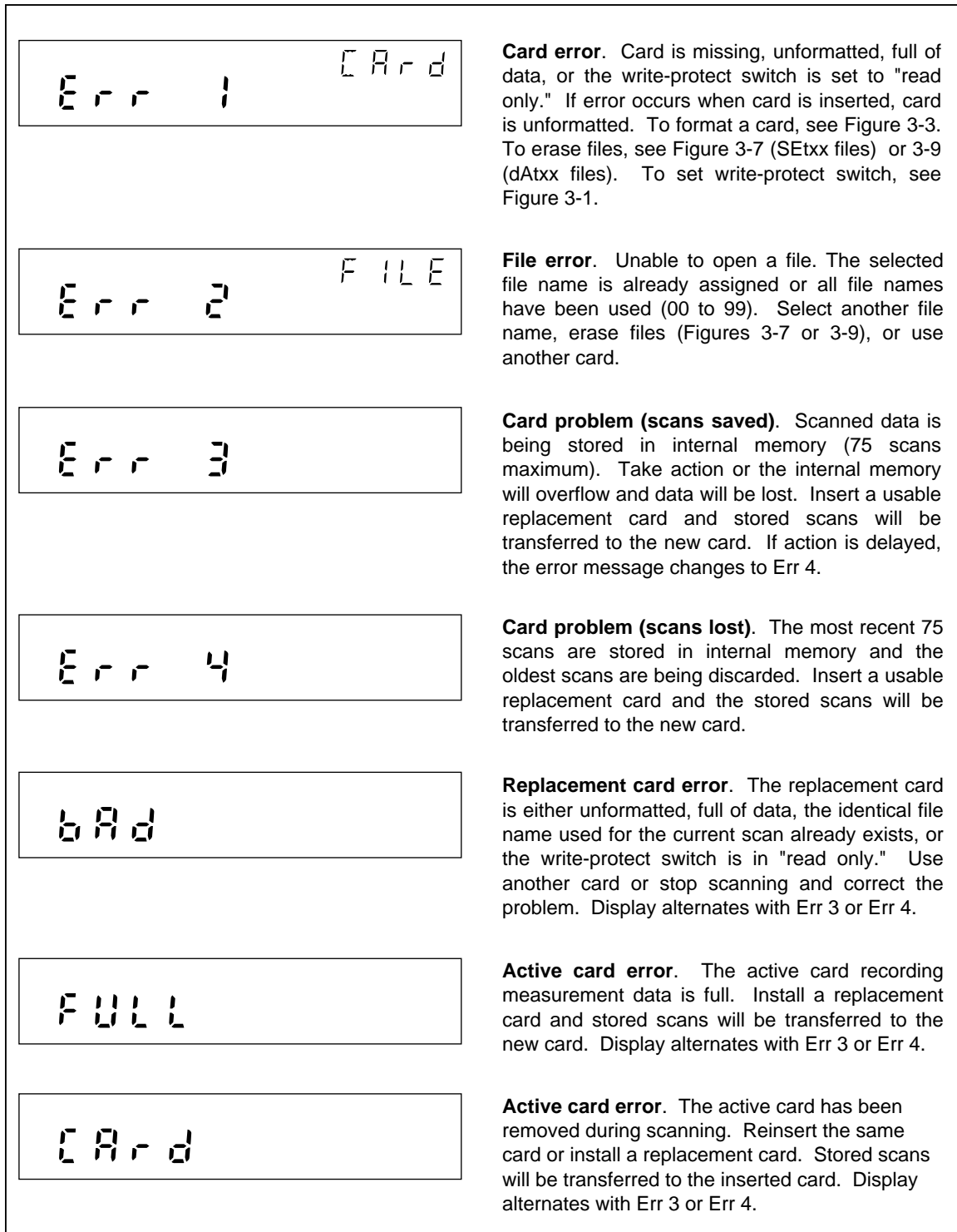
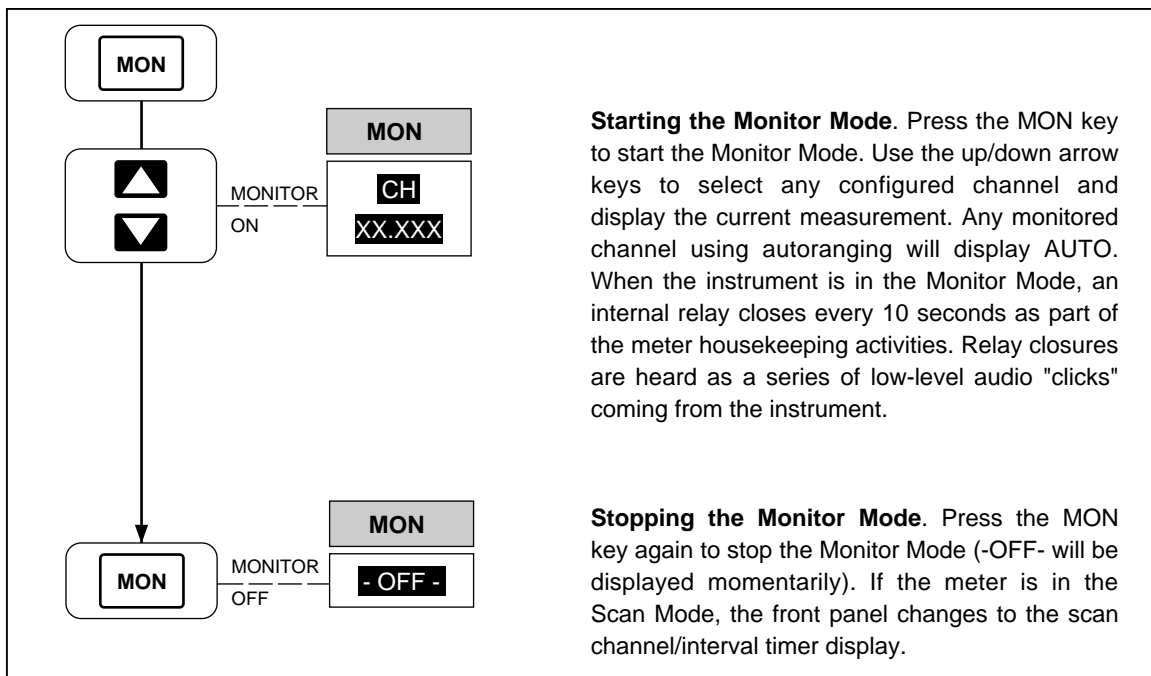

Figure 2-16. Memory Card Error Messages

op28f.eps

### Using the Monitor Mode

Perform the procedure in Figure 2-17 to start and stop the Monitor Mode of operation. The Monitor Mode can be started when the instrument is in the inactive mode or in the Scan Mode. The Monitor Mode commands the instrument to display the present measurement for any selected channel (except channels set to OFF) and to display alarm information if the channel is in alarm. If the Monitor Mode is used without the Scan Mode, the instrument operates like a multimeter. If the Monitor Mode is used with the Scan Mode, the instrument also operates like a multimeter but measurements can be recorded into memory, printed out, and reviewed (maximum, minimum, last values). The Monitor-Alarm triggering option uses the Monitor Mode to start or stop scans when a selected channel goes into or out of alarm (see Figure 2-19). If the instrument is in the Monitor Mode and scanning using the memory card, any illegal memory card operations are noted only with a double "beep." When you hear a double beep, exit the Monitor Mode and investigate the memory card error (see Figure 2-16).



op29f.eps

Figure 2-17. Using the Monitor Mode

### Using the Review Mode

Perform the procedure in Figure 2-18 to operate the Review Mode of operation. The Review Mode is used any time during or after operation of the Scan Mode. While the instrument is in the Scan Mode, the last, maximum, and minimum measurements for each scanned channel are stored in memory and updated with each scan, forming the Review Array. For example, during scan operations, **REVIEW** can be used to monitor the maximum measurement of a channel in real time. The Review Array is cleared by a control sequence (see Figure 2-18 below), or by changing any parameter of any channel or the measurement rate. The Review Array can be printed out using the **LIST** key (see Figure 5-4). If the instrument is in the Review Mode and scanning using the memory card, any illegal memory card operations is noted only with a double "beep." If a double beep is heard, exit the Review Mode and check the memory card error (see Figure 2-16).

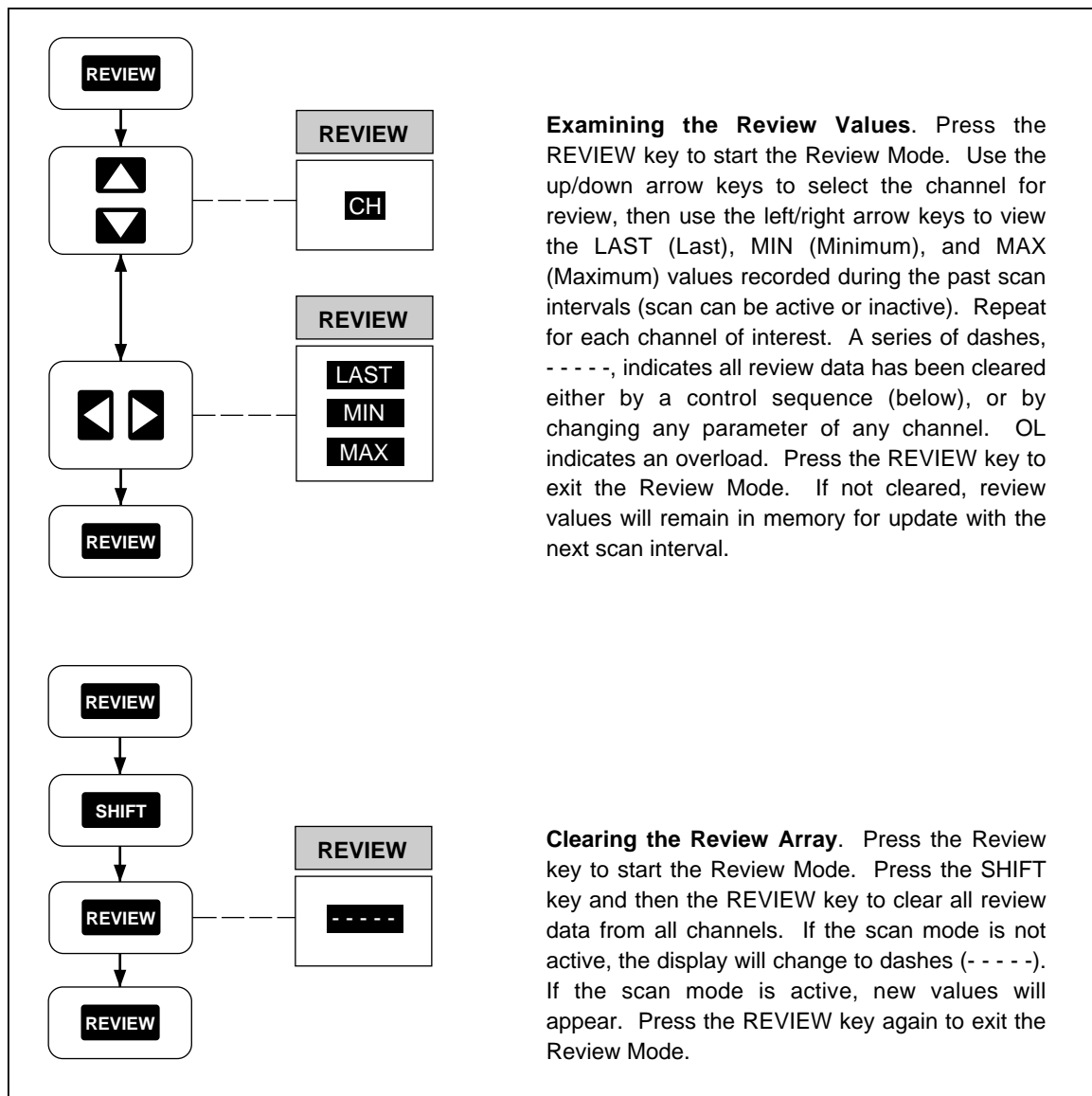

Figure 2-18. Using the Review Mode

op30f.eps



## **Additional Features**

The following additional features allow the instrument to serve in a variety of applications:

- Scan Triggering Options (Figure 2-19)
- Totalizer Operation (Figure 2-20)
- Digital Input/Output Lines
- Setting Date and Time (Figure 2-21)
- Reading Instrument Software Versions (Figure 2-22)
- Returning to the LOCAL Mode (Figure 2-23)
- Front Panel Key Lockout Option (Figure 2-24)

### **Scan Triggering Options**

Perform the procedure in Figure 2-19 to select a triggering option, which can be applied when the instrument is in the inactive mode (not scanning or monitoring). Normally, a scan is started by pressing the **SCAN** key, but two options can be selected to start a scan from either an external trigger input or from a monitor-alarm condition. The **SCAN** key overrides a triggering option.

#### *External Trigger*

The external trigger input starts a scan from a contact closure or TTL input applied to the TR and GROUND inputs on the rear panel ALARM OUTPUTS connector (see Figure 1-7). This option lights the EXT TR annunciator.

#### *Monitor-Alarm Trigger*

The Monitor-Alarm trigger starts scanning from a channel that goes into an alarm while being monitored in the Monitor Mode. When the monitored channel goes into alarm, the instrument scans for as long as the alarm condition exists. This option lights the TR annunciator.

#### *Triggering Options and Memory Card Operation*

To verify the equipment setup when the memory card is used to record data, use the Single Scan mode (see Figure 2-15) to record a single scan. Any problems with the memory card or setup can be observed and corrected. If a triggering option triggers scanning without an open memory card dAtxx file, the instrument will automatically open a file when a usable memory card is in the instrument. If no memory card is installed or the memory card is not usable, the most recent 75 scans are saved in an internal memory. To record the saved scans, insert a usable memory card and open a file (see Figure 3-8). The stored scans will be transferred to the card.

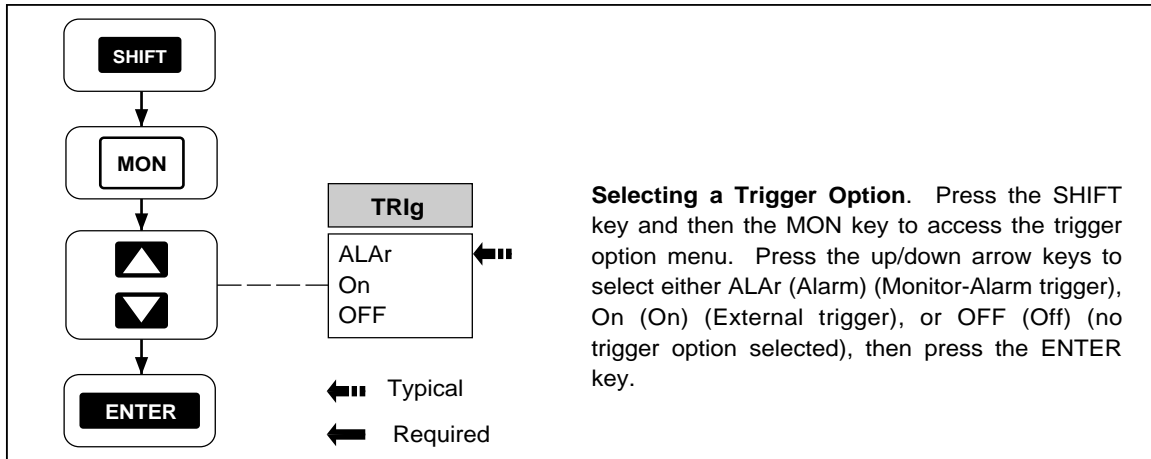

op31f.eps

Figure 2-19. Scan Triggering Options

### Totalizer Operation

Perform the procedure in Figure 2-20 to use the totalizer feature. The totalizer count can be monitored when the instrument is active or inactive. The totalizer is an internal counter that sums contact closures or voltage transitions. Connection is at the rear panel DIGITAL I/O connector, pins SUM and GROUND. A contact closure between SUM and GROUND or a voltage transition applied to SUM (referenced to GROUND), will cause the totalizer to advance by one count. The maximum count allowed is 65535 and the maximum count rate is 5 kHz. Voltages trigger on a low-to-high transition at a nominal threshold of +1.4 volts. A contact debounce feature is available when the instrument is operated through a computer interface. (See Chapter 4, "Computer Operations.")

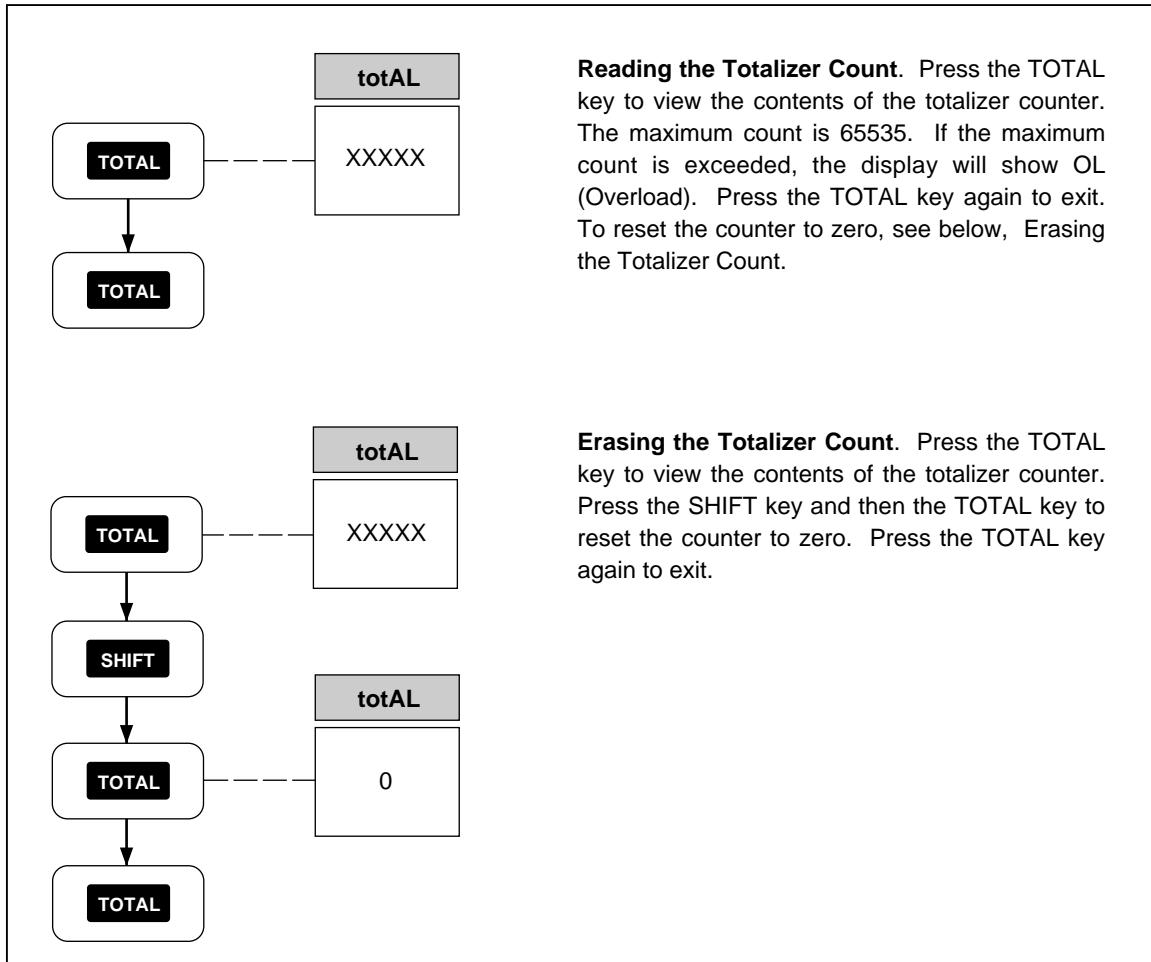

Figure 2-20. Totalizer Operation

op32f.eps

### Digital Input/output Lines

There are no front panel controls or annunciators for the digital input/output (I/O) lines, I/O 7 to I/O 0. Connection to the eight I/O lines is via the rear panel DIGITAL I/O connector. If a logic low is applied to any line, the instrument treats it as an input; if the instrument sets a line to logic low, the instrument treats it as an output. An output low condition takes precedence over an input high condition. All digital I/O lines are controlled by a computer interface (see Chapter 4, "Computer Operations"); however, as a default, lines I/O 7 to I/O 4 are used to output alarm status conditions for channels 4 to 20 (see Table 2-5). An instrument-generated I/O line alarm output takes precedence over any other configuration.

All Digital I/O lines are set high (non-active) whenever power is cycled. These lines remain high until an alarm condition or computer interface command changes an output state.

*Note*

*Measurements taken with the Monitor function do not affect the digital outputs.*

### Setting Date and Time

Perform the procedure in Figure 2-21 to set the instrument internal clock and calendar, which must be correct since measurements are tagged with this time and date. The built-in clock accuracy is a nominal one minute per month. Once set to the correct date and time, clock and calendar operation is automatic and no further action is required.

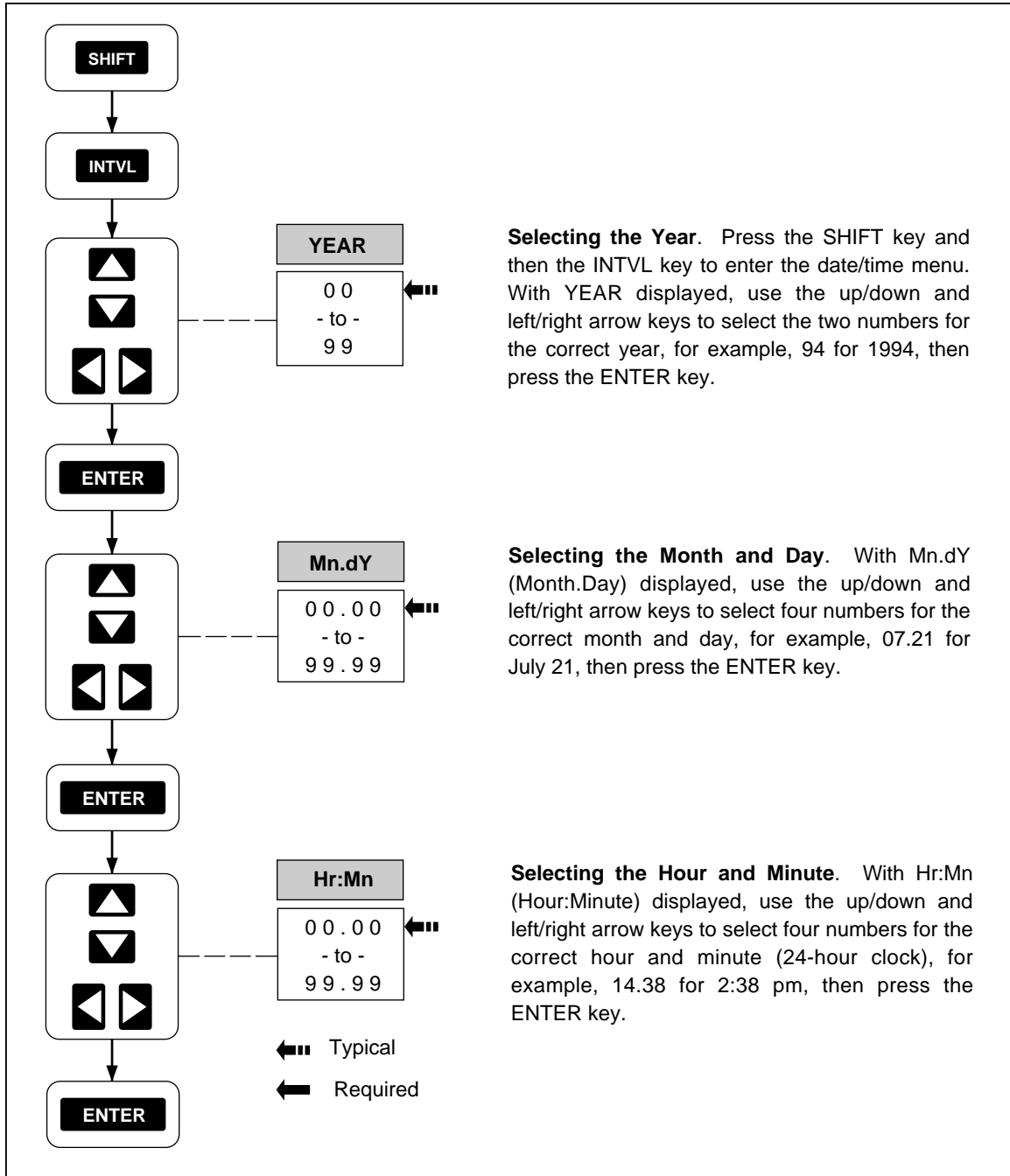
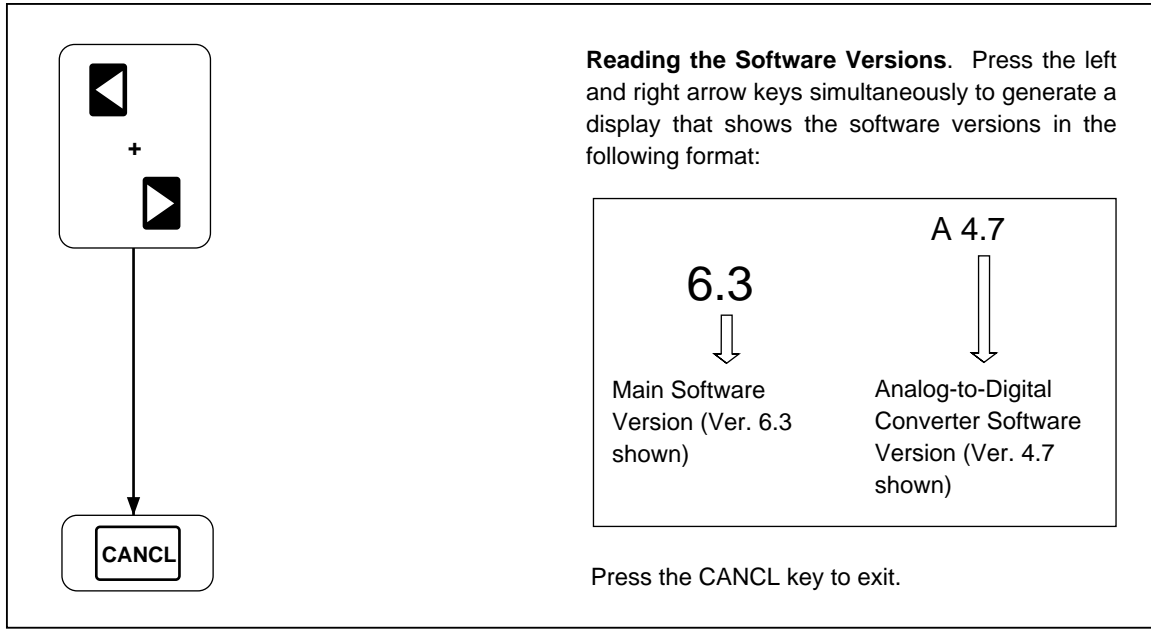

Figure 2-21. Setting Date and Time

op33f.eps

### Reading Instrument Software Versions

Perform the procedure in Figure 2-22 to view the version of the internal software that is controlling the instrument's operation. Two software versions are identified with this procedure: the main software that operates all instrument functions, and the analog-to-digital software that operates the instrument analog-to-digital converter.



op34f.eps

Figure 2-22. Reading Instrument Software Versions

### Returning to the Local Mode

Perform the procedure in Figure 2-23 to return the instrument from the remote mode to the local mode. When the instrument is operated over the RS-232 computer interface, the computer can disable all front panel controls except the **SCAN** key, which lights the REM annunciator (bright). If the REM annunciator is dim, the front panel keys are locked out (see Figure 2-24).

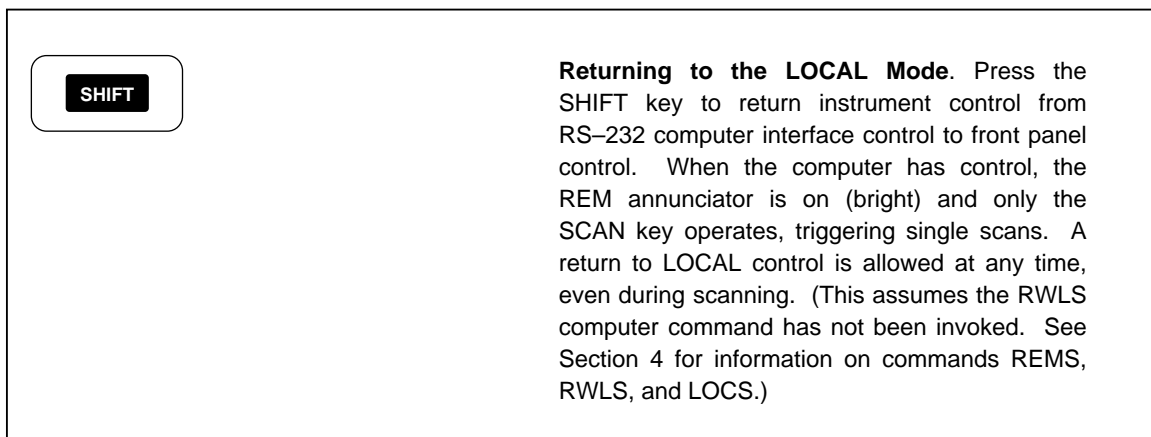

op35f.eps

Figure 2-23. Returning to LOCAL Mode

### Front Panel Key Lockout Options

Perform the procedure in Figure 2-24 to lockout the front panel key functions. There are three lockout features:

- Monitor Mode Lockout
- Review Mode Lockout

A third lockout can be enabled only from the computer interface (see the LOCK 3 command in Chapter 4).

The Monitor Mode lockout is entered when the instrument is in the Monitor Mode; the Review Mode Lockout is entered when the instrument is in the Review Mode. When lockout is enabled, the instrument becomes "locked" in a selected mode preventing any unauthorized instrument operations. A repeat of the lockout keystrokes releases the lockout and the instrument resumes normal operation. When in the locked condition, the front panel REM indicator is on (dim). This feature allows inexperienced operators to use the instrument without having to change the mode of operation. The keystrokes used to enable or disable the lockout option is normally not revealed to unauthorized personnel.

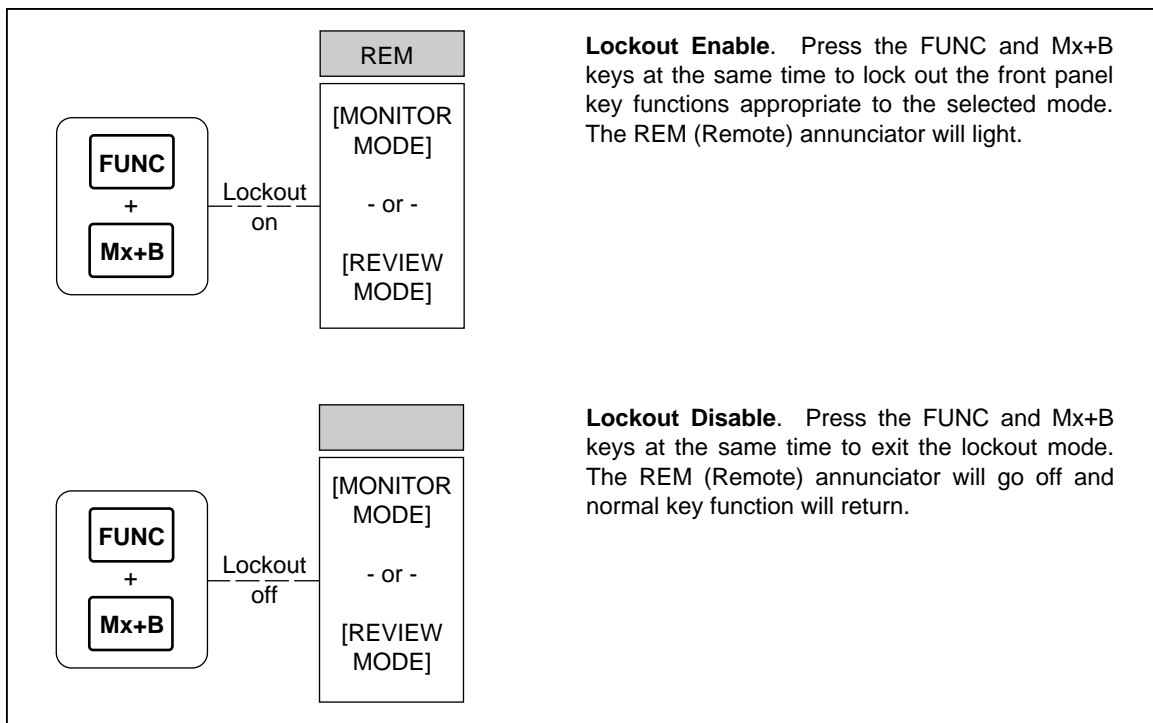

Figure 2-24. Front Panel Key Lockout Options

op36f.eps

### Instrument Interfaces

Front panel operations that involve interfacing with memory cards, PCs, printers, and modems are described in separate manual chapters, as follows.

#### Memory Card Interface

The Memory Card Interface is described in detail in Chapter 3, "Memory Card Operations."

***RS-232 Computer Interface***

The Computer Interface is described in detail in Chapter 4, "Computer Operations."

***Using the RS-232 Computer Interface With a Printer***

The Printer Interface is described in detail in Chapter 5, "Printer Operations."

***Using the RS-232 Computer Interface With a Modem***

The Modem Interface is described in detail in Chapter 6, "Modem Operations."





## **Chapter 3**

# **Memory Card Operations**

<b>Title</b>	<b>Page</b>
Summary of Memory Card Operations .....	3-3
Memory Card Files .....	3-3
Setup Files.....	3-4
Data Files .....	3-4
Memory Card Capacity .....	3-4
Memory Card Battery .....	3-5
Inserting and Removing the Memory Card .....	3-5
Inserting a Memory Card .....	3-5
Removing a Memory Card.....	3-5
Changing the Memory Card During Scanning.....	3-5
Setting the Memory Card Write-protect Feature .....	3-5
Installing or Replacing the Memory Card Battery .....	3-5
Initializing a Memory Card .....	3-7
Recording Measurement Results During Scanning.....	3-8
Setup File Procedures.....	3-9
Using Setup Store.....	3-9
Using Setup Load.....	3-10
Using Setup Erase .....	3-11
Data File Procedures .....	3-12
Using Data Open .....	3-12
Using Data Erase.....	3-13
Setup and Data Files Directory .....	3-14
Setup and Data File Current Status .....	3-15
Memory Card File Operations to and from a PC .....	3-16

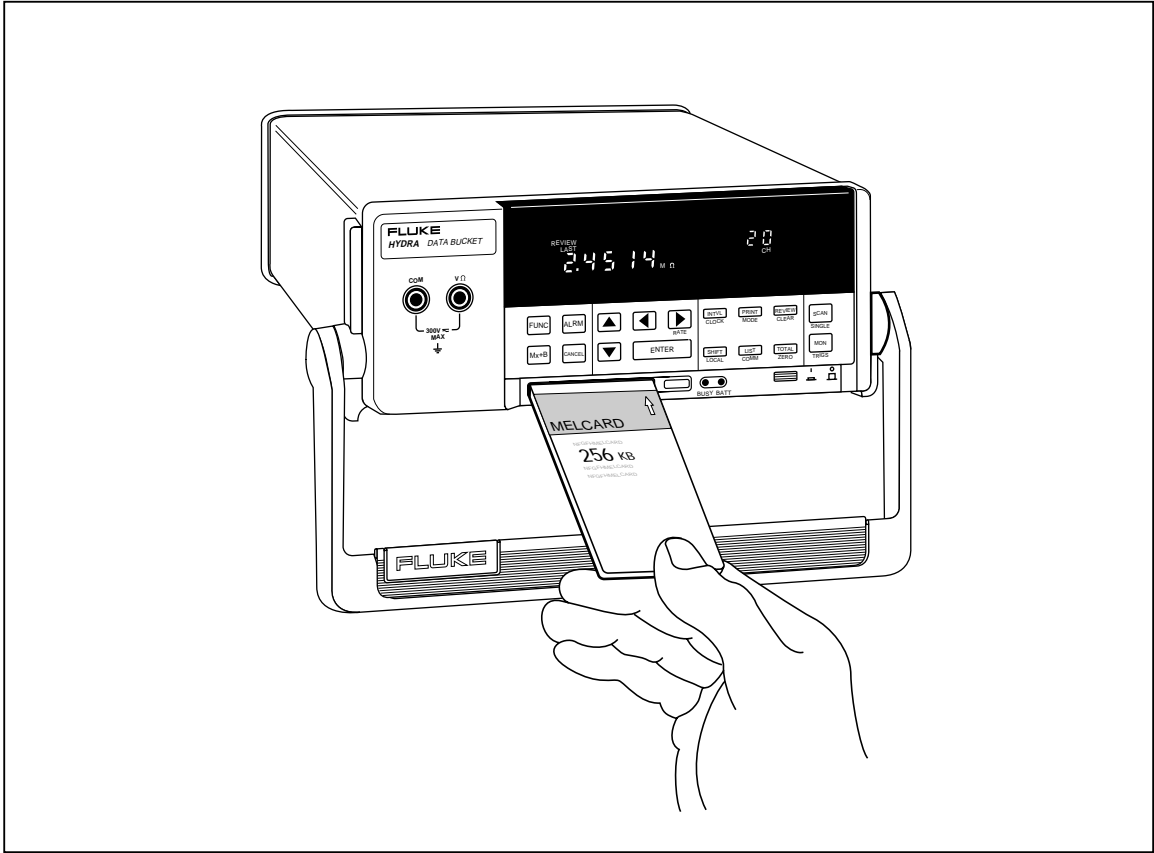

op81f.eps

## Summary of Memory Card Operations

Memory card operations use a small, lightweight memory card (Figure 3-1) to save and load setup files (instrument configurations) and to record measurement data during scanning. The memory card consists of static random-access memory (SRAM) powered by an internal battery. Care should be taken not to drop or bend the card, and to keep it dry and away from high and low temperature extremes. Memory card operation is allowed in the same temperatures and humidity specifications that apply to the instrument (see Appendix A, "Specifications"). SRAM memory cards are readily available from supply houses serving the computer industry, or from Fluke (see Table 1-2, "Options and Accessories").

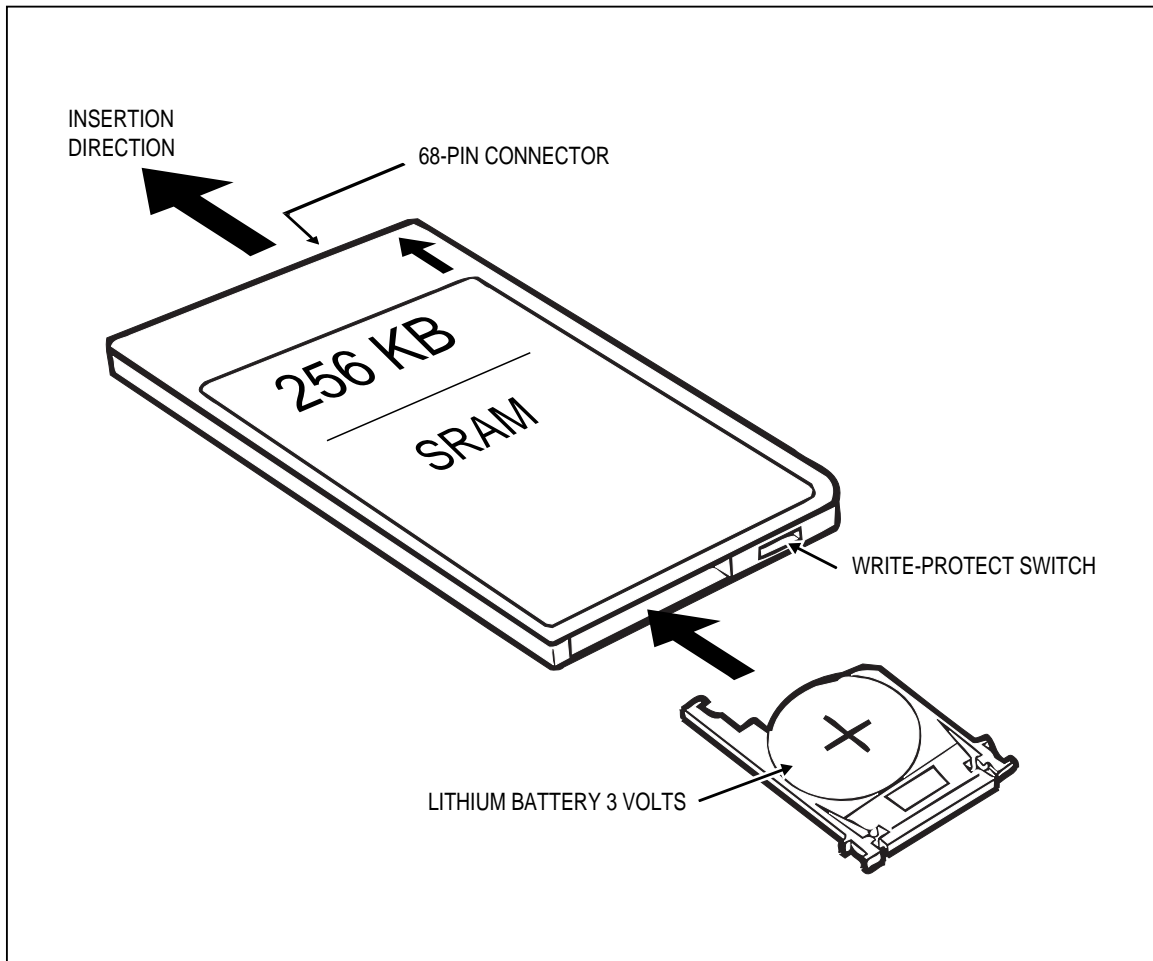

Figure 3-1. Typical Memory Card

op37f.eps

### Memory Card Files

Two types of memory card files are used. Files that store instrument configurations are setup files, SETxx, and files that store measurement data are data files, dAtxx, where xx is an integer from 00 to 99. The number xx can be assigned by the instrument or selected by the operator. When the assigned integer reaches 99, previous integers available from erased files or numbers skipped over are reassigned for subsequent new files. The memory card can contain a maximum of 100 SETxx and 100 dAtxx files.

### Setup Files

When the front panel controls have been used to configure channels for a particular instrument application, including type of measurement, alarms, scaling, rate, and all other operating parameters, this configuration can be saved as a SEtxx files. If this is the first setup file saved on the memory card, the instrument will assign 00 for the file name SEt00, or you can select your own file number. The instrument displays only the SEtxx portion, but all files are appended with the extension .HYD. Subsequent setup files would be SEt01, SEt02, and so on. The user should note the file name assigned or selected for a particular instrument configuration. A directory of card files are easily viewed and print out using the directory feature (Figure 3-10). Setup files allow the entire instrument to be configured for an operation in and instant. The “Logger” applications software can be used to create setup files that are tagged with a user-defined string.

### Data Files

Data files, dAtxx, are opened automatically at scanning when the memory card is selected as a destination for measurement data. The display will indicate the file being opened. For example, pressing the **SCAN** key will display dAt00 (for the first data file on the memory card), which is acknowledged by pressing **ENTER**, and then the scanning begins. A file number can be selected as well. The instrument displays only the dAtxx portion, but all files are appended with the extension .HYD. If scanning is stopped, then resumed without changing instrument configuration or the memory card, the data will be appended to the opened file. If any parameter is changed or the memory card is changed, the next scan cycle will open a new dAtxx file. Extraction measurement data from the data files is accomplished by a PC running Starter or Logger applications software. The data is read to the PC from the memory card in the instrument, using an RS-232 link, or the memory card can be taken to a PC equipped with a memory card reader (optional - see Table 1-2, “Options and Accessories”). The PC Logger applications software allows separate data files to be edited and combined into a single file.

### Memory Card Capacity

An empty 256K-byte memory card (supplied) will store 4,800 scans of ten channels; an empty 1M-byte memory card (optional) will store 19,800 scans of ten channels. SRAM memory cards are available in a variety of sizes. When scanning and recording data onto the memory card, the front panel indicates what percentage of the memory card has been used (Figure 3-2). For example, a display of 74Pct indicates 74% of the card has been used.

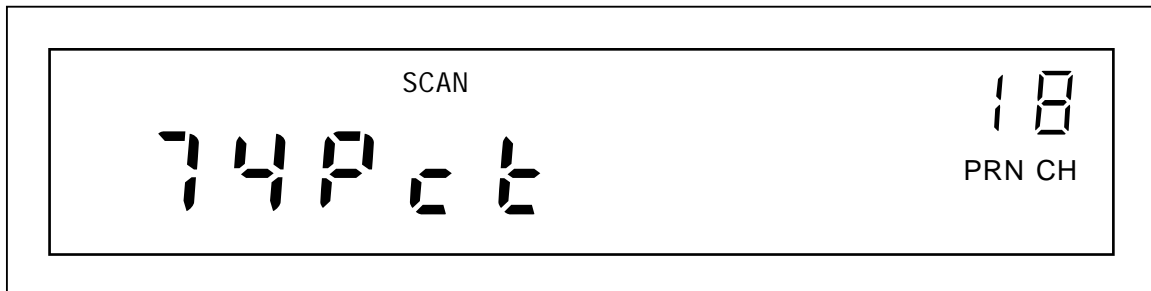

Figure 3-2. Front Panel Memory Card Percent Display

op38f.eps

### **Memory Card Battery**

A typical SRAM is powered by an internal lithium 3-volt battery that has a minimum life of five years for a 256K-byte card, and two years for a 1M-byte card. If the battery voltage falls below 2.75 volts, the front panel BATT indicator will light (see Figure 1-1). Battery life is reduced in applications with high ambient temperature.

## **Inserting and Removing the Memory Card**

Memory card operations that involve inserting and removing the card are described below. Any illegal memory card operations result in an instrument double "beep" and an error message. Error messages are summarized in Table 3-1.

### **Inserting a Memory Card**

To insert the memory card into the instrument, orient the card so the insertion-direction arrows are on top and point towards the card reader slot. Push the card at the center of the edge into the slot until resistance is noted, then firmly push until seated in the connector. If the instrument responds with a double beep and error message, the inserted card is unformatted (see the initialization procedure in Figure 3-3).

### **Removing a Memory Card**

To remove the memory card from the instrument, press the ejection button to the right of the card (see Figure 1-1). The button should be pressed firmly until it becomes flush with the instrument front panel. This action ejects the card from the connector and pushes it free of the reader assembly. Grasp the card and remove from the instrument.

### **Changing the Memory Card During Scanning**

When recording measurement data to a memory card that is nearly full (as noted by the percent indication), remove the memory card in the normal way when the BUSY indicator is off. Then insert a new memory card (be sure it is formatted), which will automatically open a file with the same number and continue recording data. For example, if scanning started with dAt17 on the original card, dAt17 will be opened on the replacement card. If the same file already exists on the replacement card, e.g., dAt17, an error message appears. No data is lost during this operation as the instrument stores up to 75 scans when the memory card is removed during scanning, and the new memory card is immediately updated with this stored data. The PC software "Logger" allows separate memory card files to be combined into a single file.

### **Setting the Memory Card Write-protect Feature**

The memory card (Figure 3-1) has a write-protect switch that can be positioned to prevent the writing of data to the card, the erasing of any dAtxx or SEttx file, or the initialization of the memory card. Normally, this switch is placed in the read/write position. However, if the card has critical data that should be protected, the switch is placed in the write-protect (read only) position.

## **Installing or Replacing the Memory Card Battery**

To install or replace the battery in the memory card, follow the instructions supplied with the memory card. A typical battery installation is shown in Figure 3-1. Memory card batteries are readily available from supply houses serving the computer industry (typically 3V dc, Panasonic BR2325, Maxell CR2025, or equal).

**Table 3-1. Memory Card Error Codes**

Error	Probable	Cause
Err 1 Card	CARD ERROR- Unable to use a card (Note 1): Card is missing or card is not fully inserted. Card is unformatted. Write-protect switch in the read -only position. Card is 100% full of data	Install a memory card (Fig. 3-1). Initialize a memory card (Fig. 3-3). Reposition switch (Fig. 3-1). Erase files (Fig. 3-7/3-9) or use another card.
Err 2 FILE	FILE ERROR- Unable to open a file (Note 1): The selected file name already exists.  All file names are assigned (SEt00, SEt99 or dAt00 to dAt99).	Choose another file name (Fig. 3-5/3-8) or erase files (Fig. 3-7/3-9). Erase files (Fig. 3-7/3-9) or use another card.
Err 3 bAd	CARD PROBLEM (Scans Saved) (Note 1): Card exchanged during scanning is unformatted.  Card exchanged during scanning is full of data.  Replacement card has a duplicate file name. (Note 4).	Use a formatted card (Note 2).  Use a different card (Note 2).  Use a different card (Note 2).
Err 4 bAd	CARD PROBLEM (Scans Lost) (Note 1): Same as Err 3 bAd (Note 3).	
Err 3 FULL	CARD IS FULL (Scans Saved) (Note 1): Card is 100% full of data.	Use a different card (Note 2).
Err 4 FULL	CARD IS FULL (Scans Lost) (Note 1): Same as Err 3 FULL (Note 3)	

*Note 1: Err 1 and Err 2 are non-scanning errors that occur only before scanning starts. Err 3 and Err 4 are scanning errors that occur only after scanning starts.*

*Note 2: Err 3 indicates scans are being saved in an internal memory (75 scans) while the memory card error is being resolved. Err 4 indicates scans are bin lost because the internal memory overflowed (75 scans) before the error was corrected. When a suitable exchange card is inserted, the internal memory updates the card with the stored scans.*

*Note 3: When memory cards are exchanged during scanning and the replacement card has a problem, Err 3/Err 4 is appended with the word bAd. When the memory card used for scanning becomes full of data, Err 3/Err 4 is appended with the word FULL.*

*Note 4: When memory cards are exchanged during scanning, the replacement card must have the same file name available as was used for the original scan. If this file name already exists on the replacement card, and Err 3/Err 4 will occur.*

## Initializing a Memory Card

Perform the procedure in Figure 3-3 to initialize (format) a memory card. Memory cards can also be formatted at a PC if it is equipped with a memory card reader. (Formatting at a PC uses the format utility supplied with the memory card reader.) When the memory card is formatted, a standard DOS file system and directory are put into the memory on the card. To exit at any time (formatting not completed), press the **CANCL** key.

*Note*

*Any scan data that may be stored in the internal memory waiting to be written to a valid memory card (see paragraph 3-8 Changing the Memory Card During Scanning) will be lost when formatting a memory card.*

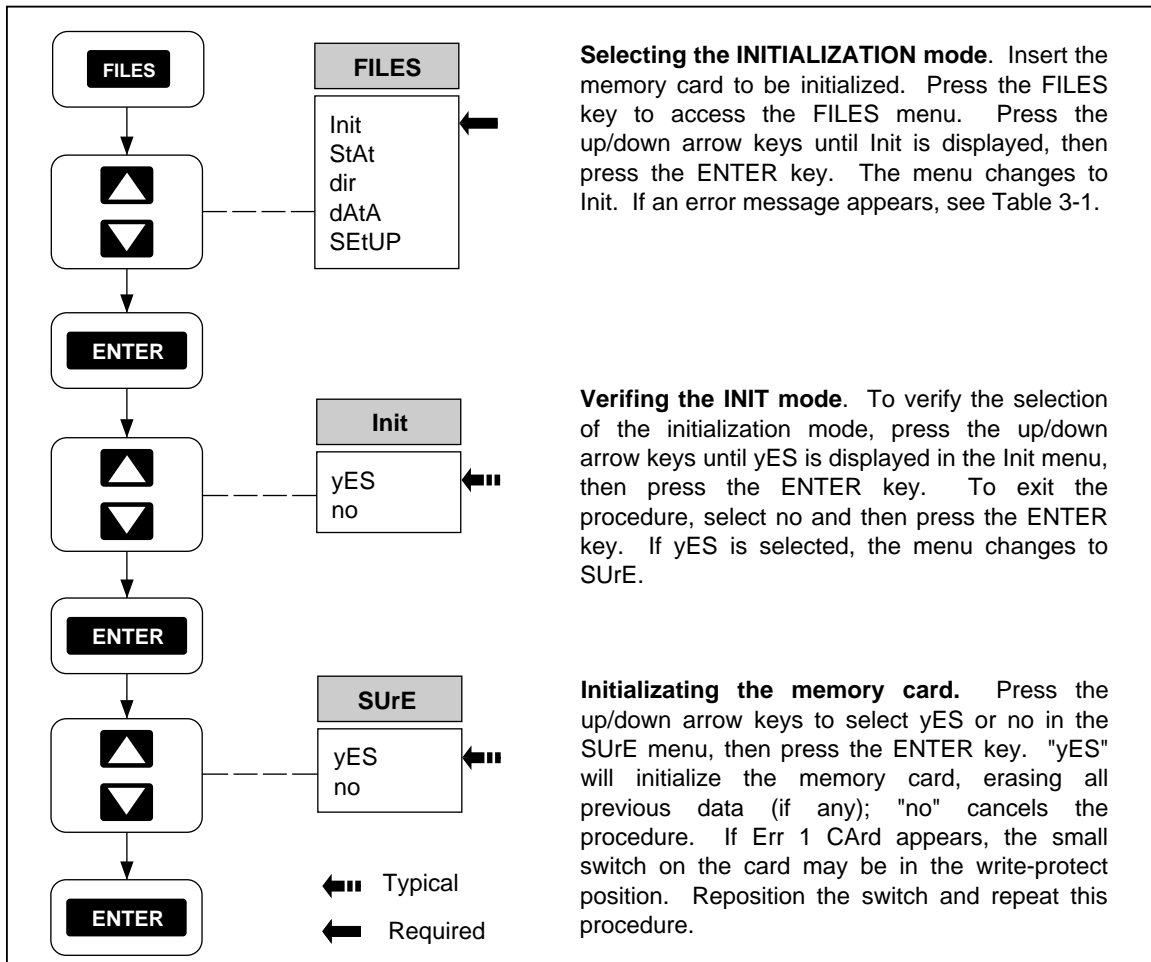

Figure 3-3. Initializing a Memory Card

op39f.eps

## Recording Measurement Results During Scanning

Perform the procedure in Figure 3-4 to record measurement results onto the memory card. The destination for the scanned data can be the memory card, printer, both the memory card and printer, or no destination, where the results are not saved, except in the Review array (last, maximum, and minimum scanned values) and in the 100-scan internal memory FIFO (First In First Out) log queue. (The internal memory log queue is accessed only through the computer interface. See Chapter4, "Computer Operations.")The mode for recording to the memory card or printer can be all scanned data, scanned data only when any scanned channel is in alarm, or single scans when an alarm transitions into or out of alarm.

### Note

*Measurement results recorded onto a memory card are extracted only by a PC running the Starter or Logger applications software. If printed results are desired as well as recording to the memory card, then "both" must be selected in the procedure below and a printer must be connected to the RS-232 port. See Chapter5, Printer Operations, for more information.*

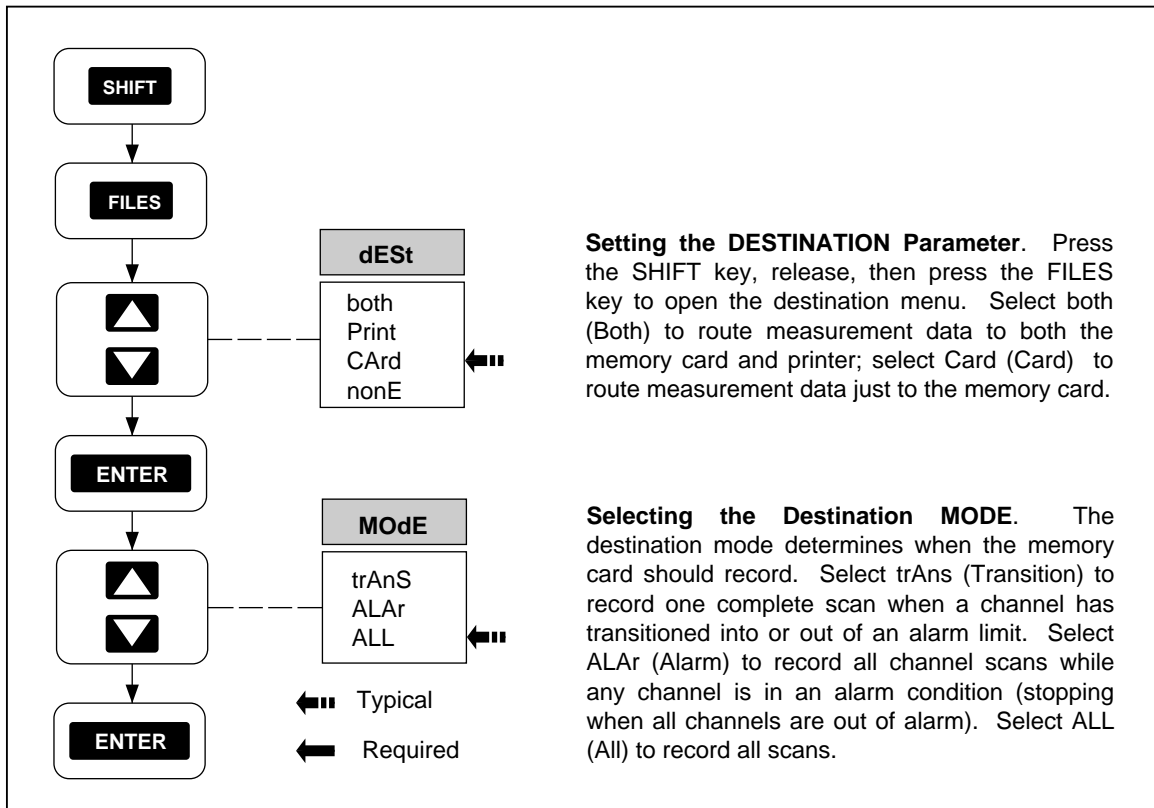

Figure 3-4. Recording Measurement Results During Scanning

op40f.eps



## Setup File Procedures

Perform the following procedures to LOAD, STORE, and ERASE memory card instrument configuration (SEtUP) files.

### Using Setup Store

Perform the procedure in Figure 3-5 to save the current instrument configuration. The communication parameters: baud, parity, CTS, and echo, remain as set previously by the front panel controls or computer interface. The instrument automatically assigns the next sequential SEtxx file name. When SEt99 is reached, the instrument loops back to reuse previously assigned file names that have been erased or skipped over. To assign your own file name, use the up/down and left/right arrow keys when creating the file.

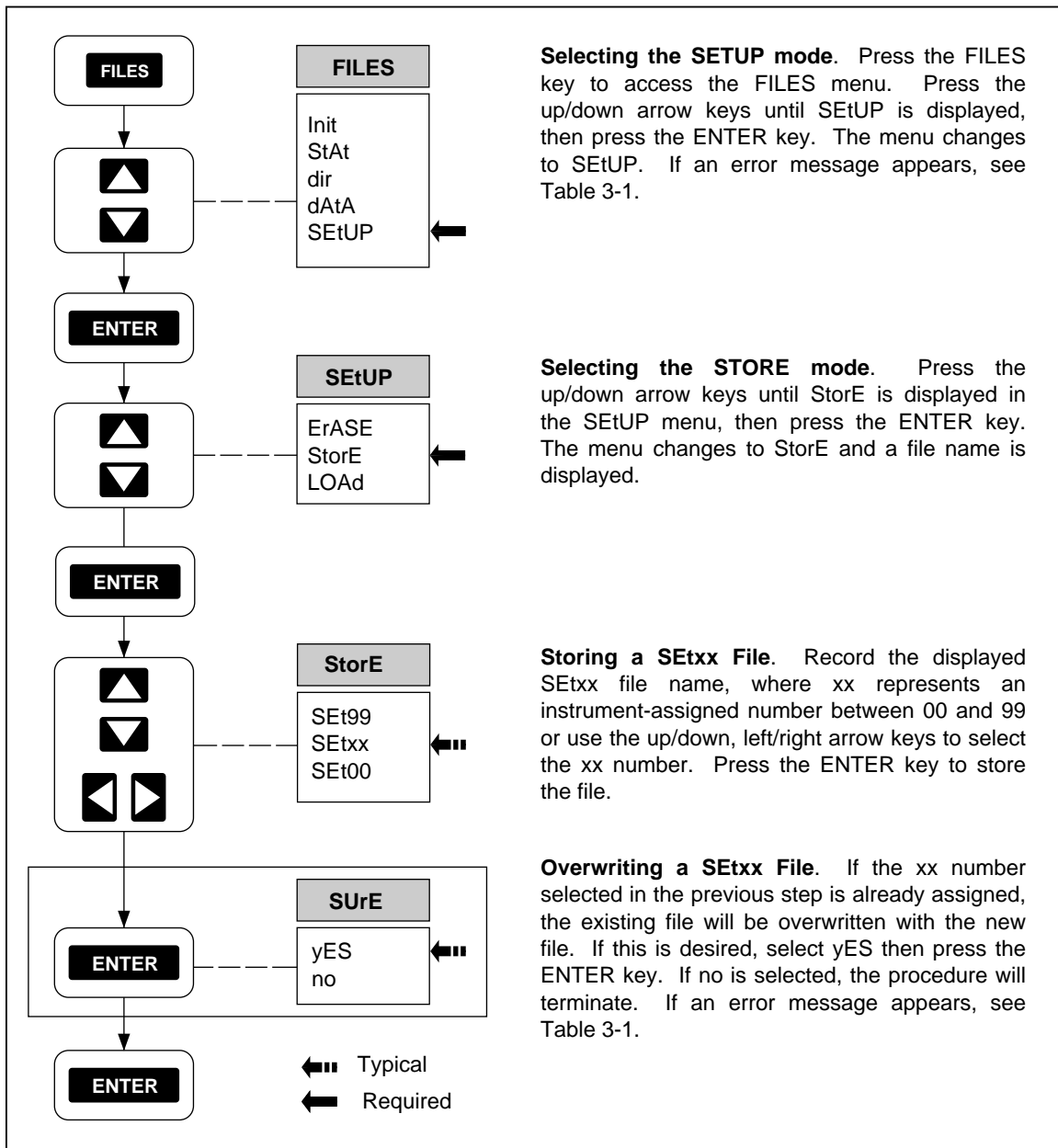

Figure 3-5. Using SETUP STORE to Save Configuration Files

op41f.eps

### Using Setup Load

Perform the procedure in Figure 3-6 to discard the current instrument configuration and load a configuration saved in a previous SETUP STORE operation (Figure 3-5). A configuration file includes channel configurations, scan interval, measurement rate, alarms, Mx+B scaling, and temperature unit (°C or °F). Communication parameters, baud, parity, CTS, and echo remain as set previously by the front panel controls. To exit at any time (file not loaded), press the **CANCL** key.

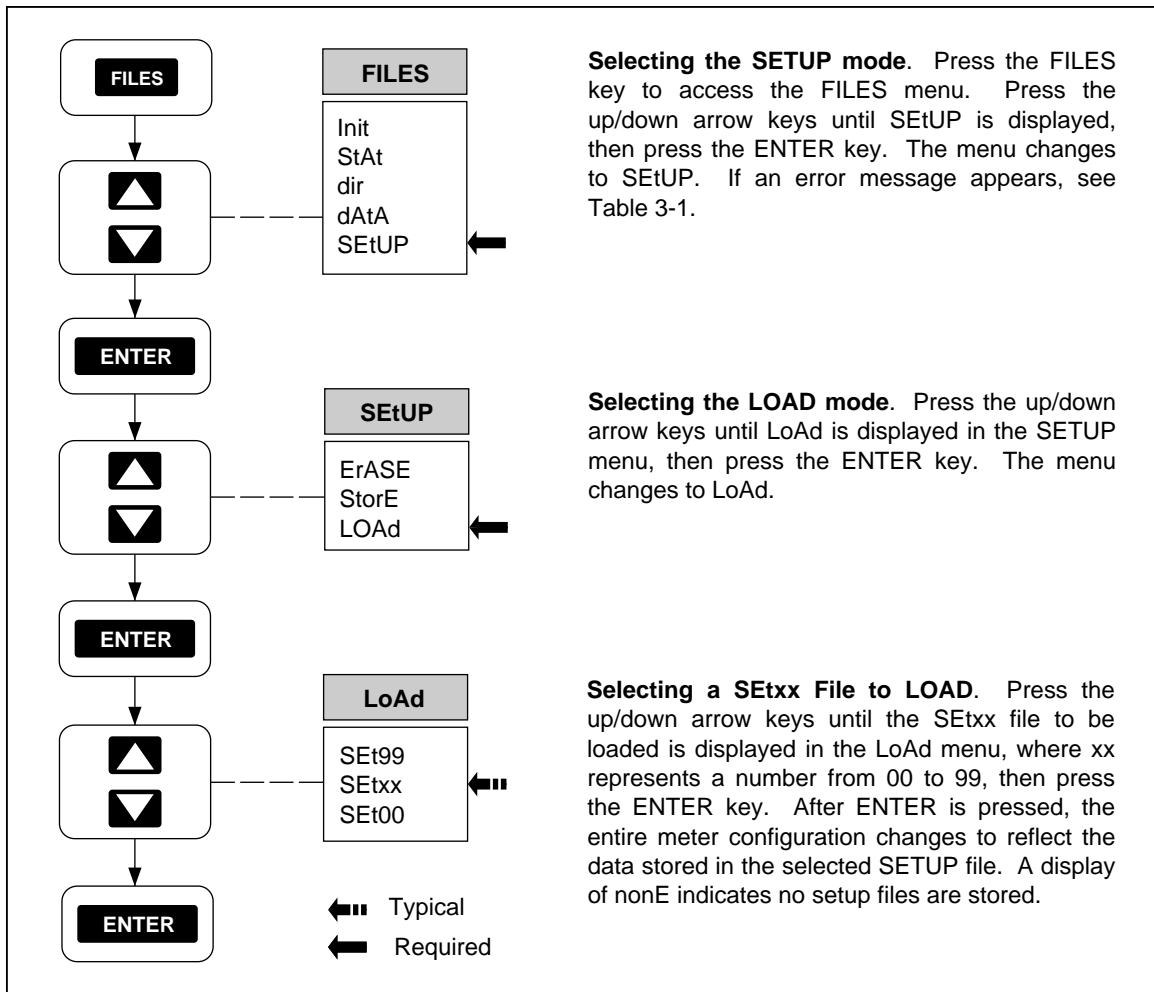

Figure 3-6. Using SETUP LOAD to Load Configuration Files

op42f.eps

### Using Setup Erase

Perform the procedure in Figure 3-7 to remove a setup file from the memory card. Removing a file does not interrupt the sequential SETxx file names assigned with the SETUP STORE command. When SET99 is reached, the instrument loops back to reuse previously assigned file names that have been erased or skipped over. To exit at any time (file not erased), press the **CANCL** key.

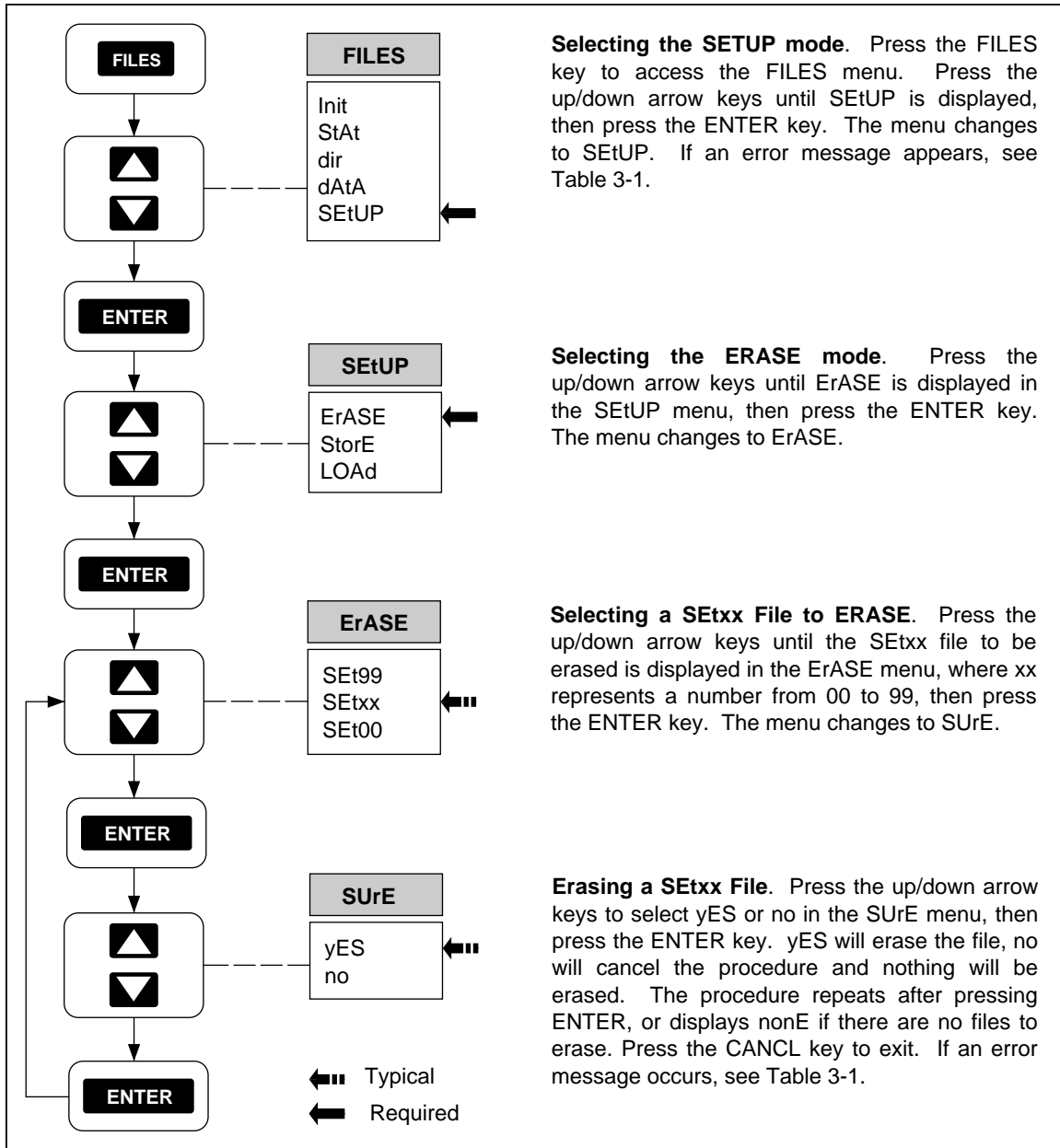

Figure 3-7. Using SETUP ERASE to Delete Configuration Files

op43f.eps

## Data File Procedures

Perform the following procedures to OPEN, LOAD, STORE, and ERASE memory card instrument data (DATA) files.

### Using Data Open

Perform the procedure in Figure 3-8 to open a data file in preparation for recording measurement data to the memory card. This procedure is automatically invoked if the **SCAN** key is pressed and the instrument is configured for memory card operations. The instrument automatically assigns the next sequential dAtxx file name. To assign your own file name, use the up/down and left/right arrow keys when creating the file. When dAt99 is reached, the instrument loops back to reuse previously assigned file names that have been erased or skipped over. Data cannot be appended to an existing file, except in the case where scanning is turned off and on without changing the instrument configuration. Before using the DATA OPEN command, verify the instrument is configured for measurement. If a file is opened and then the instrument configuration is changed, the file will automatically be closed.

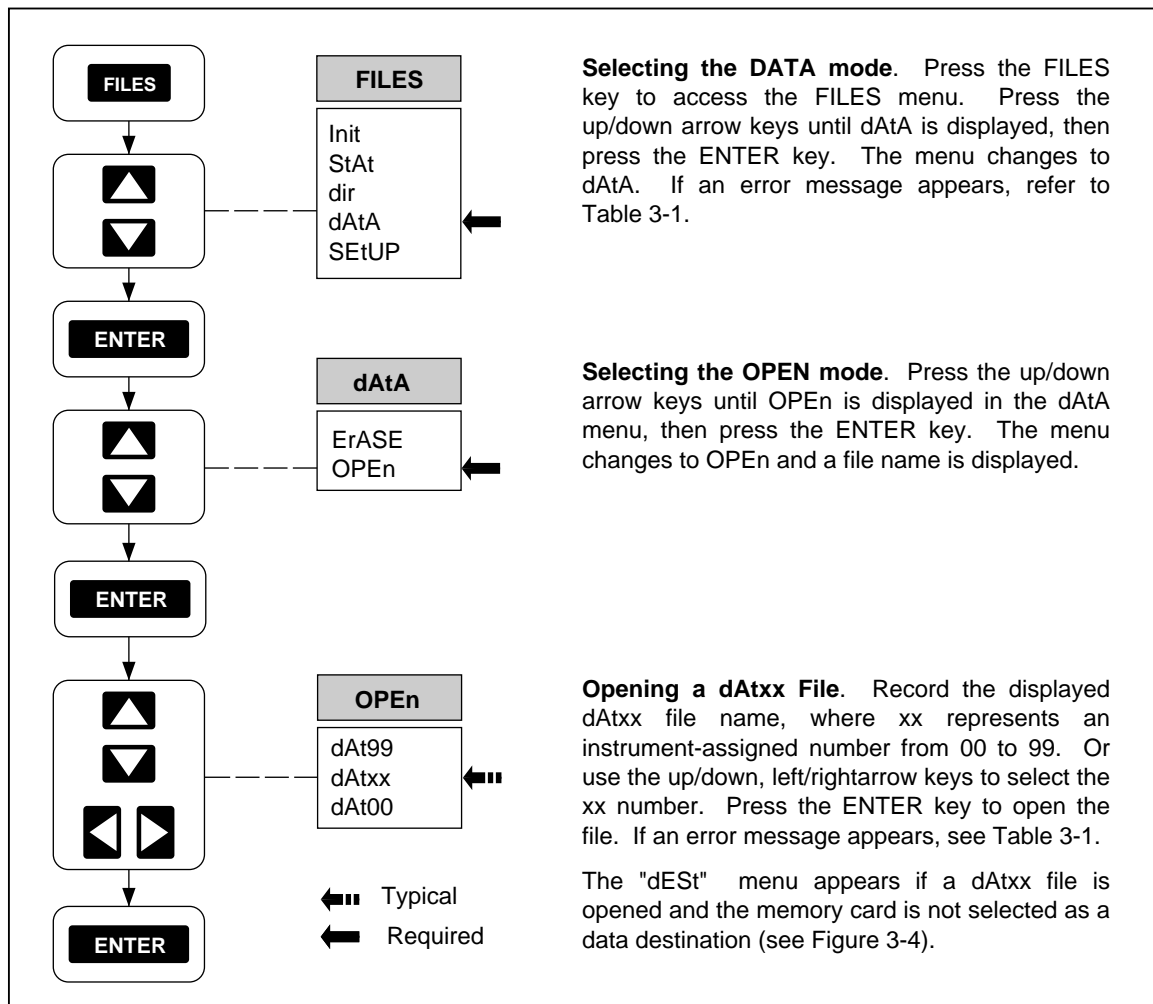

Figure 3-8. Using DATA OPEN to Save Measurement Data in a File

op44f.eps

### Using Data Erase

Perform the procedure in Figure 3-9 to remove a data file from the memory card. Removing a file does not interrupt the sequential dAtxx file names assigned with the DATA OPEN command. When dAt99 is reached, the instrument will loop back and reuse previously assigned file names that have been erased or skipped over. To exit at any time (file not erased), press the **CANCL** key.

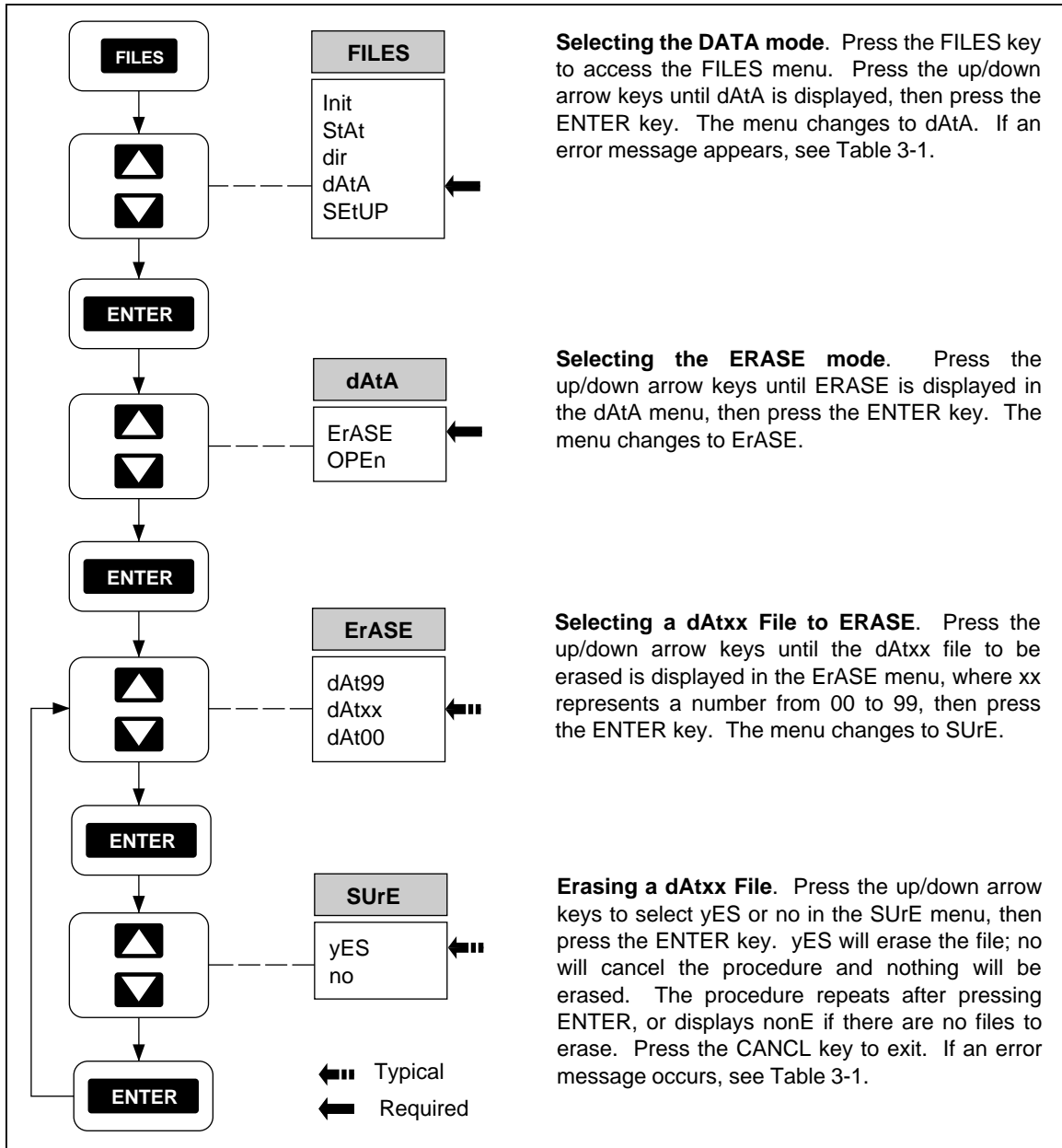

Figure 3-9. Using DATA ERASE to Delete a Measurement Data File

op45f.eps

## Setup and Data Files Directory

Perform the procedure in Figure 3-10 to obtain a directory of existing SEtxx files and dAtxx files that exist on the memory card, plus the remaining capacity of the card. The size of the selected file is given in the front panel display in K-bytes. To exit at any time (directory not completed), press the **CANCL** key.

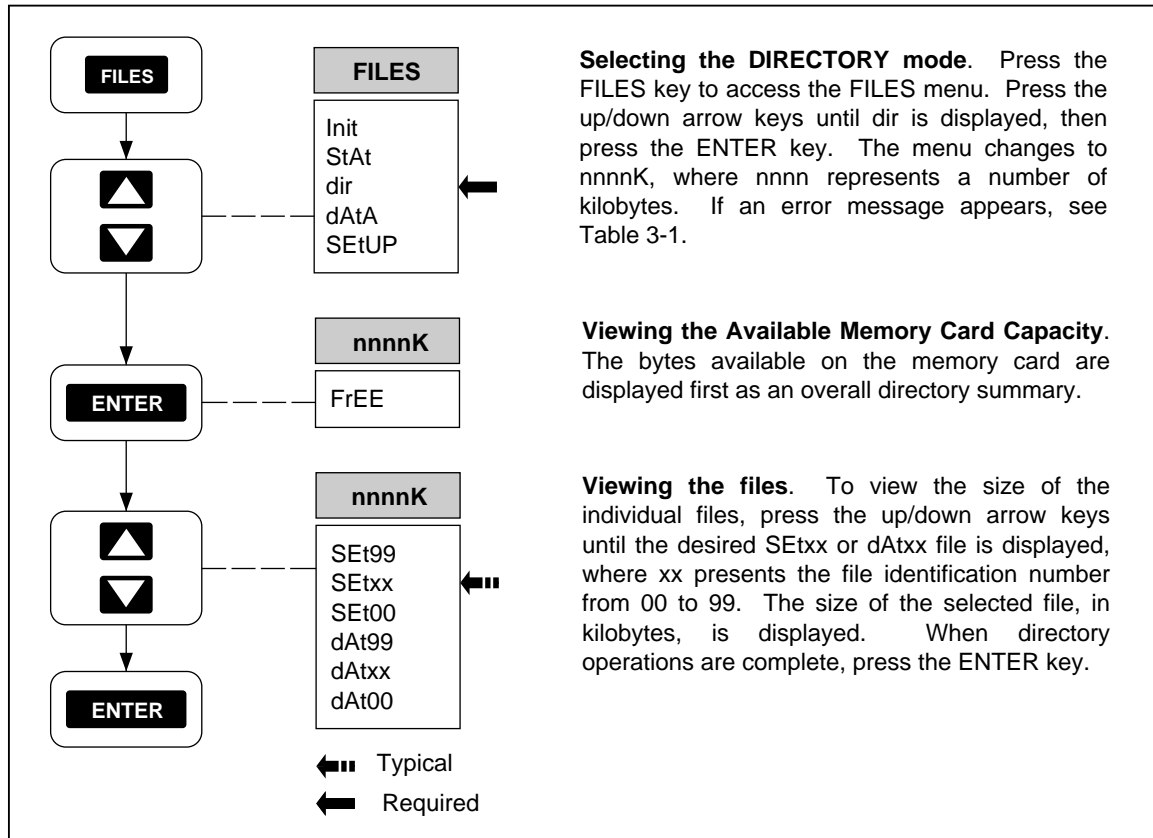

Figure 3-10. Using DIRECTORY to Examine SETUP and DATA files

op46f.eps

## Setup and Data File Current Status

Perform the procedure in Figure 3-11 to display the status of the memory card SEtxx and dAtxx files that are currently in effect or were in effect for the most recent scan. The xx portion of the file name represents a file identification number from 00 to 99.

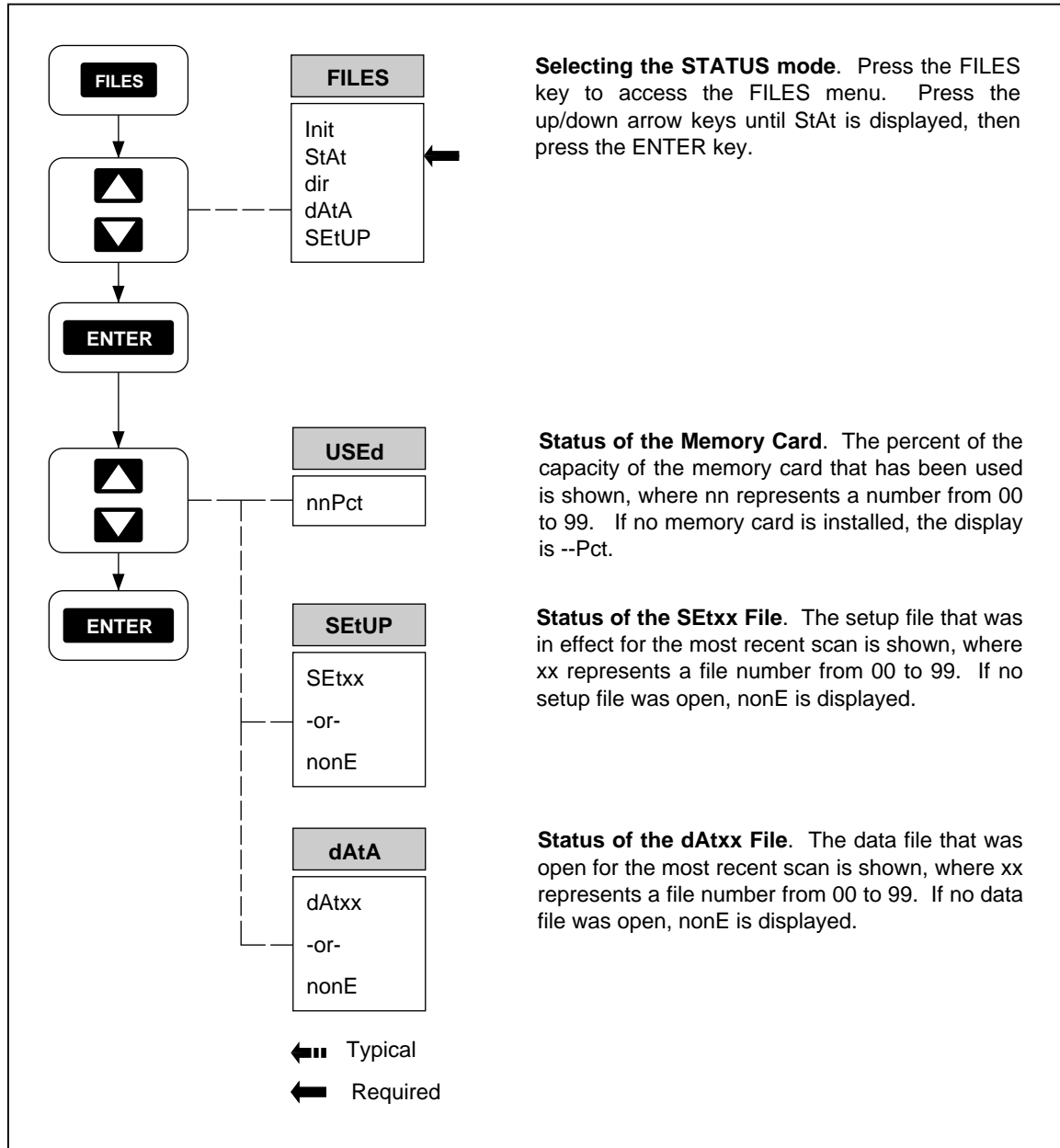

Figure 3-11. Using STATUS to Examine SETUP and DATA Files

op47f.eps

## ***Memory Card File Operations to and from a PC***

All memory card file transfers to and from the instrument are controlled at the PC. Nothing is required at the instrument end, except to have the RS-232 link operating correctly (see Chapter4, "Computer Operations") and having the desired memory card installed in the instrument front panel. Refer to the applications software documentation supplied with Starter (supplied) or Logger (optional).



## **Chapter 4**

# **Computer Operations**

<b>Title</b>	<b>Page</b>
Summary of Computer Operations.....	4-3
Connecting the Instrument to a PC.....	4-3
Configuring the Instrument for Computer Operations .....	4-5
Configuring the PC for Computer Operations .....	4-6
Testing the Instrument/PC RS-232 Interface .....	4-6
Testing the RS-232 Interface Using Terminal Emulation (Windows) .....	4-6
Testing the RS-232 Interface Using Terminal Emulation (Generic) .....	4-7
Testing the RS-232 Interface Using Gwbasic.....	4-9
Testing the RS-232 Interface Using Qbasic.....	4-10
Computer Interface Commands and Operation.....	4-12
How the Instrument Processes Input.....	4-12
Input Terminators.....	4-12
Input String Examples.....	4-13
Sending Numeric Values to the Instrument .....	4-13
How the Instrument Processes Output.....	4-13
Status Registers .....	4-14
Instrument Event Register (IER) .....	4-14
Standard Event Status Register (ESR).....	4-16
Status Byte Register (STB).....	4-17
Computer Interface Command Set.....	4-18
Xmodem File Transfers .....	4-18

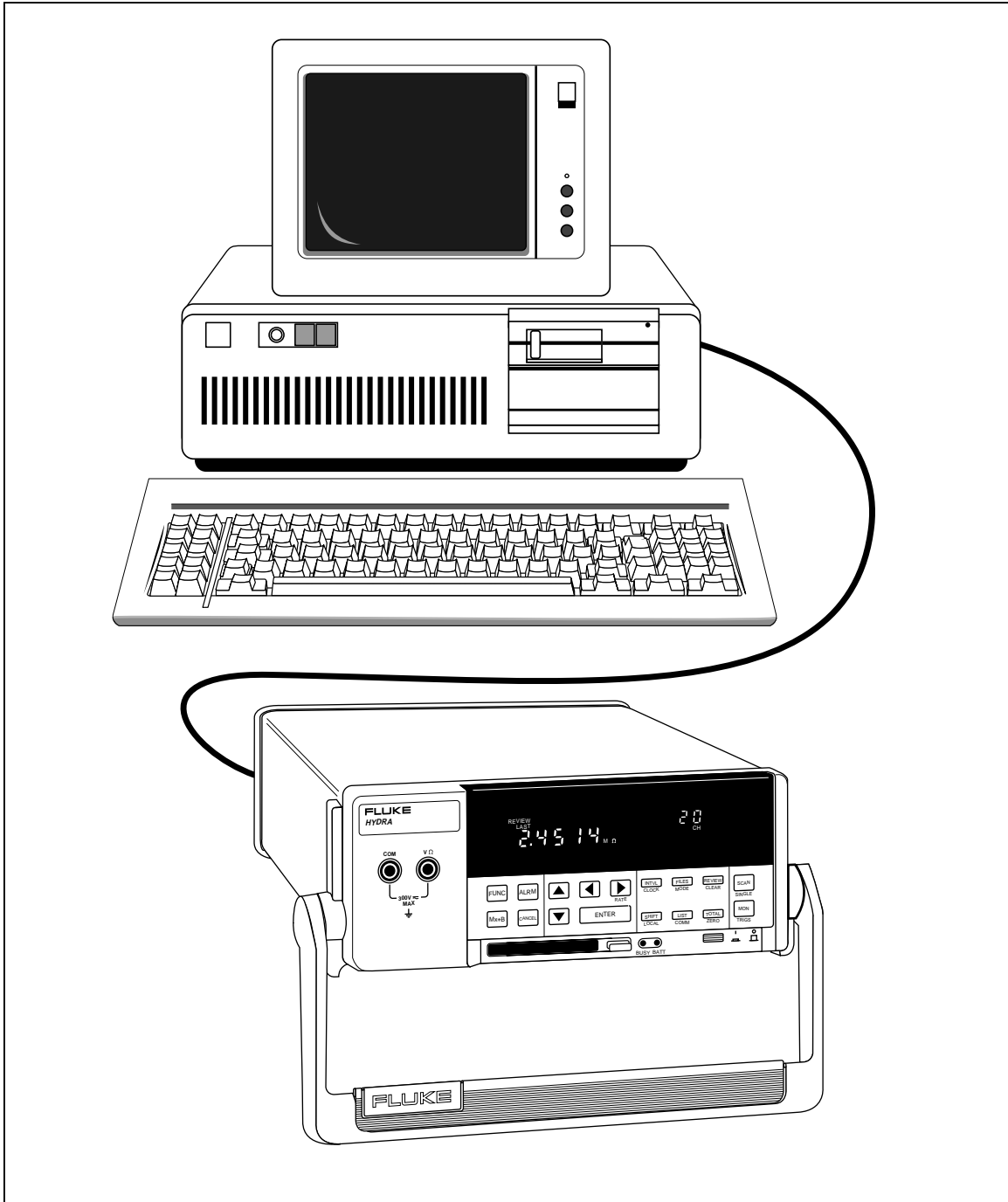

op82f.eps

## **Summary of Computer Operations**

Computer operations allow the instrument to be configured and controlled from a personal computer (PC), including data exchanges with the instrument memory card. The computer interface is via an RS-232 link between the instrument RS-232 port and a PC serial COM port. The PC gives operation and configuration commands to the instrument, and the instrument returns status signals (alarms, for example) and scan measurement data. PC operations can be in real time with a dedicated RS-232 connection, or the instrument can be connected to a PC for configuration and then removed for distant operations. Memory Card features are described in Chapter 3, Memory Card Operations.

PC applications software Hydra Series II Starter Package (Starter) and Hydra Series II Logger Package (Logger) (optional) operate the RS-232 computer interface. The software packages are described in separate technical manuals; however, each accomplishes the following:

- |                                 |  |
|---------------------------------|--|
| Starter (supplied)              | Starter is a menu-driven software package used to transfer configuration data from and to the instrument, log measurement data collected by the instrument, and manage the acquired data.  |
| Logger (optional) configuration | Hydra Series II Logger is an optional full featured Windows based and data logging package. It can communicate with two Hydras at once and can also utilize telephone modems for remote applications. A brochure with complete details is available. |

Custom software can be developed by the user in GWBASIC, Quick BASIC (QBASIC), or Quick C using the computer interface command set, which is described in this chapter.

The RS-232 computer interface between a instrument and a PC is discussed in the following paragraphs in this sequence:

- Connecting the Instrument to a PC
- Configuring the Instrument for Computer Operations
- Configuring the PC for Computer Operations
- Testing the Instrument/PC RS-232 Interface
- Computer Interface Commands and Operation

## **Connecting the Instrument to a PC**

The two most common configurations for connecting the instrument to a PC are shown in Figure 4-1. The instrument RS-232 port (DB-9 connector) is cabled to a PC serial COM port that uses either a DB-9 connector or DB-25 connector. The connecting cable can be fabricated (see Appendix D) or ordered from Fluke as an option (see Chapter 1).

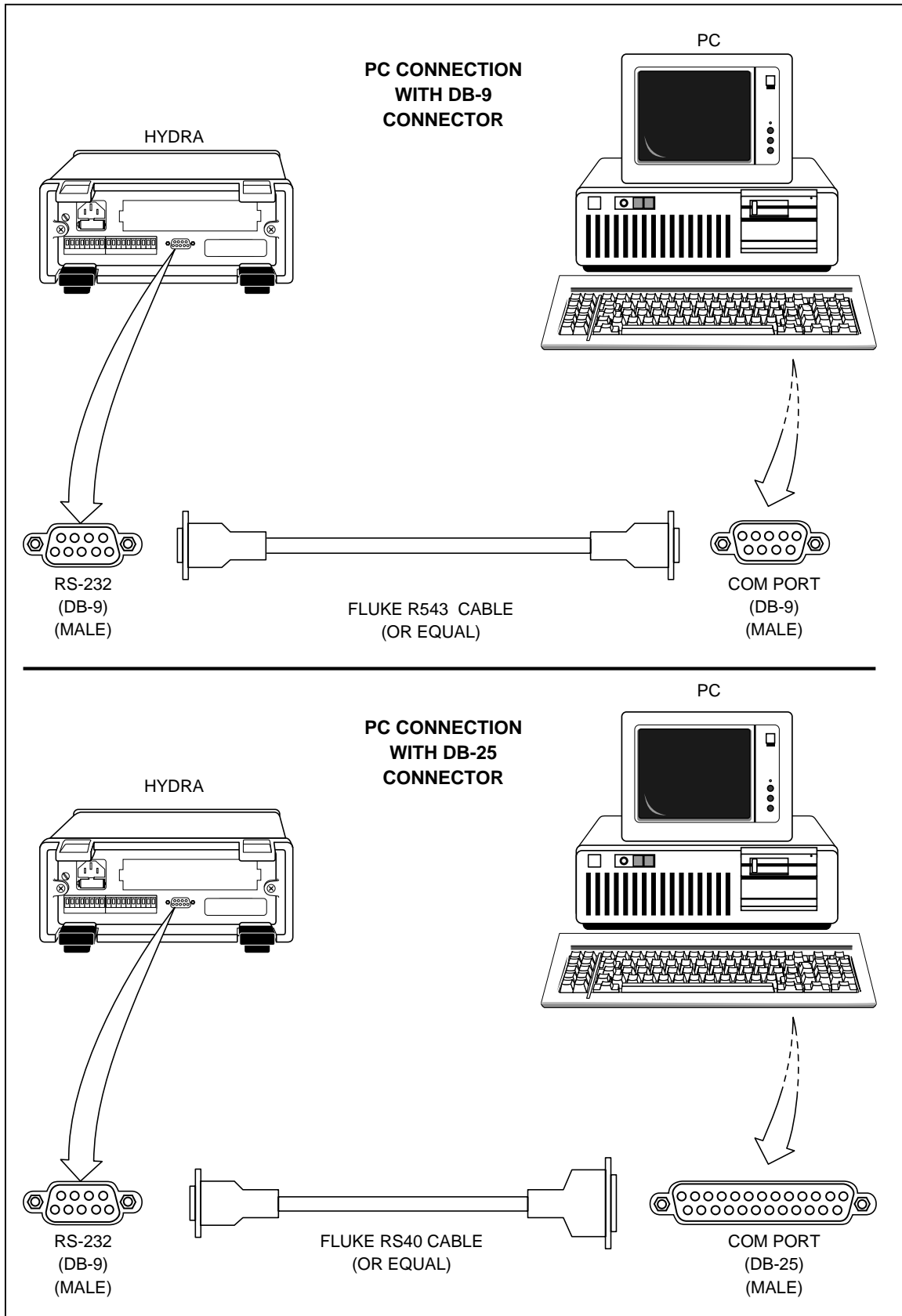

op48f.eps

Figure 4-1. Connecting the Instrument to a PC

## Configuring the Instrument for Computer Operations

Correct operation of the interface between the instrument and PC depends on the baud rate, parity, CTS (Clear To Send) and echo of the RS-232 interface parameters. Perform the procedure in Figure 4-2 to establish these parameters for the instrument. The instrument uses one stop bit, which is not selectable.

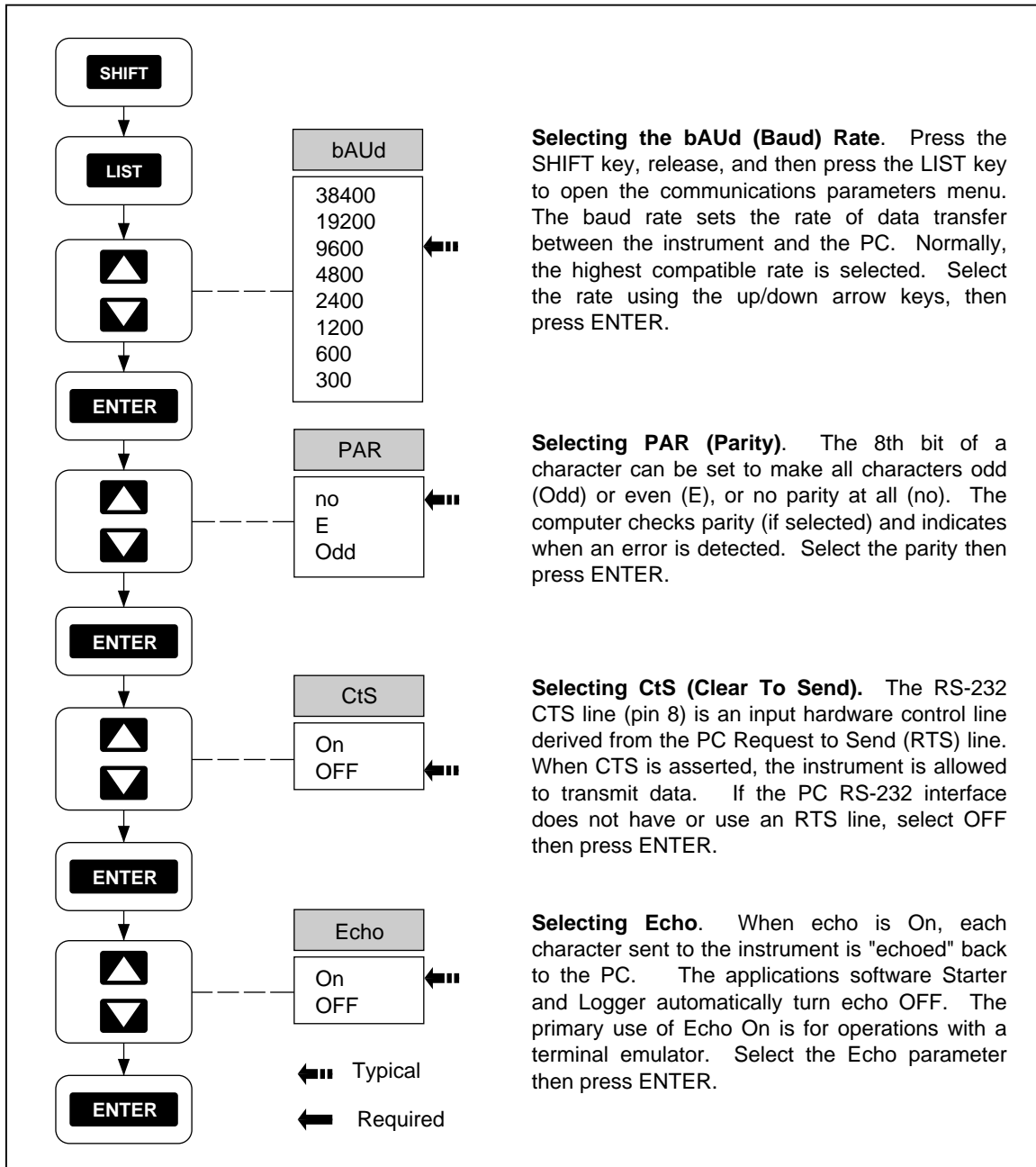

Figure 4-2. Configuring the Instrument for Computer Operations

op49f.eps

## **Configuring the PC for Computer Operations**

Operation of the instrument from a PC always involves software, either software supplied with the instrument (Starter) or software developed by the user (GWBASIC, QBASIC or Quick C). Since the PC COM port is set up by the operating software, there is no separate configuration procedure.

## **Testing the Instrument/PC RS-232 Interface**

The RS-232 link between the instrument and PC should be tested before it is used for communications. Since DOS commands cannot test the link, some form of software control is required. Four procedures are provided:

- Testing using terminal emulation (Windows)
- Testing using terminal emulation (Generic)
- Testing using commands while in GWBASIC
- Testing using commands while in QBASIC

The RS-232 computer interface can also be tested using the TERM (Terminal) mode in both Starter and Logger applications software. Refer to the technical manuals supplied with the software for the test procedures.

### **Testing the RS-232 Interface Using Terminal Emulation (Windows)**

Complete the procedure below to test the RS-232 link between the PC and instrument using the PC Windows terminal emulator. Identify the PC COM port used for the RS-232 link (COM1 is assumed).

1. Configure the Data Bucket communication parameters, as described in Figure 4-2, for bAUd = 9600, PAR = no, CtS = OFF, and Echo = On.
2. Turn on the PC, start Windows, open the Accessories menu and select Terminal.
3. Open the Terminal Settings menu and select Communications.
4. In Communications, select the following, then use OK to exit to Terminal:

Connector COM1 [Typical]

Baud Rate 9600

Data Bits 8

Stop Bits 1

Parity None

Flow ControlNone

5. In Terminal, request the Data Bucket to send its identification number by entering: \*IDN? <Enter>. If \*IDN? did not appear on the screen as the characters were entered, be sure the instrument RS-232 port is configured for Echo = On (Figure 4-2). If the wrong characters appear, there is an incompatibility in the COM port configurations (baud rate, parity, etc.). If everything seems normal, but characters still don't appear, check the RS-232 connection cable (see Appendix D). When the RS-232 link is operating correctly, the instrument returns an identification string and execution prompt similar to the following:

```
FLUKE,2635A,0,Mn.n An.n Dn.n Ln.n
```

```
=>
```

Mn.n identifies the main software version.

An.n identifies the analog-to-digital converter software version.

Dn.n identifies the display software version.

Ln.n identifies the programmable gate-array configuration version.

6. Other commands can be entered from the PC to gain familiarity with the instrument command set. All commands are summarized in Table 4-4 and explained in Table 4-5.

For example: to reset the instrument, configure channel 0 to measure volts dc using the 300V DC scale (scale 4), send scan results to the RS-232 port, and scan once, enter the following:

\*RST[Resets the instrument (which does not affect the communication parameters)]

=>

FUNC 0, VDC, 4[Set channel 0 to volts dc and scale 4 (300V DC)]

=>

PRINT\_TYPE 0,0[Sets the data destination as the RS-232 port, and all data]

=>

PRINT 1[Enables data logging to the RS-232 port]

=>

\*TRG [Triggers a single scan]

=>

15:17:0407/21/94

0:000.00 VDC

ALM:15DIO:255TOTAL:0

To decode the printout, see Figure 5-3.

The commands in the above example can be combined into a single entry by using the semicolon separator character:

\*RST;FUNC 0,VDC,4;PRINT\_TYPE 0,0;PRINT 1;\*TRG.

7. One of the following three possible prompts are returned when a command is sent to the instrument:
  - => The command was executed[Example, PRINT 1].
  - !> The command was recognized, but not executed [Example, PRINT 3, where only PRINT 0 and PRINT 1 are legal entries].
  - ?> The command wasn't recognized [Example, PRITN 1, spelling error].
8. Exit Windows and return to DOS, as required.

### **Testing the RS-232 Interface Using Terminal Emulation (Generic)**

Complete the procedure below to test the RS-232 link between the PC and instrument using a generic terminal emulator. Refer to the documentation appropriate to the selected communications/terminal emulation software, as required. Identify the PC COM port used for the RS-232 link (COM1 is assumed).

1. Configure the Data Bucket communication parameters, as described in Figure 4-2, for bAUd = 9600, PAR = no, CtS = OFF, and Echo = On.
2. Turn on the PC, start the communications software, and open the COM port configuration screen.
3. Select the following communications parameters  
Connector COM1 [Typical]  
Baud Rate 9600  
Data Bits 8  
Stop Bits 1  
Parity None  
Flow ControlNone[May be called the RTS/CTS line]
4. In Terminal, request the Data Bucket to send its identification number by entering: \*IDN? <Enter>. If \*IDN? did not appear on the screen as the characters were entered, be sure the instrument RS-232 port is configured for Echo = On (Figure 4-2). If the wrong characters appear, there is an incompatibility in the COM port configurations (baud rate, parity, etc.). If everything seems normal, but characters still don't appear, check the RS-232 connection cable (see Appendix D). When the RS-232 link is operating correctly, the instrument returns an identification string and execution prompt similar to the following:

```
FLUKE,2635A,0,Mn.n An.n Dn.n Ln.n
```

```
=>
```

Mn.n identifies the main software version.

An.n identifies the analog-to-digital converter software version.

Dn.n identifies the display software version.

Ln.n identifies the programmable gate-array configuration version.

5. Other commands can be entered from the PC to gain familiarity with the instrument command set. All commands are summarized in Table 4-4 and explained in Table 4-5.

For example: to reset the instrument, configure channel 0 to measure volts dc using the 300V DC scale (scale 4), send scan results to the RS-232 port, and scan once, enter the following:

```
*RST [Resets the instrument (which does not affect the communication parameters)]
```

```
=>
```

```
FUNC 0, VDC, 4 [Set channel 0 to volts dc and scale 4 (300V DC)]
```

```
=>
```

```
PRINT_TYPE 0,0 [Sets the data destination as the RS-232 port, and all data]
```

```
=>
```

```
PRINT 1 [Enables data logging to the RS-232 port]*TRG [Triggers a single scan]
```

```
=>
```

```
15:17:04 07/21/94
```

```
0: 000.00 VDC
```



ALM:15 DIO:255 TOTAL:0

To decode the printout, see Figure 5-3.

The commands in the above example can be combined into a single entry by using the semicolon separator character:

\*RST;FUNC 0,VDC,4;PRINT\_TYPE 0,0;PRINT 1;\*TRG.

6. One of the following three possible prompts are returned when a command is sent to the instrument:
  - => The command was executed [Example, PRINT 1].
  - !> The command was recognized, but not executed [Example, PRINT 3, where only PRINT 0 and PRINT 1 are legal entries].
  - ?> The command wasn't recognized [Example, PRITN 1, spelling error].
7. Exit the communications program and return to DOS, as required.

**Testing the RS-232 Interface Using Gwbasic**

Complete the procedure below to test the RS-232 link between the PC and instrument using GWBASIC interpreter commands. Identify the PC COM port used for the RS-232 link (COM1 is assumed).

1. Configure the Data Bucket communication parameters, as described in Figure 4-2, for bAUd = 9600, PAR = no, CtS = OFF, and Echo = On.
2. Turn on the PC and enter GWBASIC to start the BASIC interpreter.
3. With the entry screen displayed, enter the following commands (which are executed immediately). The last command returns an identification string and execution prompt:

OPEN "COM1,9600,N,8,1,CS,CD" FOR RANDOM AS #1

OK

PRINT #1, "\*IDN?"

OK

PRINT INPUT\$ (46, #1)

IDN?

FLUKE,2635A,0,Mn.n An.n Dn.n Ln.n

=>

Mn.n identifies the main software version.

An.n identifies the analog-to-digital converter software version.

Dn.n identifies the display software version.

Ln.n identifies the programmable gate-array configuration version.

If the identification string was not returned, be sure the instrument RS-232 port is configured for Echo = On (Figure 4-2). Verify that the commands were exact. For example, entering PRINT #1, "\*IDN" instead of PRINT #1, "\*IDN?" will hang up the program. Press <CNTL><BREAK> to escape, then re-enter the commands. If the wrong characters appear, there is an incompatibility in the COM port configurations (baud rate, parity, etc.). If everything seems normal, but characters still don't appear, check the RS-232 connection cable (see Appendix D).

One of the following three possible prompts are returned when a command is sent to the instrument:

- => The command was executed [Example, PRINT 1].
- !> The command was recognized, but not executed [Example, PRINT 3, where only PRINT 0 and PRINT 1 are legal entries].
- ?> The command wasn't recognized [Example, PRITN 1, spelling error].

4. Other commands can be entered from the PC to gain familiarity with the instrument command set. All commands are summarized in Table 4-4 and explained in Table 4-5. For example: to reset the instrument, configure channel 0 to measure volts dc using the 300V DC scale (scale 4), send scan results to the RS-232 port, and scan once, enter the following [only the output of the last command is shown]:

```
PRINT #1, "*RST":PRINT INPUT$(10, #1)
PRINT #1, "FUNC 0, VDC,4":PRINT INPUT$(18, #1)
PRINT #1, "PRINT_TYPE 0,0":PRINT INPUT$(20, #1)
PRINT #1, "PRINT 1":PRINT INPUT$(13, #1)
PRINT #1, "*TRG":PRINT INPUT$(83, #1)
15:17:0407/21/94
0:000.00 VDC
ALM:15DIO:255TOTAL:0
```

To decode the printout, see Figure 5-3.

The commands in the above example can be combined into a single entry by using the semicolon separator character:

```
PRINT #1, "*RST;FUNC 0,VDC,4;PRINT_TYPE 0,0;PRINT 1;*TRG":PRINT INPUT$(124, #1)
```

If other commands are entered, remember that the input character count xxx for PRINT INPUT\$(xxx, #1) command must be exact. A number too small will not read all the characters and will leave residual characters in the buffer, while a number too big will "hang up" the command until more characters are loaded into the buffer or <CNTRL><BREAK> is pressed, which erases the buffer.

5. Enter SYSTEM to exit GWBASIC and return to DOS.

### **Testing the RS-232 Interface Using Qbasic**

Complete the procedure below to test the RS-232 link between the PC and instrument using QBASIC compiler commands. Identify the PC COM port used for the RS-232 link (COM1 is assumed).

1. Configure the Data Bucket communication parameters, as described in Figure 4-2, for bAUd = 9600, PAR = no, CtS = OFF, and Echo = On.
2. Turn on the PC and enter QBASIC to start the BASIC compiler.
3. With the entry screen displayed, enter the following commands (which are not executed immediately):

```
OPEN "COM1,9600,N,8,1,CS,CD" FOR RANDOM AS #1
PRINT #1, "*IDN?"
```

PRINT INPUT\$(46, #1)

4. Enter SHIFT<F5> to run the program entered in step 3. If the RS-232 interface is operating correctly, the instrument returns an identification string and execution prompt similar to the following:

\*IDN?

FLUKE,2635A,0,Mn.n An.n Dn.n Ln.n

=>

Mn.n identifies the main software version.

An.n identifies the analog-to-digital converter software version.

Dn.n identifies the display software version.

Ln.n identifies the programmable gate-array configuration version.

If the identification string was not returned, be sure the instrument RS-232 port is configured for Echo = On (Figure 4-2). Verify that the commands were exact. For example, entering PRINT #1, "\*IDN" instead of PRINT #1, "\*IDN?" will hang up the program. Press <CNTL><BREAK> to escape, then re-enter the commands. If the wrong characters appear, there is an incompatibility in the COM port configurations (baud rate, parity, etc.). If everything seems normal, but characters still don't appear, check the RS-232 connection cable (see Appendix D).

One of the following three possible prompts are returned when a command is sent to the instrument:

=>           The command was executed [Example, PRINT 1].

!>           The command was recognized, but not executed [Example, PRINT 3, where only PRINT 0 and PRINT 1 are legal entries].

- ?> The command wasn't recognized [Example, PRITN 1, spelling error].

5. Other commands can be entered from the PC to gain familiarity with the instrument command set. All commands are summarized in Table 4-4 and explained in Table 4-5. For example: to reset the instrument, configure channel 0 to measure volts dc using the 300V DC scale (scale 4), send scan results to the RS-232 port, and scan once, enter the following, then enter SHIFT<F5> to run [only the output of the last command is shown]:

PRINT #1, "\*RST":PRINT INPUT\$(10, #1)

PRINT #1, "FUNC 0, VDC,4":PRINT INPUT\$(18, #1)

PRINT #1, "PRINT\_TYPE 0,0":PRINT INPUT\$(20, #1)

PRINT #1, "PRINT 1":PRINT INPUT\$(13, #1)

PRINT #1, "\*TRG":PRINT INPUT\$(83, #1)

15:17:0407/21/94

0:000.00 VDC

ALM:15DIO:255TOTAL:0

To decode the printout, see Figure 5-3.

The commands in the above example can be combined into a single entry by using the semicolon separator character:

```
PRINT #1, "*RST;FUNC 0,VDC,4;PRINT_TYPE 0,0;PRINT 1;*TRG":PRINT  
INPUT$(124, #1)
```

If other commands are entered, remember that the input character count `xxx` for `PRINT INPUT$(xxx, #1)` command must be exact. A number too small will not read all the characters and will leave residual characters in the buffer, while a number too big will "hang up" the command until more characters are loaded into the buffer or `<CNTL><BREAK>` is pressed, which erases the buffer.

6. Use Exit to exit QBASIC and return to DOS.

## ***Computer Interface Commands and Operation***

Operation of the computer interface between the instrument and PC normally involves the application software Starter (supplied) and Logger (optional), described in separate manuals. This chapter is provided for the user who wishes to develop his own software interface using the instrument command set. The topics in this chapter include:

- How the Instrument Processes Input
- Input Terminators
- Input String Examples
- Sending Numeric Values to the instrument
- How the Instrument Processes Output
- Status Registers
- Computer Interface Command Set

### ***How the Instrument Processes Input***

The instrument processes and executes valid input character strings from the host personal computer (PC). A valid input string is one or more syntactically correct commands, separated by semicolons (;) followed by an input terminator. The instrument stores received inputs in a 350-byte buffer. When an input string is received, it is not executed or checked for proper syntax until the input terminator is received. If the 350-byte input buffer becomes full, a device-dependent error prompt is returned, and further inputs to the string are ignored, except for a termination character. The instrument accepts alphabetic characters in either upper- or lower-case. If a command cannot be understood, the command and the rest of the command line are ignored.

Commands must be entered in the correct order as follows:

1. Commands to configure the instrument.
2. Commands that trigger a measurement.
3. Commands to read the results of a triggered measurement.
4. Commands to reconfigure the instrument (if any).

### ***Input Terminators***

An input terminator is a character sent by the host that identifies the end of a string. When the input terminator is received, the instrument executes all commands entered since the last terminator was received, on a first-in, first-out basis. If a communications error (e.g., parity, framing, overrun) is detected, a device-dependent error is generated. Valid terminators are LF (line feed), CR (carriage return), CR LF, and LF CR. In some

instances, a terminator is automatically transmitted by the host at the end of the command string, for example, commands entered in BASIC.

### ***Input String Examples***

Below are four input string examples. Example 1 - Select function for channel 1 as ohms, 30-k range, 2-wire connection.

FUNC 1, OHMS, 3, 2 <CR/LF>

Example 2 - Select function for channel 12 as temperature, using K-type thermocouple.

FUNC 12, TEMP, K <CR/LF>

Example 3 - Select function for channel 7 as temperature, using platinum RTD, 2-wire connection -and- set a new R0 [0 as in zero] value on the same channel of 101.22.

FUNC 7, TEMP, PT, 2;RTD\_R0 7, 101.22 <CR/LF>

Example 4 - Set the interval between scans to 10 minutes -and- start scanning -and- return the most recent measurement values for all scanned channels.

INTVL 0, 10, 0;SCAN 1;LAST? <CR/LF>

### ***Sending Numeric Values to the Instrument***

Numeric values can be sent to the instrument as integers, real numbers, or real numbers with exponents, as shown in the following examples:

+12345Sends the signed integer+12345

123.45Sends the real number123.45

1.2345E+2Sends the number -1.2345 x 10<sup>2</sup>

### ***How the Instrument Processes Output***

The instrument outputs alphanumeric character strings in response to a query command from the host. A query command always ends with "?" (see Tables 4-4 and 4-5). An instrument output string is terminated by a CR/LF (carriage return/line feed). When the host sends a string to the instrument, wait for the instrument to return a prompt before sending another command string. If a second command is sent before the prompt is returned, a device-dependent command error (!>) is generated and the second string is ignored. The prompts are in one of three forms:

=>           The command was executed.

[Example, PRINT 1]

!>           The command was recognized but couldn't be executed.

[Example, PRINT 3, which has no meaning]

?>           The command was not recognized due to syntax error.

[Example, PRITN 1, spelling error]

Numeric outputs from the instrument are either integer values or scientific notation values. For example:

The query command RANGE? returns the number 3.

The query command ALARMS? returns the number 0.

A measurement returns +1.2345E+6 (1.2345x10<sup>6</sup>).

Positive overload (OL on display) returns +001.00E+9

Negative overload (-OL on display) returns -001.00E+9

Open thermocouple (otc on display) returns +009.00E+9

### **Status Registers**

Internal instrument operation is summarized in three data registers, which can be accessed to determine various events and status conditions before, during, and after instrument operation. Each register has a corresponding enable register to enable or mask (disable) any or all data register outputs. The relationship between the three registers is shown in Figure 4-3.

#### ***Instrument Event Register (IER)***

The inputs to the Instrument Event Register (IER) include Scan Complete, Configuration Corrupted, Calibration Corrupted, Open Thermocouple, Totalize Overflow, and Alarm Limit Transition. Each input is described in Table 4-1. The output byte of the IER is ANDed with the output byte of the corresponding Instrument Event Enable Register (IEE). When there is logic high correlation between any of the bits of the IER and IEE registers, the associated Logical OR gate will output a logic high to the Instrument Event Bit (IEB) in the Status Byte Register.

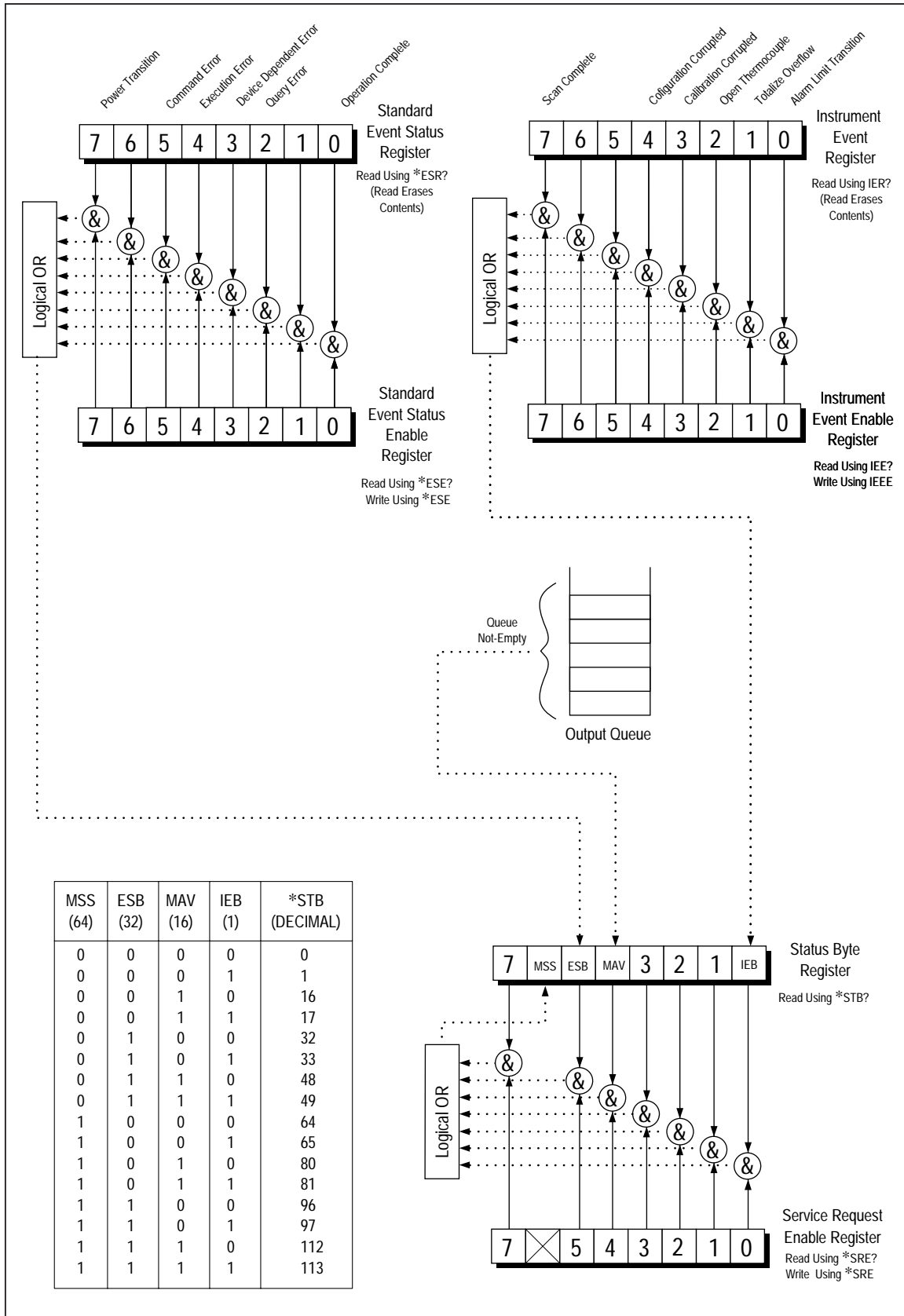

Figure 4-3. Overview of Status and Event Data Registers

op50f.eps

For example, an IER byte of binary 10000000 (decimal 128) indicates Scan Complete. If the IEE register is set to binary 10000000 (using the command IEE 128), then a Scan Complete condition will cause the Logical OR gate to output a logic high. In a similar manner, parameters can be combined. An IER byte of binary 10000101 (decimal 133) and an IEE set to a corresponding binary 10000101 (using the command IEE 133), will cause the Logical OR gate to have a logic high output for any of three conditions: Scan Complete -or- Open Thermocouple -or- Alarm Limit Transition.

Other commands include IER?, which returns the decimal equivalent of the IER byte and then clears the register to zero, and IEE?, which returns the decimal equivalent of the IEE byte. The command \*CLS will clear all event registers. (See Appendix E for an 8-bit binary-coded-decimal table.)

**Table 4-1. Instrument Event Register (IER)**

Bit	Name	Description
0	ALT	Alarm Limit Transition. Set high (1) when any measurement value has transitioned into or out of alarm. Alarms are defined through the front panel or the computer interface (ALARM_LIMIT). This bit is cleared when read with IER? and when alarms or review values are cleared.
1	TOB	Totalize Overflow. Set high (1) when the Totalizer overflows (65,535). This bit is cleared when read with IER? and when the Totalizer is zeroed from the front panel or set to some other non-overflow value (,65,535) with the computer interface TOTAL command.
2	OTC	Open Thermocouple. Set high (1) when open thermocouple checking is enabled (with TEMP_CONFIG command) and any thermocouple channel is measured with a source impedance greater than 1 to 4 kilohms.
3	CCB	Calibration Corrupted. Set high (1) when the instrument calibration data is corrupted. When a calibration data check shows a corruption of calibration data, the calibration alarm bit remains set in the Instrument Status Register until the instrument is recalibrated.
4	CNC	Configuration Corrupted. the instrument configuration stored in NVRAM has been found to be corrupted. The RAM CRC is no longer valid.
5,6	not used	Always set to 0.
7	SCB	Scan Complete. Set high (logic 1) when a measurement scan has been completed. This bit is cleared when read with IER?
<b>NOTES</b>		
<i>Whenever the Instrument Event Register is read, the condition bits are cleared.</i>		
<i>This register is used in conjunction with the Instrument Event Enable Register to determine the conditions under which the Instrument Event Bit of the Status Byte is set.</i>		

**Standard Event Status Register (ESR)**

The inputs to the Standard Event Status Register (ESR) include Power On, Command Error, Execution Error, Device Dependent Error, Query Error and Operation Complete. Each input is described in Table 4-2. The output byte of the ESR is ANDed with the output byte of the corresponding Standard Event Status Enable (ESE) register. When there is logic high correlation between any of the bits of the ESR and ESE registers, the



associated Logical OR gate will output a logic high to the Event Status Bit (ESB) in the Status Byte Register.

For example, an ESR byte of binary 00010000 (decimal 16) indicates an Execution Error. If the ESE register is set to binary 00010000 (using the command \*ESE 16), then an Execution Error condition will cause the Logical OR gate to output a logic high. In a similar manner, parameters can be combined. An ESR byte of binary 00110000 (decimal 48) and an ESE set to a corresponding binary 00110000 (using the command \*ESE 48), will cause the Logical OR gate to have a logic high output for any of two conditions: Command Error or Execution Error.

Other commands include \*ESR?, which returns the decimal equivalent of the ESR byte and then clears the register to zero, and \*ESE?, which returns the decimal equivalent of the ESE byte. The command \*CLS will clear all event registers. (See Appendix E for an 8-bit binary-coded decimal table.)

**Table 4-2. Event Status Register (ESR)**

Bit	Name	Description
0	OPC	Operation Complete. set true (1) upon execution of the *OPC command, indicating that the instrument has completed all selected pending operations
1	not used	Always set to 0.
2	QYE	Query Error. Sets the QYE bit of the ESR. Example would be *IDN?; *ESR? (vs. *ESR?; *IDN?). This causes the "?>" prompt to be returned.
3	DDE	Device Dependent Error. Generated true (1) by overflows of the RS-232 input buffer or by calibration errors. This causes the "!>" prompt to be returned.
4	EXE	Execution Error. Generated true (logic 1) by parameters out of bounds or by a valid command that could not be processed due to an internal condition (such as calibration commands being received when calibration is not enabled). This causes the "!>" prompt to be returned.
5	CME	Generated true (1) by syntax errors, including: unrecognized command and incorrect command sequences. This causes the "?>" prompt to be returned.
6	not used	Always set to 0
7	PON	Power Transition. Set true (logic 1) after an off-to-on transition has occurred in the instrument's power supply.

**Status Byte Register (STB)**

The inputs to the Status Byte Register (STB) include the Instrument Event Bit, Event Status Bit, and Message Available Bit. In addition, the STB register generates a Master Summary Status. Each input is described in Table 4-3. The output byte (except for bit 6) is ANDed with the output byte of the corresponding Service Request Enable Register (SRE). When there is a logic high correlation between any of the bits of the STB and SRE registers, the associated Logical OR gate will output a logic high that is used as a Master Summary Status (MSS) bit.

For example, an STB byte of binary 00100000 (decimal 32) indicates an Event Status Bit. If the SRE register is set to binary 00100000 (using the command \*SRE 32), then an Event Status Bit will cause the Logical OR gate to output a logic high, which automatically sets bit 6 to high via the MSS input. Therefore, a query of the STB register (command \*STB?) would return decimal 96 (binary 01100000).

Other commands include \*SRE?, which returns the decimal equivalent of the SRE byte. The command \*CLS will clear all event registers. (See Appendix E for an 8-bit binary-coded decimal table.)

**Table 4-3. Status Byte Register (STB)**

Bit	Name	Description
0	IEB	Instrument Event Bit. When any bit in the Instrument Event Register is set and the corresponding mask bit(s) in the Instrument Event Enable register is set, this Instrument Event Bit in the Status Byte will be set. When read, the Instrument Event Bit is recomputed based on the new value from the Instrument Event Register and its mask, the Instrument Event Enable Register.
1,2,3	not used	Always set to 0.
4	MAV	Message Available (ASCII bytes available for output).
5	ESB	Event Status Bit
6	MSS	Master Summary Status
7	not used	Always set to 0.

### **Computer Interface Command Set**

Table 4-4 is a summary of computer interface commands and queries. A detailed description of each command or query, with examples, can be found in Table 4-5. Sample programs that use the command set are shown in Figure 4-4 (GW BASIC), Figure 4-5 (QBASIC) and Figure 4-6 (Quick C). Program examples are provided on the Starter application software floppy disk.

### **Xmodem File Transfers**

The FILE\_TX and FILE\_RX computer commands are used to transfer memory card files in binary format over the RS-232 interface. The protocol implemented for file transfers is XMODEM, an 8-bit block-oriented protocol using CRC or checksums for error checking. When receiving a file, the protocol attempts to do CRCs but will fall back to checksums if CRCs are not sent. When FILE\_TX and FILE\_RX are used with terminal emulators, the emulator must support the XMODEM protocol; for example, the PC Windows terminal emulator. The PC software must support both 128-byte and 1024-byte data blocks. Since XMODEM is an 8-bit protocol, no parity must be selected when configuring the RS-232 ports and XON/XOFF flow control cannot be used.

When a FILE\_TX or FILE\_RX command is issued, it returns an immediate execution error prompt (!>) if the file transfer can not be initiated. If this prompt is not returned, then the XMODEM transfer may begin (refer to the communications software being used for the procedure to send or receive a binary file). When the file transfer is complete, the => prompt is returned. If an unrecoverable error occurred, the !> prompt is returned. As with any XMODEM transfer, the last block received, if it is not an even multiple of 128 or 1024 bytes, is padded with nulls. See the FILE\_RX and FILE\_TX commands in Table 4-5 for more information.

**Table 4-4. Command and Query Summary**

<b>Alarms</b>	
ALARMS?	Active Alarms Query
ALARM_ASSOC	Associate Alarm Output
ALARM_ASSOC?	Alarm Association Query
ALARM_ASSOC_CLR	Clear Alarm Association
ALARM_DO_LEVEL	Set Alarm Output Level
ALARM_DO_LEVELS?	Alarm Output State Query
ALARM_LIMIT	Set Alarm Limit
ALARM_LIMIT?	Alarm Limit Assignments Query
<b>Communications</b>	
ECHO	Turn the RS-232 Echo Mode on and off
<b>Digital I/O</b>	
DIO_LEVELS?	Digital I/O State Query
DO_LEVEL	Set Digital Output Level
<b>Function and Range</b>	
FUNC	Channel Function Definition
FUNC?	Channel Function Query
RTD_R0	RTD Ice Point (R0)
RTD_R0?	RTD Ice-Point (R0) Query
RANGE?	Channel Range Query
<b>Logging</b>	
LOG?	Retrieve Logged Data Query
LOGGED?	Scan Data Query
LOG_BIN?	Binary Upload of Logged Data
LOG_CLR	Clear Logged Scans
LOG_CLR1	Clear Oldest Logged Scan
LOG_COUNT?	Logged Scan Count Query
LOG_MODE	Action when Internal Memory is Full
LOG_MODE?	Action when Internal Memory is Full Query
PRINT	Data Logging Enable/Disable
PRINT?	Data Logging Query
PRINT_TYPE	Set Data Logging Type
PRINT_TYPE?	Data Logging Type Query

Table 4-4 Command and Query Summary (cont)

Measurement Rate	
RATE	Select Measurement Rate
RATE?	Measurement Rate Query
Measurement Values	
LAST?	Channel's Last Scan Value
MAX?	Channel's Maximum Value
MIN?	Channel's Minimum Value
NEXT?	Next Scan's Values
Memory Card	
DIR	Memory Card Files Directory
FILE_ERROR?	File Error Query
FILE_LOAD	Configuration File Load
FILE_OPEN	Data File Open
FILE_OPEN?	Data File Open Query
FILE_REMOVE	File Remove
FILE_RX	File Receive
FILE_SPACE?	File Space Query
FILE_STORE	Configuration File Store
FILE_TAG?	File Tag Query
FILE_TX	File Transmit
MCARD?	Memory Card Status Query
MCARD_DIR?	Memory Card Directory Query
MCARD_FORMAT	Memory Card Format
MCARD_SIZE?	Memory Card Size Query
Monitor	
MON	Enable/Disable Monitoring
MON_CHAN?	Monitor Channel Number
MON_VAL?	Monitor Channel Value
Mx+B Scaling	
SCALE_MB	Set Mx+B Scaling Values
SCALE_MB?	Mx+B Scaling Values Query
Operation Complete	
*OPC	Operation Complete
*OPC?	Operation Complete Query

**Table 4-4 Command and Query Summary (cont)**

Remote/Local	
LOCK	Lock/unlock front panel control keys
LOCK?	Returns instrument front panel lock status
LOCS	Local without Lockout
LWLS	Local with Lockout
REMS	Remote without Lockout
RWLS	Remote with Lockout
Reset	
*RST	Reset
Response Format	
FORMAT	Response Format
FORMAT?	Query Response Format
Review Array	
REVIEW_CLR	Clear Review Values
Status Registers	
*CLS	Clear Status
*ESE	Event Status Enable
*ESE?	Event Status Enable Query
*ESR?	Event Status Register Query
IEEE	Instrument Event Enable
IEEE?	Instrument Event Enable Query
IER?	Instrument Event Register Query
*SRE	Service Request Enable Register
*SRE?	Service Request Enable Register Query
*STB?	Read Status Byte Query
Scan	
INTVL	Set Scan Interval
INTVL?	Scan Interval Query
SCAN	Enable/Disable Scanning
SCAN?	Return Scan Status
SCAN_TIME?	Time of Scan
Temperature Options	
TEMP_CONFIG	Temperature Configuration
TEMP_CONFIG?	Temperature Configuration Query

Table 4-4 Command and Query Summary (cont)

Test/Identification	
*IDN?	Identification Query
*TST?	Selftest Query
Time/Date	
DATE	Set Instrument Date
TIME	Set the instrument Time
TIME_DATE?	Retrieve Time and Date
Totalizer	
TOTAL	Set Totalizer Count
TOTAL?	Totalizer Value Query
TOTAL_DBNC	Set Totalizing Debounce
TOTAL_DBNC?	Totalizer Debounce Query
Triggering	
*TRG	Single-Scan Trigger
TRIGGER	Select Trigger Type
TRIGGER?	Trigger Type Query
Wait	
*WAI	Wait-to-Continue

**Table 4-5. Command and Query Reference**

<CNTL><C>	Abort Command
	Stops execution of command
*CLS	Clear Status Clears all event registers (ESR, (IER) summarized in the status byte.
*ESE	Event Status Enable Sets the Event Status Enable Register to the given value.  *ESE <value> <value> = (0 .. 255)  The ESE register is used to enable or mask the output bits of the Standard Event Status Register (ESR). The ANDed output of the ESE and ESR is the Event Status Bit (ESB), which is used as an input for the Status Byte Register. See the previous discussion on status registers for more information.  Example: *ESE 176 [Enables the ESR byte 10110000 (decimal 176), which means the ESB will be set logic high by a Power Transition -or- Command Error -or- Execution Error.]
*ESE?	Event Status Enable Query  Returns an integer representing the present value of the Event Status Enable Register, as selected with the *ESE command. See the previous discussion on status registers for more information.  Example: *ESE? returns 160 [the ESE register is set for 10100000 (decimal 160), which means the Event Status Bit (ESB) will be set logic high by a Power Transition -or- Command Error]
*ESR?	Event Status Register Query  Returns the value of the Standard Event Status Register (ESR) as an integer, then clears the register to 0. See the previous discussion on status registers for more information.  Example: *ESR? returns 48 [The ESR register is set for 00110000 (decimal 48), which means a Command Error and Execution Error were detected since last queried.]

**Table 4-5. Command and Query Reference (cont)**

<p>*IDN?</p>	<p>Identification Query</p> <p>Returns the instrument identification code.</p> <p>The identification code consists of four descriptive fields separated by commas. Note that commas are reserved as field separators and cannot be used within the fields.</p> <table border="1" data-bbox="641 472 1242 640"> <thead> <tr> <th>FIELD</th> <th>DESCRIPTION</th> </tr> </thead> <tbody> <tr> <td>1</td> <td>Manufacturer's name (FLUKE).</td> </tr> <tr> <td>2</td> <td>Instrument model number (2620A or 2625A).</td> </tr> <tr> <td>3</td> <td>0</td> </tr> <tr> <td>4</td> <td>Firmware revision levels.</td> </tr> </tbody> </table> <p>This query must be the last query on the input line, otherwise a query error is generated. It is legal to follow this query with other commands.</p> <p>Example: *IDN? returns FLUKE, 2635A, 0, M6.E A4.7 D1.L1.6 [Fluke product 2645A is running the main software version M6.2, Analog-to-Digital Converter software version A4.7, display software version D1.0, and programmable gate-array version L1.6.]</p>	FIELD	DESCRIPTION	1	Manufacturer's name (FLUKE).	2	Instrument model number (2620A or 2625A).	3	0	4	Firmware revision levels.
FIELD	DESCRIPTION										
1	Manufacturer's name (FLUKE).										
2	Instrument model number (2620A or 2625A).										
3	0										
4	Firmware revision levels.										
<p>*OPC</p>	<p>Operation Complete</p> <p>Causes the instrument to generate an Operation Complete when parsed.</p>										
<p>*OPC?</p>	<p>Operation Complete Query</p> <p>Causes the instrument to place an ASCII 1 in the output queue when parsed.</p>										
<p>*RST</p>	<p>Reset</p> <p>Performs a Configuration Reset. The RS-232 computer interface parameters are not changed, and the temperature unit (°C or °F) is not changed.</p>										
<p>*SRE</p>	<p>Service Request Enable</p> <p>Sets the Service Request Enable Register to the given value.</p> <p>*SRE &lt;value&gt;              &lt;value&gt; = (0 .. 255)</p> <p>The SRE register is used to enable or disable (mask) the output bits of the Status Byte Register (STB). The ORed output of the SRE and STB is the Master Summary Status (MSS) bit, which is used to signal the selected status bits have been set. See the previous discussion on status registers for more information. Note that bit 6 cannot be configured, and bits 1, 2, 3, and 7 are not used.</p> <p>Example: *SRE 49 [Enables the STB byte 00110001 (decimal 49), which means the MSS bit is set logic high by an IEB bit -r-MAV bit -or- ESB bit.]</p>										
<p>*SRE?</p>	<p>Service Request Enable Query</p> <p>Returns the integer value of the Service Request Enable Register (SRE). See the discussion on status registers for more information.</p> <p>Example: *SRE? returns 32 [The SRE register is set for 00100000 (decimal 32), which means the Master Summary Bit will be set logic high when the ESB bit is set logic high.]</p>										



**Table 4-5. Command and Query Reference (cont)**

<b>*STB?</b>	<p>Read Status Byte Query</p> <p>Returns the integer value of the Status Byte, with bit 6 as the master summary bit. See the previous discussion on status registers for more information.</p> <p>Example: *STB returns 97 [The STB register is set for 01100001 (decimal 97), which means the Master Summary Bit, Even Status Bit, and instrument Even Bit are set logic high.]</p>																																										
<b>*TRG</b>	<p>Single- Scan Trigger</p> <p>This command causes the instrument to perform a Single Scan. If a scan is already in progress when this command is parsed, the command is ignored.</p> <p>If logging to memory card is enabled (PRINT_TYPE 3 or 6) and the memory card is missing, full, write-protected, or unformatted, the scan will be performed but an Execution error will be generated.</p>																																										
<b>*TST?</b>	<p>Self Test Query</p> <p>Causes an internal self test to be run, returning the result as an integer (representing the binary encoded value.) The self test does not require any local operator interaction and returns the instrument to the power-up state. The binary coding is:</p> <table style="margin-left: 40px; border-collapse: collapse;"> <thead> <tr> <th style="text-align: left;">Bit</th> <th style="text-align: left;">Binary Value</th> <th style="text-align: left;">Error</th> </tr> </thead> <tbody> <tr><td>0</td><td>1</td><td>Boot ROM Checksum Error1</td></tr> <tr><td>1</td><td>2</td><td>Instrument ROM Checksum Error</td></tr> <tr><td>2</td><td>4</td><td>Internal RAM Test Failed</td></tr> <tr><td>3</td><td>8</td><td>Display Power-Up Test Failed</td></tr> <tr><td>4</td><td>16</td><td>Display Bad or Not Installed</td></tr> <tr><td>5</td><td>32</td><td>Instrument Configuration Corrupted.</td></tr> <tr><td>6</td><td>64</td><td>Instrument Calibration Data Corrupted</td></tr> <tr><td>7</td><td>128</td><td>Instrument Not Calibrated</td></tr> <tr><td>8</td><td>256</td><td>A-to-D Converter Not Responding</td></tr> <tr><td>9</td><td>512</td><td>A-to-D Converter ROM Test Failed</td></tr> <tr><td>10</td><td>1024</td><td>A-to-D Converter RAM Test Failed</td></tr> <tr><td>11</td><td>2048</td><td>A-to-D Converter Self test Failed</td></tr> <tr><td>12</td><td>4096</td><td>Memory Card Interface Not Installed</td></tr> </tbody> </table> <p>Example: *TST? returns 2048 [The A/D self test failed.]</p>	Bit	Binary Value	Error	0	1	Boot ROM Checksum Error1	1	2	Instrument ROM Checksum Error	2	4	Internal RAM Test Failed	3	8	Display Power-Up Test Failed	4	16	Display Bad or Not Installed	5	32	Instrument Configuration Corrupted.	6	64	Instrument Calibration Data Corrupted	7	128	Instrument Not Calibrated	8	256	A-to-D Converter Not Responding	9	512	A-to-D Converter ROM Test Failed	10	1024	A-to-D Converter RAM Test Failed	11	2048	A-to-D Converter Self test Failed	12	4096	Memory Card Interface Not Installed
Bit	Binary Value	Error																																									
0	1	Boot ROM Checksum Error1																																									
1	2	Instrument ROM Checksum Error																																									
2	4	Internal RAM Test Failed																																									
3	8	Display Power-Up Test Failed																																									
4	16	Display Bad or Not Installed																																									
5	32	Instrument Configuration Corrupted.																																									
6	64	Instrument Calibration Data Corrupted																																									
7	128	Instrument Not Calibrated																																									
8	256	A-to-D Converter Not Responding																																									
9	512	A-to-D Converter ROM Test Failed																																									
10	1024	A-to-D Converter RAM Test Failed																																									
11	2048	A-to-D Converter Self test Failed																																									
12	4096	Memory Card Interface Not Installed																																									
<b>*WAI</b>	<p>Wait-to-continue</p> <p>Prevents the parser from executing any more commands or queries until the No-Pending-Operations flag is true. Used in conjunction with *OPC and *OPC?</p>																																										

Table 4-5. Command and Query Reference (cont)

ALARMS?	<p>Active Alarms Query</p> <p>Returns alarm status for a single scanned channel, or alarm status for all scanned channels.</p> <p>ALARMS? &lt;channel&gt;           &lt;channel&gt; = (0 .. 20) or leave blank</p> <p>The values returned represents data from the most recent scan, whether scanning is active or note. The integers returned indicated the alarms condition as follows:</p> <ul style="list-style-type: none"><li>0 neither limit is in alarm and/or alarm(s) not defined</li><li>1 Limit "1" in alarm</li><li>2 Limit "2" in alarm</li><li>3 Limit "1" and Limit "2" in alarm</li></ul> <p>For a single scanned channel, use ALARMS? &lt;channel&gt;. Return data for a single scanned channel consists of a single integer, as defined above. An Execution Error results if a request is made for a channel defined as OFF, the channel specified is invalid, no scan measurements have been made or are being made, or values have been cleared by REVIEW_CLR or by changing any parameter on any channel.</p> <p>For all canned channels, use ALARMS?. Return data for all scanned channels is a string of integers, separated by commas. The first digit represents the alarm status of the lowest channel scanned, and the last digit represents the alarm status of the highest channel scanned.</p> <p>Example: ALARMS? 5 returns 1 [Channel 5 is in Limit 1alarm.]</p> <p>Example: ALARMS? returns 0,2,3,0,1,1, [Six channels were scanned. The first has no alarm or alarms were not defined, the second has a Limit 2 alarm, the third has both Limit 1 and Limit 2 in alarm, the fourth has no alarm or alarms were not defined, the fifth and sixth have a Limit 1 alarm.]</p>
---------	---

**Table 4-5. Command and Query Reference (cont)**

ALARM_ASSOC	<p>Associate Alarm Output</p> <p>Configures alarm output associations at the rear panel DIGITAL I/O connector for channels 4 to 20.</p> <p>ALARM_ASSOC &lt;channel&gt;,&lt;limit_num&gt;,&lt;DO_line&gt;</p> <p>&lt;channel&gt; = (4 .. 20)                  &lt;limit_num&gt; = 1 or 2                  &lt;DO_line&gt; = (0 .. 7)</p> <p>This command is used to associate a channel alarm for channels 4 to 20 with a rear panel DIGITAL I/O line (I/O 0 to I/O 7). Alarm conditions are asserted with a logical low (nominal =0.7V DC); non-alarm conditions are indicated by a logical high (nominal =5.0V DC). The default setting for 4 to 20 are ORed to the I/O lines in groups, as shown below.</p> <table style="margin-left: auto; margin-right: auto; border: none;"> <tr> <td style="padding: 2px 10px;">I/O 4</td> <td style="padding: 2px 10px;">I/O 5</td> <td style="padding: 2px 10px;">I/O 6</td> <td style="padding: 2px 10px;">I/O 7</td> </tr> <tr> <td style="padding: 2px 10px;">Chan</td> <td style="padding: 2px 10px;">Chan</td> <td style="padding: 2px 10px;">Chan</td> <td style="padding: 2px 10px;">Chan</td> </tr> <tr> <td style="padding: 2px 10px;">4</td> <td style="padding: 2px 10px;">5</td> <td style="padding: 2px 10px;">6</td> <td style="padding: 2px 10px;">7</td> </tr> <tr> <td style="padding: 2px 10px;">8</td> <td style="padding: 2px 10px;">9</td> <td style="padding: 2px 10px;">10</td> <td style="padding: 2px 10px;">11</td> </tr> <tr> <td style="padding: 2px 10px;">12</td> <td style="padding: 2px 10px;">13</td> <td style="padding: 2px 10px;">14</td> <td style="padding: 2px 10px;">15</td> </tr> <tr> <td style="padding: 2px 10px;">16</td> <td style="padding: 2px 10px;">17</td> <td style="padding: 2px 10px;">18</td> <td style="padding: 2px 10px;">19</td> </tr> <tr> <td style="padding: 2px 10px;">20</td> <td></td> <td></td> <td></td> </tr> </table> <p>For example, if channel 6 or 10 or 14 or 18 goes into alarm (either Limit 1 or Limit 2), I/O 6 is asserted. This command changes the default settings or any other settings, as desired. Any number of channel alarm limits can be assigned to the same I/O line. For example, all alarms on all channels 4 to 20 could assert a single I/O line. Alarm associations can be returned to the default settings with an *RST configuration reset command. DIGITAL I/O lines set logic low remain low unless values have been cleared by a new alarm association, REVIEW_CLR, or by changing any parameter on any channel. If this command is entered during scanning while logging to the memory card, an Execution Error is generated.</p> <p>Example: ALARM_ASSOC 10,1,2 [For channel 10, alarm Limit 1, assert DIGITAL I/O line 2].</p>	I/O 4	I/O 5	I/O 6	I/O 7	Chan	Chan	Chan	Chan	4	5	6	7	8	9	10	11	12	13	14	15	16	17	18	19	20			
I/O 4	I/O 5	I/O 6	I/O 7																										
Chan	Chan	Chan	Chan																										
4	5	6	7																										
8	9	10	11																										
12	13	14	15																										
16	17	18	19																										
20																													

**Table 4-5. Command and Query Reference (cont)**

ALARM_ASSOC?	<p>Alarm Association Query</p> <p>Returns alarm output associations at the rear panel DIGITAL I/O connector for channels 4 to 20.</p> <p>ALARM_ASSOC?</p> <p>&lt;channel&gt;,&lt;limit_num&gt;</p> <p>&lt;channel&gt; = (4 .. 20)</p> <p>&lt;limit_num&gt; = 1 or 2</p> <p>This command returns an integer that represents the DIGITAL I/O line active at the rear panel DIGITAL I/O connector for the specified channel and alarm limit. If default settings are in effect, returns follow the table below.</p> <table style="margin-left: auto; margin-right: auto; border-collapse: collapse;"> <thead> <tr> <th style="padding: 2px 10px;">I/O 4</th> <th style="padding: 2px 10px;">I/O 5</th> <th style="padding: 2px 10px;">I/O 6</th> <th style="padding: 2px 10px;">I/O 7</th> </tr> <tr> <th style="padding: 2px 10px;">Chan</th> <th style="padding: 2px 10px;">Chan</th> <th style="padding: 2px 10px;">Chan</th> <th style="padding: 2px 10px;">Chan</th> </tr> </thead> <tbody> <tr> <td style="padding: 2px 10px;">4</td> <td style="padding: 2px 10px;">5</td> <td style="padding: 2px 10px;">6</td> <td style="padding: 2px 10px;">7</td> </tr> <tr> <td style="padding: 2px 10px;">8</td> <td style="padding: 2px 10px;">9</td> <td style="padding: 2px 10px;">10</td> <td style="padding: 2px 10px;">11</td> </tr> <tr> <td style="padding: 2px 10px;">12</td> <td style="padding: 2px 10px;">13</td> <td style="padding: 2px 10px;">14</td> <td style="padding: 2px 10px;">15</td> </tr> <tr> <td style="padding: 2px 10px;">16</td> <td style="padding: 2px 10px;">17</td> <td style="padding: 2px 10px;">18</td> <td style="padding: 2px 10px;">19</td> </tr> <tr> <td style="padding: 2px 10px;">20</td> <td></td> <td></td> <td></td> </tr> </tbody> </table> <p>If there is no association between an alarm and DIGITAL I/O line, there is no return and an Execution Error is generated.</p> <p>Example: ALARM_ASSOC? 10,1 returns 2 [For channel 10, alarm Limit 1, will assert DIGITAL I/O line 2].</p>	I/O 4	I/O 5	I/O 6	I/O 7	Chan	Chan	Chan	Chan	4	5	6	7	8	9	10	11	12	13	14	15	16	17	18	19	20			
I/O 4	I/O 5	I/O 6	I/O 7																										
Chan	Chan	Chan	Chan																										
4	5	6	7																										
8	9	10	11																										
12	13	14	15																										
16	17	18	19																										
20																													
ALARM_ASSOC_CLR	<p>Clear Alarm Association</p> <p>Clears an alarm output association at the rear panel DIGITAL I/O connector for channels 4 to 20.</p> <p>ALARM_ASSOC_CLR &lt;channel&gt;,&lt;limit_num&gt;</p> <p style="padding-left: 40px;">&lt;channel&gt; = (4 .. 20)</p> <p style="padding-left: 40px;">&lt;limit_num&gt; = 1 2</p> <p>This command removes all association between a DIGITAL I/O line at the rear panel DIGITAL I/O connector for the specified channels 4 to 20 and alarm limit. After application of this command, the previously associated DIGITAL I/O line is set high and new alarm conditions on this channel's alarm limit will not assert the DIGITAL I/O line. If this command is entered during scanning while logging to the memory card, and Execution Error is generated.</p> <p>Example: ALARM_ASSOC&gt;CLR 10,1 [Channel 10, alarm Limit 1, remove all association with a DIGITAL I/O line.]</p>																												

**Table 4-5. Command and Query Reference (cont)**

<b>ALARM_DO_LEVEL</b>	<p>Alarm Digital Output Level</p> <p>Configures rear panel ALARM OUTPUTS lines for I/O functions.</p> <p>ALARM_DO_LEVEL &lt;DO_line&gt;,&lt;DO_state&gt;              &lt;DO_line&gt; = (0 .. 3)              &lt;DO_state&gt; = 1 (high) 0 (low)</p> <p>The rear panel ALARM OUTPUTS lines 0 to 3 are hard-wired to output alarm conditions for channels 0 to 3, respectively. If all or some of channels 0 to 3 are not configured for alarm outputs, the associated ALARM OUTPUTS line can be assigned to go logic high or low with this command. The line may be set to a logical low. (nominal =0.7V DC), or set to a logical high (nominal =5.0V DC).</p> <p>Example: ALARM_DO_LEVEL 3,0 [Set ALARM OUTPUTS line 3 to a logical 0.]</p>																																																																																					
<b>ALARM_DO_LEVELS?</b>	<p>Alarm Output State Query</p> <p>Returns an integer between 0 and 15 that summarizes the logical state of the rear panel ALARM OUTPUTS lines 0 to 3. Since the lines can be used as alarm outputs or DIGITAL I/O functions, the query represents the actual conditions at time of query. There are 16 possibilities, as shown below (0 = logic low):</p> <table style="margin-left: auto; margin-right: auto; border-collapse: collapse;"> <thead> <tr> <th style="padding: 2px 10px;">Line 3</th> <th style="padding: 2px 10px;">Line 2</th> <th style="padding: 2px 10px;">Line 1</th> <th style="padding: 2px 10px;">Line 0</th> <th style="padding: 2px 10px;">Returned Integer</th> </tr> </thead> <tbody> <tr><td>0</td><td>0</td><td>0</td><td>0</td><td>0 -(all 4 alarms active)</td></tr> <tr><td>0</td><td>0</td><td>0</td><td>1</td><td>1</td></tr> <tr><td>0</td><td>0</td><td>1</td><td>0</td><td>2</td></tr> <tr><td>0</td><td>0</td><td>1</td><td>1</td><td>3</td></tr> <tr><td>0</td><td>1</td><td>0</td><td>0</td><td>4</td></tr> <tr><td>0</td><td>1</td><td>0</td><td>1</td><td>5</td></tr> <tr><td>0</td><td>1</td><td>1</td><td>0</td><td>6</td></tr> <tr><td>0</td><td>1</td><td>1</td><td>1</td><td>7</td></tr> <tr><td>1</td><td>0</td><td>0</td><td>0</td><td>8</td></tr> <tr><td>1</td><td>0</td><td>0</td><td>1</td><td>9</td></tr> <tr><td>1</td><td>0</td><td>1</td><td>0</td><td>10</td></tr> <tr><td>1</td><td>0</td><td>1</td><td>1</td><td>11</td></tr> <tr><td>1</td><td>1</td><td>0</td><td>0</td><td>12</td></tr> <tr><td>1</td><td>1</td><td>0</td><td>1</td><td>13</td></tr> <tr><td>1</td><td>1</td><td>1</td><td>0</td><td>14</td></tr> <tr><td>1</td><td>1</td><td>1</td><td>1</td><td>15 -(no alarms active)</td></tr> </tbody> </table> <p>Example: ALARM_DO_LEVELS? returns 15 [All lines are logic high.]</p>	Line 3	Line 2	Line 1	Line 0	Returned Integer	0	0	0	0	0 -(all 4 alarms active)	0	0	0	1	1	0	0	1	0	2	0	0	1	1	3	0	1	0	0	4	0	1	0	1	5	0	1	1	0	6	0	1	1	1	7	1	0	0	0	8	1	0	0	1	9	1	0	1	0	10	1	0	1	1	11	1	1	0	0	12	1	1	0	1	13	1	1	1	0	14	1	1	1	1	15 -(no alarms active)
Line 3	Line 2	Line 1	Line 0	Returned Integer																																																																																		
0	0	0	0	0 -(all 4 alarms active)																																																																																		
0	0	0	1	1																																																																																		
0	0	1	0	2																																																																																		
0	0	1	1	3																																																																																		
0	1	0	0	4																																																																																		
0	1	0	1	5																																																																																		
0	1	1	0	6																																																																																		
0	1	1	1	7																																																																																		
1	0	0	0	8																																																																																		
1	0	0	1	9																																																																																		
1	0	1	0	10																																																																																		
1	0	1	1	11																																																																																		
1	1	0	0	12																																																																																		
1	1	0	1	13																																																																																		
1	1	1	0	14																																																																																		
1	1	1	1	15 -(no alarms active)																																																																																		

Table 4-5. Command and Query Reference (cont)

<p>ALARM_LIMIT</p>	<p>Alarm Limit</p> <p>Set alarm limit 1 or 2 for any channel 0 to 20.</p> <p>ALARM_LIMIT &lt;channel&gt;,&lt;limit_num&gt;,&lt;sense&gt;,&lt;value&gt;</p> <p style="padding-left: 40px;">&lt;channel&gt; = (0 .. 20)</p> <p style="padding-left: 40px;">&lt;limit_num&gt; = 1 2</p> <p style="padding-left: 40px;">&lt;sense&gt; = HI LO OFF</p> <p style="padding-left: 40px;">&lt;value&gt; = Signed numeric quantity</p> <p>Two alarm limits, Limit 1 and Limit 2, can be assigned to any channel 0 to 20 that is not in the OFF mode. An alarm limit can be used for high alarms, meaning a HI alarm is set if a measurement exceeds the high alarm level, or low alarms, meaning a LO alarm is set if a measurement falls below the low alarm level. If only one of the alarms is used, the other alarms is turned OFF. The alarm value can be any signed number between .00000001 and 9999999, however, the instrument rounds to five significant digits. The signed numeric entries can be entered in scientific notation or as real numbers. If no polarity sign is used, the value is assumed to be positive. Alarm limit settings automatically clear from a channel if the channel function is changed. If Mx+B scaling is applied, alarm settings are based on scaling, i.e., the actual instrument display, if this command is entered during scanning while logging to the memory card, an Execution Error is generated. Setting an alarm limit clears its alarm status and sets any associated ALARM or DIGITAL I/O line high.</p> <p>Example: ALARM_LIMIT 5, 1, LO, -65.872 [For channel 5, configure alarm Limit 1 as a low alarm with a value of -65.872.]</p>
<p>ALARM_LIMIT?</p>	<p>Alarm Limit Assignments Query</p> <p>Return alarm limit 1 or alarm limit 2 for any channel 0 to 20.</p> <p>ALARM_LIMIT? &lt;channel&gt;,&lt;limit_num&gt;</p> <p style="padding-left: 40px;">&lt;channel&gt; = (0 .. 20)</p> <p style="padding-left: 40px;">&lt;limit_num&gt; = 1 2</p> <p>For a selected channel and alarm limit, the returns include the sense of the alarm limit (HI, LO, OFF) plus the value of the alarm setting in scientific notation with five digits of resolution.</p> <p>Example: ALARM_LIMIT? 13, 1 returns LO, -4.5500E+0 [Channel 13, alarm Limit 1 is configured as a low alarm with a value of -4.55.]</p>
<p>*CLS</p>	<p>Clear Status</p> <p>(See front of table.)</p>
<p>DATE</p>	<p>Set Date</p> <p>Set instrument calendar values.</p> <p>DATE &lt;month&gt;,&lt;date&gt;,&lt;year&gt;</p> <p style="padding-left: 40px;">&lt;month&gt; = (1 .. 12)</p> <p style="padding-left: 40px;">&lt;date&gt; = (1 .. 31)</p> <p style="padding-left: 40px;">&lt;year&gt; = (00 .. 99)</p> <p>Invalid values generate an Execution Error.</p> <p>Example: DATE 7,21,94 [Set date for July 21, 1994.]</p>

**Table 4-5. Command and Query Reference (cont)**

<b>DIO_LEVELS?</b>	<p>Digital I/O State Query</p> <p>Returns an integer between 0 and 255 that summarizes the logical state of the rear panel DIGITAL I/O lines 0 to 7. A logical 0 (low) means the line is asserted. Since the lines can be used as alarm outputs of digital inputs or outputs, the return represents the actual conditions at time of query. There are 256 possibilities, as shown in Appendix E.</p> <p>Example: DIO_LEVELS? returns 145 [DIGITAL I/O lines 1, 2, 3, 5 and 6 are asserted (logic low).]</p>
<b>DIR</b>	<p>Memory Card Files Directory</p> <p>Print a formatted listing of files on the memory card. This includes number of files, bytes used, and bytes free. While the directory is printing, all other operations in the instrument are suspended. If hardware or software flow control stall this output, the instrument waits for the output to be unstalled.</p> <p>Example; DIR returns:</p> <pre style="margin-left: 40px;"> DAT00.HYD 826      07-21-1994   16:20 DAT01.HYD 1082     07-21-1994   16:50 SET00.HYD 730      07-21-1994   17:10 SET01.HYD 730      07-21-1994   18:30       4 FILE (S)      3368 BYTES                         1030656 BYTES FREE           </pre>
<b>DO_LEVEL</b>	<p>Set Digital Output Level</p> <p>Configures the eight rear panel DIGITAL I/O connector lines, I/O connector lines, I/O 0 to I/O 7.</p> <p>DO_LEVEL &lt;DO_line&gt;,&lt;DO_state&gt;                    &lt;DO_line&gt;   =   (0 .. 7)                    &lt;DO_state&gt;  =   1 0</p> <p>The rear panel DIGITAL I/O connector has eight lines, 0 to 7. Each line can be assigned to an I/O function. With this command, the line may be set to a logical low (nominal +0.7V DC), or set to a logical high (nominal +5.0V DC). DIGITAL I/O lines are asserted while scanning. When scanning stops, the I/O lines set logic low remain low unless values have been cleared by a new DO_LEVEL command, REVIEW_CLR, or by changing any parameter on any channel. Since I/O lines are shared with the alarm outputs of channels 4 to 20, verify DO_LEVEL commands will not cause ambiguities. (See the ALARM_ASSOC_CLR command to disassociate an alarm with an I/o line.) If this command is entered during scanning while logging to the memory card, an Execution Error is generated.</p> <p>Example: DO_LEVEL 4, 0 [Set I/o line 4 to a logical 0 (low).]</p>

**Table 4-5. Command and Query Reference (cont)**

ECHO	<p>Enable/Disable RS-232 Echo Mode ECHO &lt;1 0&gt; 1 = Turn RS-232 echoing on. 0 = Turn RS-232 echoing off.</p> <p>The echo on mode allows character strings sent from the host to the instrument, to return (echo) back to the host. When operating the instrument from a terminal (or computer in the terminal emulation mode), ECHO 1 is usually selected. If this command is entered during scanning while logging to the memory card, an Execution Error is generated.</p>
*ESE	<p>Event Status Enable (See front of table.)</p>
*ESE?	<p>Event Status Enable Query (See front of table.)</p>
*ESR?	<p>Event Status Enable Query (See front of table.)</p>
FILE_ERROR?	<p>File Error Query</p> <p>Returns an integer number representing the last memory card error that was encountered. Once set, this value is only cleared (set to zero) by performing this query.</p> <p>The possible card error codes are:</p> <p>0 No error since last queried or power up.</p> <p>Card error. No card, invalid file system on card, no file system on card, format operation failed, file could not be removed, and all other I/O errors.</p> <p>Bad file name, or out of file names (all 100 file names of the type being operated on are in used).</p> <p>Card error during scanning, but no data has been lost. Usually occurs when card fills during scanning.</p> <p>Card error during scanning, and data is being lost. The oldest scan data in queue is being lost as each new scan completes.</p>
FILE_LOAD	<p>Configuration File Load Loads the instrument configuration from a memory card configuration or data file.</p> <p>FILE_LOAD &lt;file&gt; &lt;file&gt; = SET00.HYD, SET01.HYD, ... SET99.HYD -or- &lt;file&gt; = DAT00.HYD, DAT01.HYD, ... DAT99.HYD</p> <p>Execution error if the file does not exist, if the file is not an instrument configuration or data file, if the file name is not valid, the card is not installed, or the card is not formatted. An execution error is also generated if either scanning or monitor is active. The file name convention is not checked (a data file may be loaded to recover a configuration). Example: FILE_LOAD SET68.HYD [Loads configuration file SET68.HYD as the new instrument configuration.]</p>



**Table 4-5. Command and Query Reference (cont)**

FILE_OPEN	<p>Data File Open</p> <p>Opens a data file for measurement logging.</p> <p>FILE_OPEN &lt;file&gt;</p> <p style="padding-left: 40px;">&lt;file&gt; = DAT00.HYD, DAT01.HYD, DAT99.HYD</p> <p>All scans are appended to this file until a file close is performed. The special name "*" opens the next available file in sequence. If no higher numbered file can be found, the algorithm "wraps" to zero and keeps searching. If no more file names are available, an Execution Error is generated. If the given file already exists, the file name does not match the convention, or scanning is already active, an Execution Error is generated. Logging is turned on and the card destination activated if this command is successfully executed.</p> <p>Example: FILE_OPEN DAT31.HYD [Open data file DAT31.HYD for data logging.]</p>
FILE_OPEN?	<p>Data File Open Query.</p> <p>Returns the name of the data file to be used for logging, or an Execution Error if no file is open.</p> <p>Example: FILE_OPEN? returns DAT05.HYD [The file DAT05.HYD is open for data logging.]</p>
FILE_REMOVE	<p>File Remove</p> <p>Remove the given file from the memory card.</p> <p>FILE_REMOVE</p> <p style="padding-left: 40px;">&lt;file&gt;</p> <p style="padding-left: 40px;">&lt;file&gt; = DAT00.HYD, DAT01.HYD, ... DAT99.HYD</p> <p style="padding-left: 40px;">or-</p> <p style="padding-left: 40px;">&lt;file&gt; = SET00.HYD, SET01.HYD, ... SET99.HYD</p> <p>Removing the currently open data file will cause any scan data stored in internal memory waiting to be written to the file to be lost.</p> <p>An Execution Error is generated if the file does not exist, the card is write-protected, the file name is invalid, card is not installed or the card is not formatted. The file name convention is not checked.</p> <p>Example: FILE_REMOVE DAT00.HYD [Remove the DAT00.HYD file.]</p>

**Table 4-5. Command and Query Reference (cont)**

<p>FILE_RX</p>	<p>File Receive</p> <p>The normal serial protocol is suspended and a binary transfer (XMODEM) is started between the instrument memory card and the host computer. Received data is typically an instrument configuration file transmitted from the host computer and uses the naming convention, SETxx.HYD. If the file already exists it is overwritten.</p> <p>FILE_RX</p> <p style="padding-left: 40px;">&lt;file&gt; &lt;file&gt; = SET00.HYD, SET01.HYD, ... SET99.HYD</p> <p>An Execution Error is generated under any of the following conditions: the card is not installed; the card is not formatted; the file cannot be created; scan or monitor is active; the instrument is configured for even or odd parity (parity must be "none"); or the instrument is configured for Echo On (Echo must be "Off"). See the FILE_TX command for transmitting data files. The file name convention is not checked, so any file may be transferred to the memory card.</p>
<p>FILE_SPACE?</p>	<p>File Space</p> <p>Returns the number of kilobytes available for files on the memory card.</p> <p>Example: FILE_SPACE? returns 1003 [There are 1003 kilobytes free on the memory card.]</p>
<p>FILE_STORE</p>	<p>Configuration File Store</p> <p>Saves present instrument configuration in the given file.</p> <p>FILE_STORE</p> <p style="padding-left: 40px;">&lt;file&gt; &lt;file&gt; = SET00.HYD, SET01.HYD, ... SET99.HYD</p> <p>Configuration file names must match the naming convention 'SETxx.HYD' where xx is a two-digit integer number. If the given file already exists, it is overwritten. If there is not enough room to store a new configuration file, if the card is write-protected, card is not installed, or card is not formatted, an Execution Error is generated.</p> <p>Example: FILE_STORE SET21.HYD [Save the present instrument configuration in the file SET21.HYD.]</p>

**Table 4-5. Command and Query Reference (cont)**

FILE_TAG?	<p>Configuration File Tag</p> <p>Return the tag from the given configuration or data file (&lt;file&gt; specified), or the present configuration tag (no &lt;file&gt; specified).</p> <p>FILE_TAG?        &lt;file&gt;</p> <p style="padding-left: 40px;">&lt;file&gt;= DAT00.HYD, DAT01.HYD, ... DAT99.HYD</p> <p style="padding-left: 40px;">-or-</p> <p style="padding-left: 40px;">&lt;file&gt; = SET00.HYD, SET01.HYD, ... SET99.HYD</p> <p style="padding-left: 40px;">-or- leave blank</p> <p>Instrument-created configurations use the configuration file name SETxx.HYD for this tag. If no tag has ever been used since the last full reset, or the specified file does not exist, an Execution Error is generated.</p> <p>Example: FILE_TAG? SET17.HYD returns TESTFILE [Present configuration tag in SET17.HYD is the string TESTFILE (set by the user).]</p>
FILE_TX	<p>File Transmit</p> <p>The normal serial protocol is suspended and a binary transfer (XMODEM) is started between the instrument memory card and the host computer. The instrument will transmit a DATxx.HYD file or SETxx.HYD file to the host computer.</p> <p>FILE_TX        &lt;file&gt;</p> <p style="padding-left: 40px;">&lt;file&gt; = DAT00.HYD, DAT01.HYD, ... DAT99.HYD</p> <p style="padding-left: 40px;">-or-</p> <p style="padding-left: 40px;">&lt;file&gt; = SET00.HYD, SET01.HYD, ... SET99.HYD</p> <p>An Execution Error is generated under any of the following conditions: the card is not installed; the card is not formatted; the file does not exist; scan or monitor is active; the instrument is configured for even or odd parity (parity must be "none"); or the instrument is configured for Echo On (Echo must be "Off"). See the FILE_RX command for receiving instrument configuration files. The file name convention is not checked, so any file may be transferred to the memory card.</p>

**Table 4-5. Command and Query Reference (cont)**

<p>FORMAT</p>	<p>Response Format</p> <p>Set the output format type to include or exclude measurement units.</p> <p>FORMAT 1            Measurements returned without units.</p> <p>FORMAT 2            Measurements returned with units.</p> <p>Commands that return measurement data (like LAST?, NEXT?, MIN?, MAX?) can be expressed as a number only (FORMAT 1) or as a number with a measurement unit (FORMAT 2). If this command is entered during scanning while logging to the memory card, an Execution Error is generated. The measurement units are:</p> <table data-bbox="613 625 1062 877"> <thead> <tr> <th>MEASUREMENT</th> <th>UNITS STRING</th> </tr> </thead> <tbody> <tr> <td>Scaled</td> <td>MX+B"</td> </tr> <tr> <td>Volts DC</td> <td>"VDC"</td> </tr> <tr> <td>Volts AC</td> <td>"VAC"</td> </tr> <tr> <td>Resistance</td> <td>"OHMS"</td> </tr> <tr> <td>Frequency</td> <td>"Hz"</td> </tr> <tr> <td>Temperature °C</td> <td>"C"</td> </tr> <tr> <td>Temperature °F</td> <td>"F"</td> </tr> </tbody> </table> <p>With FORMAT 1 asserted, typical returns would be +890.22E+0, +230.96E-3, 072.4E+0, +003.2E; with FORMAT 2 asserted, the returns would be +890.22E+0 HZ, +230.96E-3 VAC, 072.4E+0 F, +003.2E+0 Mx+B.</p>	MEASUREMENT	UNITS STRING	Scaled	MX+B"	Volts DC	"VDC"	Volts AC	"VAC"	Resistance	"OHMS"	Frequency	"Hz"	Temperature °C	"C"	Temperature °F	"F"
MEASUREMENT	UNITS STRING																
Scaled	MX+B"																
Volts DC	"VDC"																
Volts AC	"VAC"																
Resistance	"OHMS"																
Frequency	"Hz"																
Temperature °C	"C"																
Temperature °F	"F"																
<p>FORMAT?</p>	<p>Query Response Format</p> <p>Returns the output format type.</p> <p>1                    Measurements returned without units.</p> <p>2                    Measurements returned with units.</p> <p>Commands that return measurement data (like LAST?, NEXT?, MIN?, MAX?) can be expressed as a number only (FORMAT 1) or as a number with a measurement unit (FORMAT 2). The measurement units are:</p> <table data-bbox="613 1360 1062 1612"> <thead> <tr> <th>MEASUREMENT</th> <th>UNITS STRING</th> </tr> </thead> <tbody> <tr> <td>Scaled</td> <td>MX+B"</td> </tr> <tr> <td>Volts DC</td> <td>"VDC"</td> </tr> <tr> <td>Volts AC</td> <td>"VAC"</td> </tr> <tr> <td>Resistance</td> <td>"OHMS"</td> </tr> <tr> <td>Frequency</td> <td>"Hz"</td> </tr> <tr> <td>Temperature °C</td> <td>"C"</td> </tr> <tr> <td>Temperature °F</td> <td>"F"</td> </tr> </tbody> </table> <p>Example: FORMAT? returns 2 [Measurement data will be returned with a units indicator, e.g., +230.96E-3 VAC.]</p>	MEASUREMENT	UNITS STRING	Scaled	MX+B"	Volts DC	"VDC"	Volts AC	"VAC"	Resistance	"OHMS"	Frequency	"Hz"	Temperature °C	"C"	Temperature °F	"F"
MEASUREMENT	UNITS STRING																
Scaled	MX+B"																
Volts DC	"VDC"																
Volts AC	"VAC"																
Resistance	"OHMS"																
Frequency	"Hz"																
Temperature °C	"C"																
Temperature °F	"F"																

**Table 4-5. Command and Query Reference (cont)**

<b>FUNC</b>	<p>Channel Function Definition</p> <p>Define the Changing a channel configuration automatically erases values held in review, and resets all ALARM OUTPUTS and DIGITAL I/O lines to logical high. The FUNC command clears any alarm limits and scaling values for this channel; therefore, define a channel function before setting alarm limits and/or scaling values for that channel. measurement function and range for the indicated channel.</p> <p>FUNC &lt;channel&gt;, &lt;function&gt;, &lt;range&gt;, &lt;terminals&gt;</p> <p style="margin-left: 20px;">&lt;channel&gt; = 0, 1,2, ...20</p> <p style="margin-left: 20px;">&lt;function&gt; = OFF, VDC, VAC, OHMS, FREQ, TEMP</p> <p style="margin-left: 20px;">&lt;range&gt; = 1,2,3,...6, AUTO [VDC, VAC,OHMS, FREQ]</p> <p style="margin-left: 20px;">&lt;range&gt; = J, K, E, T, N, R, S, B, C [TEMP with thermocouples]</p> <p style="margin-left: 20px;">&lt;range&gt; = PT [TEMP with RTDs]</p> <p style="margin-left: 20px;">&lt;terminals&gt; = 2 or 4</p> <p>Ohms and temperature measurements that use a 4-terminal configuration are limited to channels 1 to 10. Select a channel function, OFF, VDC, VAC, OHMS, FREQ, or TEMP. For voltage, ohms or frequency, select a range 1 to 6, as specified in the table below (or AUTO for autoranging) For temperature, select a thermocouple type, or PT for RTDs.</p> <table style="width: 100%; border-collapse: collapse; margin-top: 10px;"> <thead> <tr> <th style="text-align: left;">RANGE</th> <th style="text-align: left;">VOLTAGE</th> <th style="text-align: left;">OHMS</th> <th style="text-align: left;">FREQUENCY</th> </tr> </thead> <tbody> <tr> <td>1</td> <td>300 mV</td> <td>300 Ω</td> <td>900 HZ</td> </tr> <tr> <td>2</td> <td>3 V</td> <td>3 kΩ</td> <td>9 kHz</td> </tr> <tr> <td>3</td> <td>30 V</td> <td>30 kΩ</td> <td>90 kHz</td> </tr> <tr> <td>4</td> <td>150/300 V*</td> <td>300 kΩ</td> <td>900 kHz</td> </tr> <tr> <td>5</td> <td>90 mV**</td> <td>3 MΩ</td> <td>1 Mhz</td> </tr> <tr> <td>6</td> <td>900 mV**</td> <td>10 MΩ</td> <td></td> </tr> </tbody> </table> <p style="margin-left: 40px;">*300V only on channels 0, 1, and 11</p> <p style="margin-left: 40px;">** Volts DC only</p> <p>The &lt;terminals&gt; selection is specified only when the function type is OHMS, or TEMP using an RTD. The 2-terminal selection is valid on any channel. The 4-terminal selection is valid only for channels 1 to 10 (n), which automatically clears a channel a decade higher (n+10).</p> <p>Example: FUNC 9,TEMP, PT,2 [Set the function of channel 9 to temperature measurements using a Platinum RTD, and the 2-terminal connection.] Example: FUNC 5,VDC,4 [Set the function of channel 5 to volts DC, and use the 150V scale.]</p>	RANGE	VOLTAGE	OHMS	FREQUENCY	1	300 mV	300 Ω	900 HZ	2	3 V	3 kΩ	9 kHz	3	30 V	30 kΩ	90 kHz	4	150/300 V*	300 kΩ	900 kHz	5	90 mV**	3 MΩ	1 Mhz	6	900 mV**	10 MΩ	
RANGE	VOLTAGE	OHMS	FREQUENCY																										
1	300 mV	300 Ω	900 HZ																										
2	3 V	3 kΩ	9 kHz																										
3	30 V	30 kΩ	90 kHz																										
4	150/300 V*	300 kΩ	900 kHz																										
5	90 mV**	3 MΩ	1 Mhz																										
6	900 mV**	10 MΩ																											

**Table 4-5. Command and Query Reference (cont)**

<p>FUNC?</p>	<p>Channel Function Query</p> <p>Return the complete function for the indicated channel.</p> <p>FUNC?            &lt;channel&gt;                     &lt;channel&gt; = (0 .. 20)</p> <p>The returns are in comma-separated data fields using the following format: &lt;function&gt;,&lt;range&gt;,&lt;terminals&gt;</p> <p>The &lt;function&gt; return is OFF, VDC, VAC, OHMS, FREQ, or TEMP. For voltage, ohms, or frequency the &lt;range&gt; return is a number 1 through 6 (see below) or AUTO for autoranging. The &lt;range&gt; return for temperature is a thermocouple type [J, K, E, T, N, R, S, B, C] or PT for RTD measurements. The &lt;terminals&gt; return is for OHMS and TEMP functions only and is either 2 for 2-terminal measurements or 4 for 4-terminal measurements.</p> <p>Example: FUNC? 8 returns TEMP, PT,4 [The function of channel 8 is temperature, using a Platinum resistance-temperature-detector (RTD), and a 4-terminal measurement configuration]</p>
<p>*IDN?</p>	<p>Identification Query</p> <p>(See front of table.)</p>
<p>IEE</p>	<p>Instrument Event Enable</p> <p>Sets the Instrument Event Enable Register to the given value.</p> <p>IEE            &lt;value&gt;                     &lt;value&gt; = (0 .. 255)</p> <p>The IEE register is used to enable or disable (mask) the output bits of the Instrument Event Register (IER). The combined output of the IEE and IER is the Instrument Event Bit (IEB), which is used as an input for the Status Byte Register. See the discussion on status registers for more information.</p> <p>Example: IEE 5 [Enables the IER output byte 00000101 (decimal 5), which means an Open Thermocouple -or- Alarm Limit Transition will set IEB logic high.]</p>
<p>IEE?</p>	<p>Instrument Event Enable Query</p> <p>Returns the present value of the Instrument Event Enable Register as an integer.</p>
<p>IEE?</p>	<p>Instrument Event Register Query</p> <p>Returns the present value of the Instrument Event Enable Register (IEE) as an integer, as selected with the IEE command. See the discussion on status registers for more information.</p> <p>Example: IEE? returns 128 [The IEE register is set for 10000000 (decimal 128), which means a Scan Complete will set IEB logic high.]</p>
<p>IER?</p>	<p>Instrument Event Register Query</p> <p>Returns the value of the Instrument Event Register (IER) as an integer, then clears the register to 0. See the discussion on status registers for more information.</p> <p>Example: IER? returns 133 [The IER register is set for 10000101 (decimal 133), which means a Scan Complete, Open Thermocouple, and Alarm Limit Transition were detected.]</p>

**Table 4-5. Command and Query Reference (cont)**

INTVL	<p>Set Scan Interval</p> <p>Set scan interval time.</p> <p>INTVL      &lt;hours&gt;,&lt;minutes&gt;,&lt;seconds&gt;</p> <p style="padding-left: 40px;">&lt;hours&gt;     = (0 .. 9)</p> <p style="padding-left: 40px;">&lt;minutes&gt; = (0 .. 99)</p> <p style="padding-left: 40px;">&lt;seconds&gt; = (0 .. 99)</p> <p>An Execution Error is generated if values outside the specified ranges are used or if the instrument is scanning.</p> <p>Example: INTVL 1,30,0 [Set the interval time to 1 hour, 30 minutes and 0 seconds.]</p>
INTVL?	<p>Scan Interval Query</p> <p>Return scan interval time. Returns the scan interval time in the format &lt;hours&gt;,&lt;minutes&gt;,&lt;seconds&gt;.</p> <p>Example INTVL? returns 0,0,0 [The interval time is 0 hours, 0 minutes, and 0 seconds (continuous scanning).]</p>
LAST?	<p>Channel's Last Scan Value</p> <p>Returns the last measured value(s) for the scan in progress or the last completed scan.</p> <p>LAST?            &lt;channel&gt;</p> <p style="padding-left: 40px;">&lt;channel&gt; = 0, 1, 2, ... 20</p> <p>Returns last measurement values for either the indicated channel, or for all defined channels if the &lt;channel&gt; field is left blank. An Execution Error results if a request is made for a channel defined as OFF, the channel specified is invalid, the channel specified has been set up but not yet measured, or Review array values have been cleared by REVIEW_CLR, or by changing any parameter on any channel. The returned value is a signed number with decimal point and exponent. For slow scanning rate, 5 digits are returned (+/-XX.XXXE+/-N); for fast scanning rate, 4 digits are returned (+/-XX.XXE+/-N). The channel range setting determines placement of the decimal point. A return of +001.00E+9 indicates an overload (OL) condition; a return of +009.00E+9 indicates an open thermocouple (otc) condition. If no channel specification is made, all the last values of the scanned channels are returned, each separated by a comma.</p> <p>Example: LAST? 1 returns +0074.4E+0 [The last scanned value of channel 1 is 74.4.]</p> <p>Example: LAST? returns +060.14E+0,+013.84E+0,+009.00E+9 [Three channels were scanned. The first channel had a last reading of 60.14; the second channel had a last reading of 13.84; the third channel reading indicates an open thermocouple (RATE 0 and FORMAT 1 are asserted).]</p>

**Table 4-5. Command and Query Reference (cont)**

LOCK	<p>Lock and unlock the instrument front panel control keys. The LOCK modes disable the front panel keys, while placing the instrument in either REVIEW (LOCK 1), MONITOR (LOCK 2) or Configuration Lock (LOCK 3). This limits instrument operation to a specific mode and prevents unauthorized configuration changes. Only supervisory personnel should be aware that the <b>FUNC</b> and <b>Mx+B</b> keys can be used to toggle the LOCK modes on and off, except for LOCK 3, which is reset from the computer interface only or by loading a non-LOCK 3 setup file.</p>
	<p>LOCK modes 1 and 2 are not saved/restored in configuration files. If one of these modes is active when FILE_STORE is performed, mode 0 (unlocked) is stored in the file.</p>
	<p>LOCK            &lt;mode&gt;                   &lt;mode&gt; = 0,1,2,3</p>
LOCK 0	<p>Unlock the front panel and turn off the REM (remote) annunciator. All key functions are enabled. This command is used to clear a LOCK 1, LOCK 2, or LOCK 3 condition.</p>
LOCK 1	<p>Lock the front panel in the REVIEW mode and turn on the REM (remote) annunciator. Only the up/down and left/right arrow keys are unlocked to allow the review of the minimum, maximum, and last values of any channel. The front panel can be unlocked by using the LOCK 0 command, or by simultaneously pressing the front panel <b>FUNC</b> and <b>Mx+B</b> keys. The <b>FUNC</b> and <b>Mx+B</b> keys can be used toggle between the locked and unlocked modes, while in REVIEW.</p>
LOCK 2	<p>Lock the front panel in the MONITOR mode (which must be active or the command will generate an execution error) and turn on the REM (remote) annunciator. Only the up/down arrow keys are unlocked to allow the monitoring of any channel. The front panel can be unlocked by using the LOCK 0 command, or by simultaneously pressing the front panel <b>FUNC</b> and <b>Mx+B</b> keys. The <b>FUNC</b> and <b>□</b> keys can be used to toggle between the locked and unlocked modes, while in MON.</p>
LOCK 3	<p>Lock the channel configuration. The instrument operates normally except keys used to configure a channel are disabled, that is, the configuration is locked. A configuration file can be loaded; scan can be turned on/off, monitor on/off, and review on/off. Exit this mode using the power-up configuration-reset sequenced from the instrument front panel or load a configuration file that has lock-out disabled.</p>
	<p>The four LOCK states are nonvolatile. If power is interrupted, the instrument retains the last LOCK setting.</p>



**Table 4-5. Command and Query Reference (cont)**

LOCK?	<p>Returns the instrument front panel lock status, as selected with the LOCK command.</p> <p>0            Front panel keys are unlocked. All key functions are enabled.</p> <p>1            Front panel keys are locked, except for up/down and left/right arrow keys, which are used to review the minimum, maximum and last values of any channel</p> <p>2            Front panel keys are unlocked, except for the up/down arrow keys, which are used to monitor any channel.</p> <p>3            Front panel keys can be used, except those used to configure a channel.</p>
LOCS	<p>Local without Lockout</p> <p>All front panel keys are enabled, and the REM annunciator is not lit. This is the state assumed by the instrument at power-up reset. To disable all the front panel keys, use the LWLS command.</p>
LOG?	<p>Retrieve Logged Data Query</p> <p>Return the oldest logged scan values for all configured channels and remove them from internal memory (maximum 100 scans). This query is valid during scanning. The remaining count of stored scans (LOG_COUNT? command) is decremented by 1. Channels defined as OFF are not included. If there are no logged scans to remove, an</p> <p>Execution Error is generated.</p> <p>The returns includes the following information:</p> <ul style="list-style-type: none"> <li>• Date and time at the start of the logged scan.</li> <li>• Values for the channels measured.</li> <li>• Status of ALARM OUTPUTS, DIGITAL I/O, and totalize count.</li> </ul> <p>Logging scans in internal memory is enabled by the PRINT and PRINT_TYPE commands.</p> <p>Example: LOG? returns 16,15,30,7,21,94,+034.53E-3 VAC,+09.433E+0 VDC,+1.2043E+6 OHMS,15,255,+00.000E+3 [The oldest recorded scan, that started at 1600 hours, 15 minutes, 30 seconds, on July 21, 1994, measured three channels with readings 34.53mVAC, 9.433 VDC, 1.2043 M OHMS, with ALARM OUTPUTS status 15, DIGITAL I/O status 255, and totalize count of 0 (RATE 0 and FORMAT 2 are asserted).]</p>
LOGGED?	<p>Retrieve specified scan data from internal memory.</p> <p>LOGGED? &lt;index&gt;           &lt;index&gt; = (1,2, 3, .. , 100)</p> <p>A maximum of 100 scans can be recorded in the internal memory. This command is used to retrieve a particular scan. If the &lt;&lt;index&gt;&gt; number has no associated scan, an Execution Error is returned. Logging scans in internal memory is enabled by the PRINT and PRINT_TYPE commands.</p> <p>Scan data is returned in the same format as for the LOG? query.</p>

**Table 4-5. Command and Query Reference (cont)**

LOG_BIN?	<p>Binary Upload of Logged Data</p> <p>Returns a single ASCII string, which encodes the raw binary data stored at the specified &lt;index&gt; position.</p> <p>LOG_BIN?        &lt;index&gt;</p> <p>                  &lt;index&gt; = 1, 2, 3, ... 100</p> <p>See Appendix C for a discussion of the LOG_BIN? command.</p>
LOG_CLR	<p>Clear Logged Scans</p> <p>Clear all stored scan data from internal memory (maximum 100 scans).</p>
LOG_CLR_1	<p>Clear Oldest Logged Scan</p> <p>Clears the oldest (first) scan in the internal memory. If there are no scans in internal memory, an Execution Error is generated. A total of 100 scans can be saved in the log queue.</p>
LOG_COUNT?	<p>Logged Scan Count Query</p> <p>Return the number of stored scans. Returns an integer value representing the number of scans presently stored in memory. (maximum 100) 0 indicates that there are no stored scans.</p> <p>Logging scans in internal memory is enabled by the PRINT and PRINT_TYPE commands.</p> <p>Example: LOG_COUNT? returns 33 [The internal memory holds data from the last 33 scans.]</p>
LOG_MODE	<p>Action when Internal Memory is Full.</p> <p>Determines what action is taken when 100 scans have been recorded</p> <p>LOG_MODE 0        the oldest scans and record new scans.</p> <p>LOG_MODE 1        Maintain the oldest scans and discard new</p> <p>The LOG_MODE setting is nonvolatile and cannot be changed from the instrument front panel. The default is LOG_MODE 0.</p>
LOG_MODE?	<p>Action when Internal Memory is Full Query</p> <p>Returns 0 or 1 to indicate what action will be taken when 100 scans have been recorded</p> <p>0                  Discarding the oldest scans to record new scans.</p> <p>1                  Maintaining the oldest scans and discarding new scans</p>
LWLS	<p>Local with Lockout</p> <p>All front panel keys are disabled. The REM annunciator is not lit. This command can be used when the instrument is scanning or monitoring. To clear, use the LOCS command.</p>

**Table 4-5. Command and Query Reference (cont)**

<b>MAX?</b>	<p>Channel's Maximum Value</p> <p>Returns the maximum value(s) measured since the review array was last cleared. Channel's Maximum Value</p> <p>MAX?            &lt;channel&gt;                   &lt;channel&gt; = 0, 1, 2, ...20, or leave blank</p> <p>Returns maximum measurement values for either the indicated channel, or for all defined channels if the &lt;channel&gt; field is left blank. An Execution Error results if a request is made for a channel defined as OFF, the channel specified is invalid, the channel specified has been set up but not yet measured, or Review array values have been cleared by REVIEW_CLR, or by changing any parameter on any channel. The return is a signed number with decimal point and exponent. For slow scanning rate, 5 digits are returned (+/-XX.XXXE+/-N); for fast scanning rate, 4 digits are returned (+/-XX.XXE+/-N). The channel range setting determines placement of the decimal point. A return of +001.00E+9 indicates an overload (OL) condition; a return of +009.00E+9 indicates an open thermocouple (otc) condition. If no channel specification is made, all the maximum values of the scanned channels are returned, each separated by a comma.</p> <p>Example: MAX? 1 returns +022.34E+0 [The maximum scanned value of channel 1 is 22.34.]</p> <p>Example: MAX? returns +009.00E+9,+890.22E+0,+230.96E-3 [Three channels were scanned. The first channel shows an open thermocouple; the second channel had a maximum reading of 890.22; the third channel had a maximum reading of 0.230 (RATE 0 and FORMAT 1 are asserted).]</p>															
<b>MCARD?</b>	<p>Memory Card Status</p> <p>Returns the memory card status as an encoded integer number from a binary number using bits 0 to 4.</p> <p>Bit 0 - Card changed; remaining bits differ from the last query Bit 1 - A card is present in the unit Bit 2 - Card is write protected Bit 3, 4 - Battery status of last inserted card, as below:</p> <table style="margin-left: 40px; border: none;"> <thead> <tr> <th style="text-align: left;">BIT 4</th> <th style="text-align: left;">BIT 3</th> <th style="text-align: left;">MEMORY CARD BATTERY STATUS</th> </tr> </thead> <tbody> <tr> <td>0</td> <td>0</td> <td>Battery operational</td> </tr> <tr> <td>0</td> <td>1</td> <td>Battery should be replaced; data is OK</td> </tr> <tr> <td>1</td> <td>0</td> <td>Battery and data integrity not guaranteed</td> </tr> <tr> <td>1</td> <td>1</td> <td>Battery and data integrity not guaranteed</td> </tr> </tbody> </table> <p>Example: MCARD? returns 7 [The memory card status is 00111 (decimal 7), meaning the card changed since the last query, a card is in the unit, the card is write protected, and battery is operational.]</p>	BIT 4	BIT 3	MEMORY CARD BATTERY STATUS	0	0	Battery operational	0	1	Battery should be replaced; data is OK	1	0	Battery and data integrity not guaranteed	1	1	Battery and data integrity not guaranteed
BIT 4	BIT 3	MEMORY CARD BATTERY STATUS														
0	0	Battery operational														
0	1	Battery should be replaced; data is OK														
1	0	Battery and data integrity not guaranteed														
1	1	Battery and data integrity not guaranteed														

**Table 4-5. Command and Query Reference (cont)**

<p>MCARD_DIR?</p>	<p>Memory Card Directory</p> <p>Returns a terminated string for each file in the root directory of the memory card. The string is a comma-separated list of the file's name, size, modification date (day, month, year) and time (hours, minutes, seconds).</p> <p>Example: MCARD_DIR? returns:</p> <pre>DAT00.HYD,826,7,21,1994,16,20,44 DAT01.HYD,810,7,21,1994,16,50,10 SET00.HYD,730,7,21,1994,17,10,32 SET01.HYD,730,7,21,1994,18,30,03</pre>
<p>MCARD_FORMAT</p>	<p>Format Memory Card</p> <p>Memory card inserted in the Data Bucket will be formatted. The card must be the static RAM (SRAM) type, meeting PCMCIA standards. An Execution Error is generated and the card not formatted if scanning is in progress, the card is of unknown size, or card is write-protected. If the memory card contains a PCMCIA card information structure (CIS), the card size is determined from the CIS. Otherwise, the size is algorithmically determined by writing to the memory card. A CIS is never written to the card.</p> <p>When formatting a memory card, any scan data that has been stored in internal memory waiting to be written to a valid memory card will be lost.</p>
<p>MCARD_SIZE?</p>	<p>Memory Card Size</p> <p>Returns the memory card size as an integer number of kilobytes.</p> <p>Example: MCARD_SIZE? returns 1024 [Memory card size is 1024 kilobytes (1 megabyte).]</p>
<p>MIN?</p>	<p>Channel's Minimum Value</p> <p>Returns the minimum value(s) measured since the review array was last cleared.</p> <p>MIN?            &lt;channel&gt;&gt;</p> <p>                 &lt;channel&gt; = 0, 1, 2, ... 20, or leave blank</p> <p>Returns minimum measurement values for either the indicated channel, or for all defined channels if the &lt;channel&gt;field is left blank. An Execution Error results if a request is made for a channel defined as OFF, the channel specified is invalid, the channel specified has been set up but not yet measured, or Review array values have been cleared by REVIEW_CLR, or by changing any parameter on any channel.</p> <p>The return is a signed number with decimal point and exponent. For slow scanning rate, 5 digits are returned (+/-XX.XXXE+/-N); for fast scanning rate, 4 digits are returned (+/-XX.XXE+/-N). The channel range setting determines placement of the decimal point. A return of +001.00E+9 indicates an overload (OL) condition; a return of +009.00E+9 indicates an open thermocouple (otc) condition. If no channel specification is made, all the minimum values of the scanned channels are returned, each separated by a comma.</p> <p>Example: MIN? 16 returns +167.85E+3 [The minimum scanned value of channel 16 is 167,850 (RATE 0 and FORMAT 1 are asserted).]</p> <p>Example: MIN? returns +091.67E+0,+001.00E+9,+115.21E-3 [Three channels were scanned. The first channel had a minimum reading of 91.67; the second channel is in overload (OL); the third channel had a minimum reading of 0.11521 (RATE 0 and FORMAT 1 are asserted).]</p>



**Table 4-5. Command and Query Reference (cont)**

<p>NEXT?</p>	<p>Next Scan's Values</p> <p>The NEXT? query returns data values for the next scan to complete. If a scan is in progress when the NEXT? query is processed, the data values returned are from the scan in progress. If a scan is not presently in progress, the NEXT? query waits for data to become available. While waiting, no other commands can be issued. To exit NEXT? while waiting, use &lt;CNTL&gt;&lt;C&gt;.</p> <p>NEXT? returns comma-separated information for the date and time at the start of the next measurement scan, the values for channels measured, the state of the Digital I/O lines, and the totalizer count.</p> <p>The time and date are returned in the following order: Hours (0-23), Minutes (0-59), Seconds (0-59), Month (1-12), Date (1-31), Year (0-99). Measurement data is returned as a list of scientific notation values. For an overload (OL), "+001.00E+9" is returned. If an open thermocouple is detected, "009.00E+9" is returned.</p> <p>ALARM OUTPUTS and DIGITAL I/O values are returned as integer values. (To decode the ALARM OUTPUTS integer, see the ALARM_DO_LEVELS? command; to decode the DIGITAL I/O integer, see the DIO_LEVELS? command. ) The Totalizer value is returned as a scientific notation value.</p> <p>Example: NEXT? returns 16,11,47,7,21,94,+1.0099E+3, +04.556E+0,-13.665E+0,+1.2664E+6,+009.00E+9,15,255, +00.455E+3 [At 1600 hours, 11 minutes, 47 seconds, on July 21, 1994, five channels were scanned with the measurements 1009.9, 4.556, -13.665, 1,266,400, open thermocouple, Alarms I/O status was 15, DIGITAL I/O status was 255, and totalizer count was 455 (RATE 0 and FORMAT 1 are asserted).]</p> <p>Example: NEXT? returns nothing and the computer interface does not accept commands [The NEXT? command was entered when the instrument was not scanning. Press the front panel <b>SCAN</b> key, or enter &lt;CNTL&gt;&lt;C&gt; to clear the NEXT? command.]</p>
<p>*OPC</p>	<p>Operation Complete (See front of table.)</p>
<p>*OPC?</p>	<p>Operation Complete Query (See front of table.)</p>
<p>PRINT</p>	<p>Data Logging Enable/Disable</p> <p>The destination and conditions for data logging are determined by the PRINT_TYPE command, while this command enables or disables the logging of the measurement data.</p> <p>PRINT 0 Disable data logging to memory card and printer</p> <p>PRINT 1 Enable data logging to memory card and printer</p> <p>The PRINT command does not affect the logging of data (100 scans maximum) to the internal memory (log queue), which is always active when selected as a destination (PRINT_TYPE 1,2,5, or 6). If scanning is already active, an Execution Error is generated.</p> <p>When PRINT 1 is asserted, the instrument front panel PRN (Logging) annunciator is on. When PRINT 0 is asserted, the instrument front panel PRN annunciator is off.</p>

**Table 4-5. Command and Query Reference (cont)**

PRINT?	<p>Data Logging Query</p> <p>Returns the status of data logging, as selected with the PRINT command.</p> <p>0    PRINT 0 is selected (data logging disabled)</p> <p>1    PRINT 1 is selected (data logging enabled)</p>
PRINT_TYPE	<p>Set Data Logging Type</p> <p>Set the destination and condition for data logging. When data logging is enabled with the PRINT command, the destination and conditions are set with the PRINT_TYPE command. The &lt;destination&gt; is selected with an integer (0 to 6), and the &lt;type&gt; is selected with an integer (0 to 2). Internal memory is limited to 100 scans. To extract the data from the internal memory, see the LOG? and LOGGED? commands. Attempting to use this command to select a memory card as the logging destination while scanning will cause an Execution Error.</p> <p>PRINT_TYPE            &lt;destination&gt;, &lt;type&gt;</p> <p style="padding-left: 40px;">&lt;destination&gt; = 0, 1, 2, ... 6</p> <p style="padding-left: 40px;">0 = Log data to printer  1 = Log data to log queue  2 = Log data to log queue and printer  3 = Log data to memory card  4 = Log data to memory card and printer  5 = Log data to memory card and log queue  6 = Log data to memory card, log queue, and printer</p> <p style="padding-left: 40px;">&lt;type&gt; = 0, 1 or 2</p> <p style="padding-left: 40px;">0 = Record all scans  1 = Record scans if any scanned channel is in alarm  2 = Record scans when any alarm transitions</p> <p>When the log queue is selected as the destination, all scans are automatically recorded in the log queue as if type 0 was selected. types 1 and 2 are ignored for the log queue, but are still executed for other destinations selected (i.e., the printer and memory card).</p> <p>The PRINT command does not affect the logging of data (100 scans maximum) to the internal memory (log queue), which is always active when selected as a destination (PRINT_TYPE 1,2,5 or 6).</p> <p>Example: PRINT_TYPE 3,1 [When data logging is enabled (see PRINT command), send data to the memory card but only if one of the scanned channels is in alarm.]</p>

**Table 4-5. Command and Query Reference (cont)**

PRINT_TYPE?	<p>Data Logging Type Query</p> <p>Returns the status of data logging destination and condition, as selected with the PRINT_TYPE command. Returns two integers in the form &lt;destination&gt;,&lt;type&gt; as follows:</p> <p style="padding-left: 40px;">&lt;destination&gt; = 0, 1, 2, ... 6</p> <p style="padding-left: 40px;">0 = Log data to printer 1 = Log data to internal memory 2 = Log data to internal memory and printer 3 = Log data to memory card 4 = Log data to memory card and printer 5 = Log data to memory card and internal memory 6 = Log data to memory card, internal memory, and printer</p> <p style="padding-left: 40px;">&lt;type&gt; = 0, 1 or 2</p> <p style="padding-left: 40px;">0 = Record all scans 1 = Record scans if any scanned channel is in alarm 2 = Record scans when any alarm transitions</p> <p>Example: PRINT_TYPE? returns 5,0 [Destination for logged data is to the memory card and internal memory, and all scans are recorded.]</p>																												
RANGE?	<p>Channel Range Query</p> <p>Returns the range(s) used for the scan in progress or the last completed scan. If a channel is configured for autoranging, the actual range used for the measurement is returned.</p> <p>RANGE?            &lt;channel&gt;</p> <p style="padding-left: 40px;">&lt;channel&gt; = 0, 1, 2, ... 20, or leave blank</p> <p>If the &lt;channel&gt; specification field is left blank, values for all defined channels are returned. An Execution Error results if a request is made for a channel defined as OFF, the channel specified is invalid, or if the channel has been set up but not measured with at least one scan. The range value returned is not affected by Mx+B scaling.</p> <p>An integer value (1-6) is returned, based on the table below. Temperature functions (thermocouple and RTD) always return a 1. Commas separate the integers if the return is for all scanned channels.</p> <table style="margin-left: auto; margin-right: auto; border-collapse: collapse;"> <thead> <tr> <th style="text-align: left; padding: 2px;">RANGE</th> <th style="text-align: left; padding: 2px;">VOLTAGE</th> <th style="text-align: left; padding: 2px;">OHMS</th> <th style="text-align: left; padding: 2px;">FREQUENCY</th> </tr> </thead> <tbody> <tr> <td style="padding: 2px;">1</td> <td style="padding: 2px;">300 mV</td> <td style="padding: 2px;">300Ω</td> <td style="padding: 2px;">900 Hz</td> </tr> <tr> <td style="padding: 2px;">2</td> <td style="padding: 2px;">3 V</td> <td style="padding: 2px;">3 kΩ</td> <td style="padding: 2px;">9 kHz</td> </tr> <tr> <td style="padding: 2px;">3</td> <td style="padding: 2px;">30 V</td> <td style="padding: 2px;">30 kΩ</td> <td style="padding: 2px;">90 kHz</td> </tr> <tr> <td style="padding: 2px;">4</td> <td style="padding: 2px;">150/300 V*</td> <td style="padding: 2px;">300 kΩ</td> <td style="padding: 2px;">900 kHz</td> </tr> <tr> <td style="padding: 2px;">5</td> <td style="padding: 2px;">90 mV**</td> <td style="padding: 2px;">3 MΩ</td> <td style="padding: 2px;">1 Mhz</td> </tr> <tr> <td style="padding: 2px;">6</td> <td style="padding: 2px;">900 mV**</td> <td style="padding: 2px;">10 MΩ</td> <td></td> </tr> </tbody> </table> <p style="padding-left: 40px;">*300 V only on channels 0 and 11.</p> <p style="padding-left: 40px;">**Volts DC only.</p> <p>Example: RANGE? 12 returns 3 [Channel 12 has a range of 3. If measuring voltage, it would indicate the 30V scale].</p> <p>Example: RANGE? returns 2,2,1,6 [Four channels were scanned. The first and second have a range of 2, the third a range of 1, and the fourth a range of 6.]</p>	RANGE	VOLTAGE	OHMS	FREQUENCY	1	300 mV	300Ω	900 Hz	2	3 V	3 kΩ	9 kHz	3	30 V	30 kΩ	90 kHz	4	150/300 V*	300 kΩ	900 kHz	5	90 mV**	3 MΩ	1 Mhz	6	900 mV**	10 MΩ	
RANGE	VOLTAGE	OHMS	FREQUENCY																										
1	300 mV	300Ω	900 Hz																										
2	3 V	3 kΩ	9 kHz																										
3	30 V	30 kΩ	90 kHz																										
4	150/300 V*	300 kΩ	900 kHz																										
5	90 mV**	3 MΩ	1 Mhz																										
6	900 mV**	10 MΩ																											



**Table 4-5. Command and Query Reference (cont)**

RATE	<p>Select Measurement Rate</p> <p>Specifies the measurement rate. Changing the measurement rate also clears the Review array, and ALARM OUTPUTS and DIGITAL I/O lines.</p> <p>RATE 0     Selects the slow measurement rate.</p> <p>RATE 1     Selects the fast measurement rate.</p> <p>Selection of the fast measurement rate using the RATE 1 command will speed up the measurement portion of the scan interval; however, the measurement resolution is four digits instead of five digits. For example, a reading of +115.32 with a slow measurement rate would be +115.3 with the fast measurement rate. An Execution Error is generated if the argument is not 0 or 1 or if the instrument is scanning.</p>
RATE?	<p>Measurement Rate Query</p> <p>Return measurement rate for the instrument.</p> <p>0    Measurement rate is slow</p> <p>1    Measurement rate is fast</p>
REMS	<p>Remote without Lockout</p> <p>Places the instrument in the remote mode, lights the front panel REM annunciator, and only two front panel keys are active (with special REMS functionality):</p> <p>The <b>SCAN</b> key triggers a single scan.</p> <p>The <b>SHIFT</b> key returns the instrument to normal front panel control.</p> <p>To return the instrument to normal front panel control with a command, use the LOCS command.</p>
REVIEW_CLR	<p>Clear Review Values</p> <p>Clear all minimum, maximum, and last values (all channels) in the Review array. (It is not possible to selectively clear individual entries in the Review array.) The Review clearing operation is carried out at any time, except during the measurement portion of the scan interval. only at the completion of any scan in progress. Clearing the Review array also clears ALARM OUTPUTS and DIGITAL I/O lines to a logic high..</p>
*RST	<p>Reset</p> <p>(See front of table.)</p>
RTD_R0	<p>RTD Ice Point (R0)</p> <p>For the indicated channel, store the numeric data as the RTD R0 ice point resistance, i.e., the resistance of the RTD at 32°F (0°C). Changing the ice point also clears the Review array and ALARM OUTPUTS and DIGITAL I/O lines. (The 0 portion of R0 in the RTD_R0 command is the number zero.) The default value is 100.00.</p> <p>RTD_R0            &lt;channel&lt;, &lt;R0&gt;</p> <p>                         &lt;channel&gt; = 0,1,2 ... 20</p> <p>                         &lt;R0&gt; = 000.00 to 999.99</p> <p>An Execution Error is generated if the R0 value supplied is not within the indicated range, the channel specified is invalid, the channel is defined as OFF, or measurements are active.</p> <p>Example: RTD_R0 6, 124.85 [For channel 6, set the R0 ice point resistance to a value of 124.85.]</p>

**Table 4-5. Command and Query Reference (cont)**

RTD_R0?	<p>RTD Ice-Point (R0) Query</p> <p>Returns the RTD R0 (ice-point resistance) value for the indicated channel. (The 0 portion of R0 in the RTD_R0 command is the number zero.)</p> <p>RTD_R0?            &lt;channel&gt;</p> <p>                         &lt;channel&lt; = 0,1,2, ... 20</p> <p>If the channel number is invalid, an Execution Error is generated. If a channel is defined OFF, or if no change has been made to R0 for a channel, the value "+100.00E+0" (default) is returned.</p>
RWLS	<p>Remote with Lockout (RS-232 only)</p> <p>Enter the IEEE-488.1 remote with front panel lockout (RWLS) state. All front panel buttons are disabled, and the REM annunciator is lit.</p> <p>If this command is used with the IEEE-488 interface, an Execution Error is generated.</p>

**Table 4-5. Command and Query Reference (cont)**

<b>SCALE_MB</b>	<p>Set Mx+B Scaling Values</p> <p>Set the M and B scaling values for the indicated channel, and display the results of the Mx+B calculation in the indicated display range. Changing the Mx+B of any channel also clears the Review array, and resets ALARM OUTPUTS and DIGITAL I/O lines.</p> <p>SCALE_MB     &lt;channel&gt;,&lt;M_value&gt;,&lt;B_value&gt;,&lt;range&gt;</p> <p style="padding-left: 40px;">&lt;channel&gt; = (0 .. 20)            &lt;M_value&gt; = signed numeric quantity            &lt;B_value&gt; = signed numeric quantity            &lt;range&gt; = (1 .. 16)</p> <p>The range code for the display &lt;range&gt; is shown below</p> <table style="width: 100%; border-collapse: collapse;"> <thead> <tr> <th style="text-align: left;">Range Code</th> <th style="text-align: left;">Display Offset Value</th> <th style="text-align: left;">Max B</th> </tr> </thead> <tbody> <tr><td>1</td><td>0.0000 m</td><td>9.9999E-3</td></tr> <tr><td>2</td><td>00.000 m</td><td>99.999E-3</td></tr> <tr><td>3</td><td>000.00 m</td><td>999.99E-3</td></tr> <tr><td>4</td><td>0000.0 m</td><td>9999.9E-3</td></tr> <tr><td>5</td><td>0.0000 x1</td><td>9.9999</td></tr> <tr><td>6</td><td>00.000 x1</td><td>99.99</td></tr> <tr><td>7</td><td>000.00 x1</td><td>999.99</td></tr> <tr><td>8</td><td>0000.0 x1</td><td>9999.9</td></tr> <tr><td>9</td><td>0.0000k</td><td>9.9999E3</td></tr> <tr><td>10</td><td>00.000k</td><td>99.999E3</td></tr> <tr><td>11</td><td>000.00 k</td><td>999.99E3</td></tr> <tr><td>12</td><td>0000.0 k</td><td>9999.9E3</td></tr> <tr><td>13</td><td>0.0000 M</td><td>9.9999E6</td></tr> <tr><td>14</td><td>00.000 M</td><td>99.999E6</td></tr> <tr><td>15</td><td>000.00 M</td><td>999.99E6</td></tr> <tr><td>16</td><td>0000.0 M</td><td>9999.9E6</td></tr> </tbody> </table> <p>When M=1 and B=0, there is no Mx+B scaling. The entries for M and B must be between +/-0.0001E-3 and +/-9999.9E+6. An Execution Error is generated by invalid entries, a channel set to OFF, if the instrument is scanning, or if the range code is too low for the selected B value. For example, the minimum display range for B=1000 is code 8. Mx+B scaling values for a channel are automatically reset to 1 (M) and 0 (B) when the function for that channel is changed. Returned measurements for a channel with Mx+B scaling has a function identifier of MX+B (when FORMAT 2 has been asserted).</p> <p>Example: SCALE_MB 18,+.55555,-17.777,6 [For channel 18, M=+.55555, B=-17.777, and the display range is 00.000 x1.]</p>	Range Code	Display Offset Value	Max B	1	0.0000 m	9.9999E-3	2	00.000 m	99.999E-3	3	000.00 m	999.99E-3	4	0000.0 m	9999.9E-3	5	0.0000 x1	9.9999	6	00.000 x1	99.99	7	000.00 x1	999.99	8	0000.0 x1	9999.9	9	0.0000k	9.9999E3	10	00.000k	99.999E3	11	000.00 k	999.99E3	12	0000.0 k	9999.9E3	13	0.0000 M	9.9999E6	14	00.000 M	99.999E6	15	000.00 M	999.99E6	16	0000.0 M	9999.9E6
Range Code	Display Offset Value	Max B																																																		
1	0.0000 m	9.9999E-3																																																		
2	00.000 m	99.999E-3																																																		
3	000.00 m	999.99E-3																																																		
4	0000.0 m	9999.9E-3																																																		
5	0.0000 x1	9.9999																																																		
6	00.000 x1	99.99																																																		
7	000.00 x1	999.99																																																		
8	0000.0 x1	9999.9																																																		
9	0.0000k	9.9999E3																																																		
10	00.000k	99.999E3																																																		
11	000.00 k	999.99E3																																																		
12	0000.0 k	9999.9E3																																																		
13	0.0000 M	9.9999E6																																																		
14	00.000 M	99.999E6																																																		
15	000.00 M	999.99E6																																																		
16	0000.0 M	9999.9E6																																																		

Table 4-5. Command and Query Reference (cont)

SCALE_MB?	<p>Mx+B Scaling Values Query</p> <p>Return the M and B scaling values for the indicated channel.</p> <p>SCALE_MB?      &lt;channel&gt;                     &lt;channel&gt; = 0, ... 20</p> <p>This command returns three values. The first two are the M and B values for the channel indicated, even when M=1 and B=0 or the channel function is defined as OFF. These first two values are returned in M and B order and in scientific notation format with five digits of resolution. The third value returned indicates the Mx+B display range. The Mx+B scaling values are automatically reset to 1 (M) and 0 (B) when the function for that channel is changed.</p> <p>The range code for the display &lt;range&gt; is shown below:</p> <table border="1" data-bbox="483 695 899 1283"> <thead> <tr> <th>Range Code</th> <th>Display Offset Value</th> <th>Max B</th> </tr> </thead> <tbody> <tr><td>1</td><td>0.0000 m</td><td>9.9999E-3</td></tr> <tr><td>2</td><td>00.000 m</td><td>99.999E-3</td></tr> <tr><td>3</td><td>000.00 m</td><td>999.99E-3</td></tr> <tr><td>4</td><td>0000.0 m</td><td>9999.9E-3</td></tr> <tr><td>5</td><td>0.0000 x1</td><td>9.9999</td></tr> <tr><td>6</td><td>00.000 x1</td><td>99.99</td></tr> <tr><td>7</td><td>000.00 x1</td><td>999.99</td></tr> <tr><td>8</td><td>0000.0 x1</td><td>9999.9</td></tr> <tr><td>9</td><td>0.0000k</td><td>9.9999E3</td></tr> <tr><td>10</td><td>00.000k</td><td>99.999E3</td></tr> <tr><td>11</td><td>000.00 k</td><td>999.99E3</td></tr> <tr><td>12</td><td>0000.0 k</td><td>9999.9E3</td></tr> <tr><td>13</td><td>0.0000 M</td><td>9.9999E6</td></tr> <tr><td>14</td><td>00.000 M</td><td>99.999E6</td></tr> <tr><td>15</td><td>000.00 M</td><td>999.99E6</td></tr> <tr><td>16</td><td>0000.0 M</td><td>9999.9E6</td></tr> </tbody> </table> <p>Example: SCALE_MB? 0 returns +1.0000E+0,-1.0000E+3,9 [For channel 0, M=1, B=-1000, and the display range is 0.0000 k.]</p>	Range Code	Display Offset Value	Max B	1	0.0000 m	9.9999E-3	2	00.000 m	99.999E-3	3	000.00 m	999.99E-3	4	0000.0 m	9999.9E-3	5	0.0000 x1	9.9999	6	00.000 x1	99.99	7	000.00 x1	999.99	8	0000.0 x1	9999.9	9	0.0000k	9.9999E3	10	00.000k	99.999E3	11	000.00 k	999.99E3	12	0000.0 k	9999.9E3	13	0.0000 M	9.9999E6	14	00.000 M	99.999E6	15	000.00 M	999.99E6	16	0000.0 M	9999.9E6
Range Code	Display Offset Value	Max B																																																		
1	0.0000 m	9.9999E-3																																																		
2	00.000 m	99.999E-3																																																		
3	000.00 m	999.99E-3																																																		
4	0000.0 m	9999.9E-3																																																		
5	0.0000 x1	9.9999																																																		
6	00.000 x1	99.99																																																		
7	000.00 x1	999.99																																																		
8	0000.0 x1	9999.9																																																		
9	0.0000k	9.9999E3																																																		
10	00.000k	99.999E3																																																		
11	000.00 k	999.99E3																																																		
12	0000.0 k	9999.9E3																																																		
13	0.0000 M	9.9999E6																																																		
14	00.000 M	99.999E6																																																		
15	000.00 M	999.99E6																																																		
16	0000.0 M	9999.9E6																																																		
SCAN	<p>Enable/Disable Scanning</p> <p>This command performs the same function as <b>SCAN</b> on the front panel.</p> <p>SCAN 1    Enable scanning. SCAN 0    Disable scanning</p> <p>If SCAN 0 is set during the measurement interval of the scan, the measurement portion is completed. If SCAN 0 is set during the countdown interval of the scan, the scan is immediately terminated.</p> <p>If there are no configured channels (all are defined as OFF) or values other than 0 or 1 are given, an Execution Error is generated.</p> <p>The MON and SCAN commands work in conjunction with the front panel controls. The Monitor and Scan functions can be enabled or disabled from either the front panel or the computer interface. The most recently specified monitor channel (from front panel or computer interface) becomes the one channel monitored.</p> <p>Front panel <b>SCAN</b> and <b>MON</b> buttons work only when the lockout state is "local without lockout" (see the LOCS command)..</p>																																																			



**Table 4-5. Command and Query Reference (cont)**

TEMP_CONFIG?	<p>Temperature Configuration Query</p> <p>Returns the status of the temperature configuration, as selected with the TEMP_CONFIG command. Returns an integer 0, 1, 2, or 3, which corresponds to the temperature configuration, as shown in the table below.</p> <table border="0"> <thead> <tr> <th>Value</th> <th>Meaning</th> </tr> </thead> <tbody> <tr> <td>0</td> <td>OTC Disable and °C</td> </tr> <tr> <td>1</td> <td>OTC Disable and °F</td> </tr> <tr> <td>2</td> <td>OTC Enable and °C</td> </tr> <tr> <td>3</td> <td>OTC Enable and °F</td> </tr> </tbody> </table> <p>Example: TEMP_CONFIG? returns 2 ["otc" detection is enabled and the temperature scale is °C.]</p>	Value	Meaning	0	OTC Disable and °C	1	OTC Disable and °F	2	OTC Enable and °C	3	OTC Enable and °F		
Value	Meaning												
0	OTC Disable and °C												
1	OTC Disable and °F												
2	OTC Enable and °C												
3	OTC Enable and °F												
TIME	<p>Set the instrument time.</p> <p>TIME &lt;hours&gt;,&lt;minutes&gt;</p> <p>&lt;hours&gt; = (0 .. 23) (24-hour scale, 18:00 = 6:00 pm). &lt;minutes&gt; = (0 .. 59) [seconds] = (0, ... 59)</p> <p>Invalid values generate an Execution Error. The [seconds] field can be left blank, automatically entering 00.</p> <p>Example: TIME 16,30,15 [Set the clock for 1600 hours (4 pm), 30 minutes, and 15 seconds.]</p>												
TIME_DATE?	<p>Retrieve Time and Date</p> <p>Returns comma-separated integer values for time, date, and year using the following format:</p> <table border="0"> <tbody> <tr> <td>hours</td> <td>0-23</td> </tr> <tr> <td>minutes</td> <td>0-59</td> </tr> <tr> <td>seconds</td> <td>0-59</td> </tr> <tr> <td>month</td> <td>1-12</td> </tr> <tr> <td>day</td> <td>1-31</td> </tr> <tr> <td>year</td> <td>00-99</td> </tr> </tbody> </table> <p>The TIME command is used to set hours, minutes, and seconds.</p> <p>Example: TIME_DATE? returns 2, 43, 12, 7, 21, 94 [The time is 0200 hours, 43 minutes, 12 seconds, on July 21, 1994]</p>	hours	0-23	minutes	0-59	seconds	0-59	month	1-12	day	1-31	year	00-99
hours	0-23												
minutes	0-59												
seconds	0-59												
month	1-12												
day	1-31												
year	00-99												
TOTAL	<p>Set Totalizer Count</p> <p>Give the Totalizer count a new initial value.</p> <p>TOTAL &lt;t_value&gt;</p> <p>&lt;t_value&gt; = (0 .. 65535)</p> <p>If the value is not in the range 0 through 65,535, an Execution Error is generated. Setting the totalizer count also clears the Totalize Overflow bit in the Instrument Event Register (see Figure 4-3). Clear the Totalizer count by setting the Totalizer to zero (0).</p> <p>Example: TOTAL 12000 [Set the totalizer count to 12000 Clear the Totalizer count by setting the Totalizer to zero (0).</p>												

**Table 4-5. Command and Query Reference (cont)**

TOTAL?	<p>Totalizer Value Query</p> <p>Returns the value of the present Totalizer count. Format of the value is +00.000E+3. When the Totalizer has overflowed, the value returned is +001.00E+9.</p> <p>Example: TOTAL? returns 13.465E+3 [The present value of the totalizer count is 13,465.]</p>
TOTAL_DBNC	<p>Set Totalizing Debounce</p> <p>Set totalizing input debounce state, which adds a delay of 1.75 ms to each transition, allowing increased accuracy from totalizer inputs from contact closures.</p> <p>TOTAL_DBNC    &lt;dbnc_state&gt;                   &lt;dbnc_state&gt; = 1 (on)    0 (off)</p> <p>Use of any other value causes an Execution Error to be generated. At initial power up, totalize debounce is disabled (0). An Execution Error is generated if the totalizer debouhce setting is changed when scanning while logging to the memory card is enabled.</p>
TOTAL_DBNC?	<p>Totalizer Debounce Query</p> <p>Returns the totalizing input's debounce state, as selected with the TOTAL_DBNC command.</p> <p>0    Debounce is off 1    Debounce is on</p>
*TRG	<p>Single-Scan Trigger</p> <p>(See front of table.)</p>
TRIGGER	<p>Select Trigger Type</p> <p>Select the type of scan triggering option. The use of a trigger option has the same effect as pressing the front panel <b>SCAN</b> key. An input for an external trigger is available at the ALARM OUTPUTS connector on the rear panel of the instrument, pins TR and GROUND (TRIGGER 1). Scanning can also be enabled when a monitored channel goes into alarm (TRIGGER 2).</p> <p>TRIGGER 0    External trigger and Alarm trigger disabled TRIGGER 1    External trigger enabled TRIGGER 2    Alarm trigger enabled</p> <p>TRIGGER 0 means external triggering is disabled and only normal scan interval triggering can be used. If this command is entered during scanning while logging to the memory card, an Execution Error is generated.</p> <p>TRIGGER 1 means that external triggering is enabled. An acceptable low input (-0.6 to +0.8V dc) between the pins TR and GROUND on the ALARM OUTPUTS connector on the rear panel will cause the instrument to start scanning. When the TR input returns to logic high, scanning is disabled. External trigger inputs during a scan are ignored.</p> <p>TRIGGER 2 means the alarm trigger is enabled. When a channel being monitored goes into alarm, the instrument starts scanning. When the channel being monitored goes out of alarm, the instrument stops scanning. The *TRG and GET commands can be used with a trigger option selection.</p> <p>If the trigger type given is not one of the listed values, an Execution Error is generated.</p>

**Table 4-5. Command and Query Reference (cont)**

TRIGGER?	Trigger Type Query Returns an integer representing the present trigger type: 0 External trigger and Alarm trigger disabled 1 External trigger enabled 2 Alarm trigger enabled
*TST?	Self Test Query (See front of table.)
*WAI	Wait-to-continue (see front of table)



```

10 ' HYDRALOG.BAS Hydra Program to scan VDC, VAC, OHMS, FREQ or TEMP
20 '           - initializes RS-232 Communications between PC and Hydra
30 '           - configures a number of Hydra channels for one type
40 '           of measurement (e.g., VDC, VAC, temperature, etc.)
50 '           - scan channels 3 times, and display and record measurement
60 '           data in file "TESTDATA.PRN"
70 '
80 ' NOTE: Hydra must be set up for RS-232 communications, 9600 baud,
90 '       no parity, 8 bit data
100 '
110 KEY OFF           ' Switch keyboard event trapping off
120 '
130 ' NOTE: Error message checking is not done here -- QBasic will notify the
140 ' user and exit if there is a problem
150 '
160 ' Open Communications port with 9600 baud, no parity, 8 bit data,
170 '       ignore Clear to Send, Data Set Ready, and Carrier Detect.
180 '
190 OPEN "COM2:9600,N,8,,cs0,ds0,cd0" FOR RANDOM AS #1
200 '
210 '
220 OPEN "testdata.PRN" FOR OUTPUT AS #2   ' Open data file
230 '
240 PRINT #1, "ECHO 0"                   ' Turn off command echo on Hydra
250 '
260 '-----
270 ' Find out the number of channels the user wants to configure
280 ' NOTE: Channel 0 will not be used
290 '
300 NUMCHANNELS = 0
310 WHILE (NUMCHANNELS < 1) OR (NUMCHANNELS > 20)
320     INPUT "Enter the number of channels to be scanned (1-20): ", NUMCHANNELS
330 WEND
340 '
350 'Turn unused channels off
360 PRINT "(Wait...)"
370 '
380 FOR INDEX = (NUMCHANNELS + 1) TO 20
390     PRINT #1, "FUNC " + STR$(INDEX) + ",OFF"
400     GOSUB 1120
410 NEXT INDEX
420 '
430 '
440 'Configure Hydra Channels
450 ' First, initialize screen and display Hydra identification info
460 CLS
470 LOCATE 1, 25: PRINT "Sample Program for Hydra"
480 PRINT #1, "*IDN?": GOSUB 1120: LINE INPUT #1, RESULT$
490 LOCATE 2, 20: PRINT RESULT$
500 '
510 WHILE (1)
520     'Print banner line at bottom of screen
530     LOCATE 25, 1
540     PRINT "1 = VDC   2 = VAC   3 = OHMS   4 = FREQ   5 = TEMP   6 = Quit";
550     ' Get channel configurations
560     FUNC$ = "0"
570     WHILE (FUNC$ < "1") OR (FUNC$ > "6")
580         LOCATE 23, 1: INPUT "                               Selection: ", FUNC$
590     WEND
600     ' Exit and clean up if choice is "Quit"
610     IF FUNC$ = "6" THEN CLOSE 1, 2: CLS : KEY ON: END

```

op51f.eps

**Figure 4-4. Sample Program (GWBasic) (1 of 2)**

```

620 '
630 ' Set up the common channel configuration string (function and range)
640 IF (FUNC$ = "1") THEN CONFIG$ = "VDC, 1"
650 IF (FUNC$ = "2") THEN CONFIG$ = "VAC, 1"
660 IF (FUNC$ = "3") THEN CONFIG$ = "OHMS, 1, 2" ' Assuming 2-terminal channel
670 IF (FUNC$ = "4") THEN CONFIG$ = "FREQ, 1"
680 IF (FUNC$ = "1") THEN CONFIG$ = "TEMP, K" ' Assuming K thermocouple
690 '
700 'Set up Hydra / Configure channels
710 LOCATE 23, 1: PRINT "Programming Hydra...";
720 FOR INDEX = 1 TO NUMCHANNELS
730     PRINT #1, "FUNC " + STR$(INDEX) + "," + CONFIG$
740     GOSUB 1120
750 NEXT INDEX
760 '
770 LOCATE 23, 1: PRINT "Measuring " + CONFIG$ + " "
780 '
790 ' Scan three times
800 FOR INDEX = 1 TO 3
810     PRINT #1, "*TRG" ' Start a single scan
820     GOSUB 1120 ' Get prompt back from Hydra
830     PRINT #1, "SCAN_TIME?": GOSUB 1120
840     LINE INPUT #1, RESULT$ ' Get scan time stamp
850     PRINT #2, RESULT$ ' Save time stamp to data file
860     FOR CHANNELINDEX = 1 TO NUMCHANNELS ' Get scan data
870         PRINT #1, "LAST? " + STR$(CHANNELINDEX) ' Request channel data
880         GOSUB 1120
890         INPUT #1, RESULT$ ' Get channel result
900         LOCATE CHANNELINDEX + 2, 25
910         PRINT "Chan " + STR$(CHANNELINDEX) + ": ";
920         PRINT RESULT$ ' Print results to screen
930         PRINT #2, RESULT$ + ","; ' Print results to data file
940     NEXT CHANNELINDEX
950     PRINT #2, "" ' End of line to data file
960 NEXT INDEX
970 WEND
980 END
990 '
1000 '
1010 '
1020 '
1030 ' CHECKRESPONSE Subroutine
1040 ' This subroutine checks the Hydra prompt after sending a command to
1050 ' Hydra, to see if an error occurred
1060 '
1070 ' The possible responses are:
1080 '     "=>(CR)(LF)" (command successful)
1090 '     "?>(CR)(LF)" (command syntax error)
1100 '     "!>(CR)(LF)" (command execution error)
1110 '
1120 PROMPT$ = INPUT$(4, #1) ' Get prompt
1130 IF INSTR(1, PROMPT$, "=>") <> 0 THEN RETURN 'Command successful
1140 IF INSTR(1, PROMPT$, "?>") <> 0 THEN
1150     PRINT "Command Syntax Error!"
1160 ELSEIF INSTR(1, PROMPT$, "!>") <> 0 THEN
1170     PRINT "Command Execution Error!"
1180 END IF
1190 '
1200 PRINT "Program execution halted due to communications errors"
1210 END

```

op51\_1f.eps

Figure 4-5. Sample Program (GW BASIC) (2 of 2)

```

' HYDRALOG.BAS  Hydra Program to scan VDC, VAC, OHMS, FREQ or TEMP
'               - initializes RS-232 Communications between PC and Hydra
'               - configures a number of Hydra channels for one type
'               of measurement (e.g., VDC, VAC, temperature, etc.)
'               - scan channels 3 times, and display and record measurement
'               data in file "TESTDATA.PRN"

' NOTE: Hydra must be set up for RS-232 communications, 9600 baud,
'       no parity, 8 bit data

KEY OFF          ' Switch keyboard event trapping off

' NOTE: Error message checking is not done here -- QBasic will notify the
'       user and exit if there is a problem

' Open Communications port with 9600 baud, no parity, 8 bit data,
'       ignore Clear to Send, Data Set Ready, and Carrier Detect.

OPEN "COM2:9600,N,8,,cs0,ds0,cd0" FOR RANDOM AS #1

OPEN "testdata.PRN" FOR OUTPUT AS #2      ' Open data file

PRINT #1, "ECHO 0"                        ' Turn off command echo on Hydra

'-----
' Find out the number of channels the user wants to configure
' NOTE: Channel 0 will not be used

NumChannels = 0
WHILE (NumChannels < 1) OR (NumChannels > 20)
    INPUT "Enter the number of channels to be scanned (1-20): ", NumChannels
WEND

'Turn unused channels off
PRINT "(Wait...)"

FOR Index = (NumChannels + 1) TO 20
    PRINT #1, "FUNC " + STR$(Index) + ",OFF"
    GOSUB CheckResponse
NEXT Index
    
```

**Figure 4-5. Sample Program (QBASIC) (1 of 3)**

op52\_1f.eps

```

'Configure Hydra Channels
' First, initialize screen and display Hydra identification info
CLS
LOCATE 1, 25: PRINT "Sample Program for Hydra"
PRINT #1, "*IDN?": GOSUB CheckResponse: LINE INPUT #1, Result$
LOCATE 2, 20: PRINT Result$

WHILE (1)
  'Print banner line at bottom of screen
  LOCATE 25, 1
  PRINT "1 = VDC    2 = VAC    3 = OHMS    4 = FREQ    5 = TEMP    6 = Quit";
  ' Get channel configurations
  Func$ = "0"
  WHILE (Func$ < "1") OR (Func$ > "6")
    LOCATE 23, 1: INPUT "                Selection: ", Func$
  WEND
  ' Exit and clean up if choice is "Quit"
  IF Func$ = "6" THEN CLOSE 1, 2: CLS : KEY ON: END

  ' Set up the common channel configuration string (function and range)
  SELECT CASE Func$
    CASE "1"
      Config$ = "VDC, 1"
    CASE "2"
      Config$ = "VAC, 1"
    CASE "3"
      Config$ = "OHMS, 1, 2" ' Assuming 2-terminal channel
    CASE "4"
      Config$ = "FREQ, 1"
    CASE "5"
      Config$ = "TEMP, K"    ' Assuming K thermocouple
  END SELECT

  'Set up Hydra / Configure channels
  LOCATE 23, 1: PRINT "Programming Hydra...";
  FOR Index = 1 TO NumChannels
    PRINT #1, "FUNC " + STR$(Index) + ", " + Config$
    GOSUB CheckResponse
  NEXT Index

  LOCATE 23, 1: PRINT "Measuring " + Config$ + " "

  ' Scan three times
  FOR Index = 1 TO 3
    PRINT #1, "**TRG"                ' Start a single scan
    GOSUB CheckResponse              ' Get prompt back from Hydra
    PRINT #1, "SCAN_TIME?": GOSUB CheckResponse
    LINE INPUT #1, Result$           ' Get scan time stamp
    PRINT #2, Result$                ' Save time stamp to data file
    FOR ChannelIndex = 1 TO NumChannels ' Get scan data
      PRINT #1, "LAST? " + STR$(ChannelIndex) ' Request channel data
      GOSUB CheckResponse
      INPUT #1, Result$                ' Get channel result
      LOCATE ChannelIndex + 2, 25
      PRINT "Chan " + STR$(ChannelIndex) + ": ";
      PRINT Result$                   ' Print results to screen
      PRINT #2, Result$ + ", ";       ' Print results to data
    NEXT ChannelIndex
    PRINT #2, ""                      ' End of line to data file
  NEXT Index
WEND
END

```

op52\_2f.eps

Figure 4-6. Sample Program (QBASIC)(2 of 3)

```

CheckResponse:
' CHECKRESPONSE Subroutine
' This subroutine checks the Hydra prompt after sending a command to
' Hydra, to see if an error occurred

' The possible responses are:
'     "=>(CR)(LF)"      (command successful)
'     "?>(CR)(LF)"      (command syntax error)
'     "!>(CR)(LF)"      (command execution error)

PROMPT$ = INPUT$(4, #1)           ' Get prompt
IF INSTR(1, PROMPT$, "=>") <> 0 THEN RETURN 'Command successful
IF INSTR(1, PROMPT$, "?>") <> 0 THEN
    PRINT "Command Syntax Error!"
ELSEIF INSTR(1, PROMPT$, "!>") <> 0 THEN
    PRINT "Command Execution Error!"
END IF

PRINT "Program execution halted due to communications errors"
END
    
```

op52\_3f.eps

**Figure 4-6. Sample Program (QBASIC) (3 of 3)**

```
/*
 * HYDRALOG.C   Hydra Program to scan VDC, VAC, OHMS, FREQ or TEMP
 *              - initializes RS-232 Communications between PC and Hydra
 *              - configures a number of Hydra channels for one type
 *                of measurement (e.g., VDC, VAC, temperature, etc.)
 *              - scan channels 3 times, and display and record measurement
 *                data on the screen and in file "testdata.prn"
 *
 * This program uses routines from the GreenLeaf Communications Library
 * (asiopen(), asiputs(), and asigetstimed()) for sending and receiving
 * information from the serial port connected to the Hydra. We recommend
 * the use of a third-party serial communications library when developing
 * C programs to communicate with Hydra instruments over PC serial ports.
 */

/*
 * NOTE: Hydra must be set up for RS-232 communications, 1200 baud,
 *       no parity, 8 bit data
 */

#include <stdio.h>
#include <string.h>
#include <errno.h>

#include "asiports.h"          /* Greenleaf CommLib include file */

static FILE *testdata;       /* File handle for output data file */

main(argc,argv)
int argc;
char *argv[];
{
    int ret_code;             /* code returned by various GreenLeaf
                               communications functions */

    unsigned numChannels;    /* Number of channels to be scanned */
    unsigned index;          /* counter */

    char response[30];        /* Buffer for user response */
    char sendbuff[129];       /* local buffer for transmitting to Hydra */
    char recvbuff[129];       /* local buffer for receiving from Hydra */

    /* Open and initialize COM2, the serial port the Hydra unit is attached
       to, for 1200 baud, no parity, 8 bit data, and ignore DTR and CTS */

    ret_code = asiopen( COM2, (ASINOUT | BINARY | NORMALRX), 1000, 1000,
                        1200L, P_NONE, 1,8,FALSE,FALSE );
    if ( ret_code < ASSUCCESS ) {
        fprintf(stderr,"Failed to open the port, Greenleaf error: %d.\n",
                ret_code );
        exit(1);
    }

    /*send reset and uninstall */
    asiputc (com2, '\x11');
    asiputc (com2, '\x03');
    checkResponse ();          /* Get prompt */
}
```

Figure 4-6. Sample Program (QuickC) (1of 5)

op53\_1f.eps

```

asiputs( COM2, "ECHO 0", -2); /* Turn off command echo on Hydra */
checkResponse();           /* Get prompt */

/* Open data file TESTDATA.PRN */
if((testdata = fopen("testdata.prn","w")) == NULL)
{
    perror("Cannot open testdata.prn");
    exit(1);
}

/* Find out the number of channels the user wants to configure
   NOTE: Channel 0 will not be used */

numChannels = 0;
while((numChannels < 1) || (numChannels > 20))
{
    fprintf(stdout,"Enter the number of channels to be scanned (1-20):");
    gets(response);
    numChannels = atoi(response); /* convert ascii response to numeric */
}

/* Turn off unused channels */
fprintf(stdout,"\nWait...\n");
for(index = numChannels + 1; index < 21; ++index)
{
    sprintf(sendbuff,"FUNC %d, OFF",index);
    asiputs(COM2,sendbuff,-2);
    checkResponse(); /* get prompt */
}

/* Print Header and Hydra identification header */

fprintf(stdout,"\n\nSample Program for Hydra\n");

asiputs(COM2,"*IDN?",-2); /* Ask for Hydra identification info */
checkResponse(); /* Get prompt */
asigetns_timed(COM2,recvbuff,256,-2,TICKS_PER_SECOND*2); /* Receive Hydra
                                                         identification
                                                         header */

fprintf(stdout,"%s\n\n",recvbuff);

/*
 * Configure channels and scan until user chooses to Quit
 */

while(1)
{
    int func; /* Configuration setting */
    char configStr[14]; /* channel function string */

    /*
     * Configure Hydra Channels
     */

```

op53\_2f.eps

**Figure 4-7. Sample Program (QuickC) (2 of 5)**

```
/* Request channel configuration from user */
fprintf(stdout,"1 = VDC\t\t2 = FAC\t\t3 = OHMS\t4 = FREQ\t5 =
TEMP\t\t6 = Quit\n");

func = 0;
do
{
    fprintf(stdout," Selection (1-6): ");
    gets(response);
    func = atoi(response);
} while((func < 1) || (func > 6));

if(func == 6)          /* If Quit, exit program */
    break;

switch(func)
{
    /* set configuration string */
case 1:
    strcpy(configStr,"VDC,1");
    break;
case 2:
    strcpy(configStr,"VAC,1");
    break;
case 3:
    strcpy(configStr,"OHMS,1,2"); /* Assuming 2-terminal channel */
    break;
case 4:
    strcpy(configStr,"FREQ,1, 1");
    break;
case 5:
    strcpy(configStr,"TEMP, K"); /* Assuming K thermocouple */
    break;
}

/* Send configuration to Hydra */
fprintf(stdout,"Programming Hydra...\n");
for(index = 1;index <= numChannels;++index)
{
    sprintf(sendbuff,"FUNC %d,%s",index,configStr);
    asiputs(COM2,sendbuff,-2);
    checkResponse(); /* get prompt */
}
}
```

Figure 4-7. Sample Program (QuickC) (3 of 5)

op53\_3f.eps



```

/*
 * Scan and receive data
 */

fprintf(stdout, "\nMeasuring %s...\n", configStr);

for(index=0;index < 3;++index)
{
    /* scan three times */
    unsigned chanIndex; /* Channel counter */

    asiputs(COM2,"*TRG",-2); /* trigger scan */
    checkResponse(); /* get prompt */

    asiputs(COM2,"SCAN_TIME?",-2); /* request time stamp for scan */
    checkResponse(); /* get prompt */

    /* receive time stamp for scan, and write to
    data file */
    asigetst_timed(COM2,rcvbuff,256,-2,TICKS_PER_SECOND*2);
    fprintf(testdata,"%s\n",rcvbuff);

    for(chanIndex = 1; chanIndex <= numChannels; ++chanIndex)
    {
        /* get value scanned for each channel */
        sprintf(sendbuff,"LAST? %d",chanIndex);
        asiputs(COM2,sendbuff,-2); /* request value for channel */
        checkResponse(); /* get prompt */

        /* receive value for channel and write to
        screen and data file */
        asigetst_timed(COM2,rcvbuff,256,-2,TICKS_PER_SECOND*2);
        fprintf(stdout,"Chan %d: %s, ",chanIndex,rcvbuff);
        fprintf(testdata,"%s, ",rcvbuff);
    }
    fprintf(stdout,"\n");
    fprintf(testdata,"\n");
}
fprintf(stdout,"\n");
fprintf(testdata,"\n");
}

fclose(testdata);
exit(0);
}

```

Figure 4-7. Sample Program (QuickC)(4 of 5)

op53\_4f.eps

```
/*
 * This function checks the Hydra prompt after sending a command to Hydra,
 * to see if an error occurred.
 *
 * Possible responses are:
 *     "=>(CR)(LF)"      (Command successful)
 *     "?>(CR)(LF)"      (Command syntax error)
 *     "!>(CR)(LF)"      (Command execution error)
 */

static int checkResponse()
{
    char response[129];

    /* Gets string from Hydra -- asigets_timed
     gets characters from the receive buffer,
     and strips the (CR)(LF) characters from
     the end before placing them in the
     "response" buffer */
    asigets_timed(COM2,response,128,-2,TICKS_PER_SECOND*2);

    /* check to see if the command worked correctly */
    if(strcmp(response,"=>") == 0)
        return 0;          /* command executed without error */

    if(strcmp(response,"?>") == 0)
        fprintf(stderr,"Command Syntax Error!\n");
    else
    {
        if(strcmp(response,"!>") == 0)
            fprintf(stderr,"Command Execution Error!\n");
    }

    fprintf(stderr,"\nProgram execution halted due to communications errors\n");
    fclose(testdata);
    exit(1);
}
```

Figure 4-7. Sample Program (QuickC)(5 of 5)

op53\_5f.eps

# **Chapter 5**

## **Printer Operations**

<b>Title</b>	<b>Page</b>
Summary of Printer Operations.....	5-3
Connecting the Instrument to a Printer.....	5-3
Configuring for Printer Operations .....	5-5
Printing Measurement Data and Memory Card Directory .....	5-6
Problems?.....	5-6
Printing Measurement Results During Scanning .....	5-6
Printing the Review Array .....	5-8
Printing the Directory of the Memory Card.....	5-9

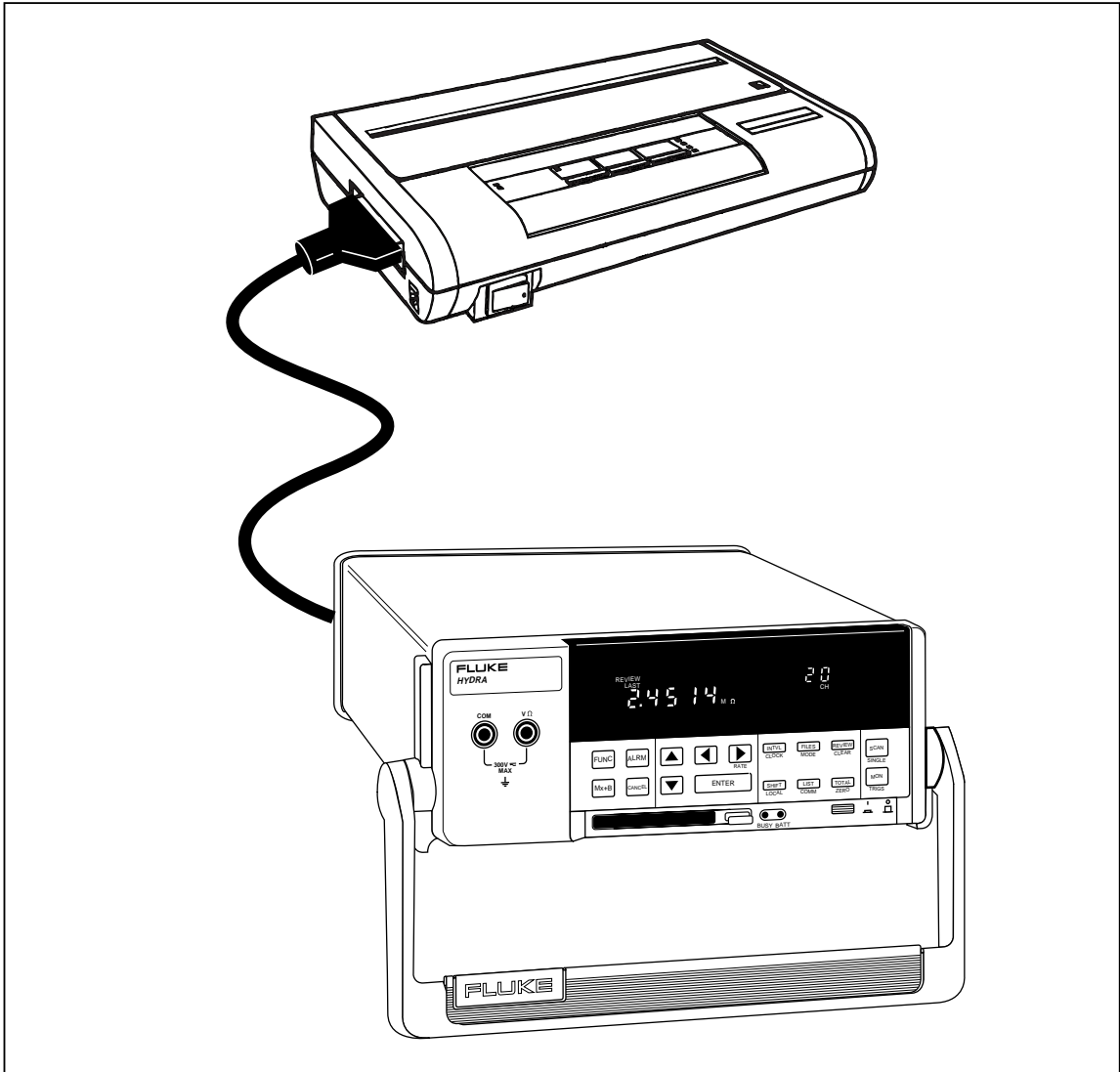

op83f.eps

## **Summary of Printer Operations**

Printer operations allow an RS-232 connection between the instrument and a printer to print out measurement results during scanning, the Review array, and a directory of the memory card files. The printer must accept a serial data input, either directly or via a serial-to-parallel converter. Measurement data recorded onto the memory card cannot be printed out from the instrument (see Memory Card Operations, Chapter 3). The information in this chapter is provided in three parts:

- Connecting the Instrument to a Printer
- Configuring for Printer Operations
- Printing Measurement Data and Memory Card Directory

## **Connecting the Instrument to a Printer**

The two most common configurations for connecting the instrument to a printer are shown in Figure 5-1. Printers with an RS-232 serial data interface may be used directly, while printers with a parallel input require a serial-to-parallel converter. For other configurations, refer to your printer manual. A complete discussion of RS-232 connections and cables, including cable fabrication information, is provided in Appendix D.

### *Note*

*Several printers use cables that have a DB-25 connector at one end. This does not necessarily indicate connectivity with the instrument RS-232 port. Examples include parallel interface printer cables, and 8-pin mini-circular cables. Check your printer manual before making any connections if there is doubt about the interface.*

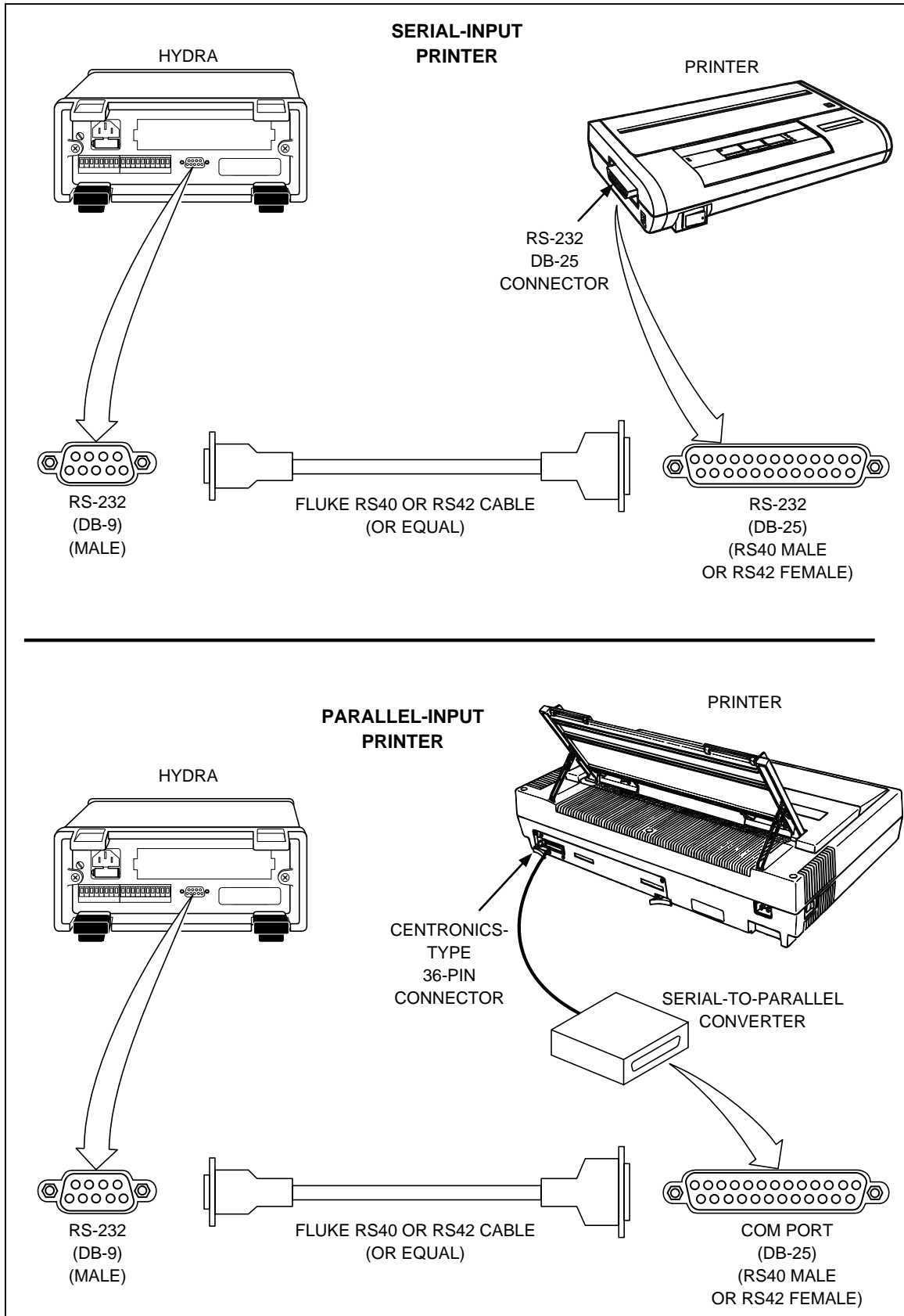

Figure 5-1. Connecting the Instrument to a Printer

op54f.eps

## Configuring for Printer Operations

Correct operation of the instrument RS-232 link with a printer depends on the link parameters baud rate, parity, and CTS (Clear To Send). Perform the procedure in Figure 5-3 to establish communication link parameters. Refer to your printer manual for information on selecting identical parameters for the printer, usually through the setting of DIP (dual in-line package) switches (with the printer unpowered). The instrument uses a fixed one start bit and one stop bit.

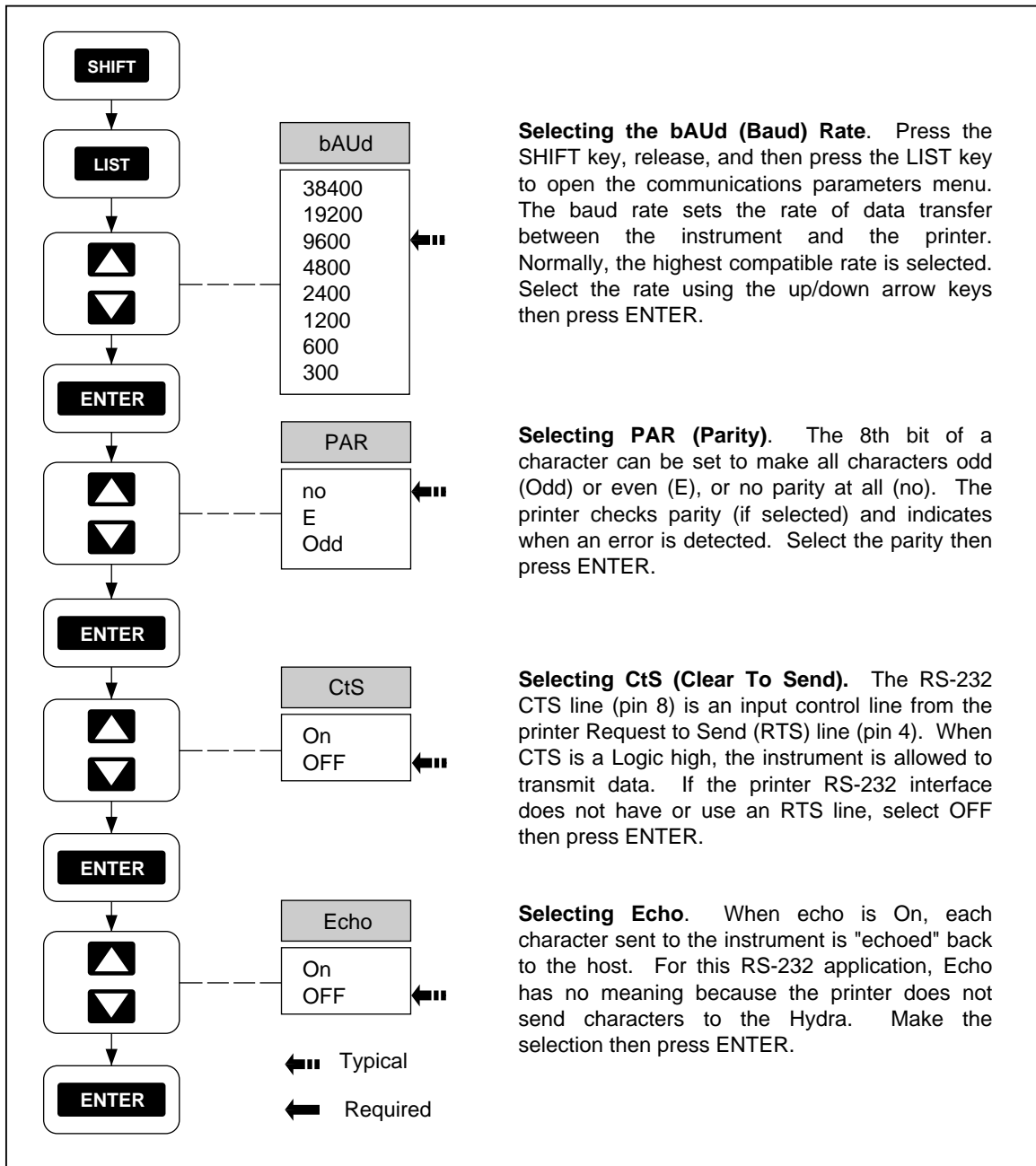

Figure 5-2. Configuring the RS-232 Ports for Print Operations

op55f.eps

## ***Printing Measurement Data and Memory Card Directory***

An RS-232 link between the instrument and a printer allows printing of the following data:

- Printing Measurement Results During Scanning (Figure 5-3)
- Printing the Review Array (Figure 5-4)
- Printing the Memory Card Directory(Figure 5-5)

The following procedures describe the operation of this link. Before continuing, verify the instrument and the printer have been properly connected (Figure 5-1), and configured for operation (Figure 5-2).

### ***Problems?***

If the printer does not operate after the RS-232 connection has been made and the instrument and printer RS-232 parameters have been set, check the following:

1. No characters. No operation of any kind usually indicates a cabling problem, hardware incompatibility (e.g., connecting to a printer with a parallel input), or the printer is not on-line and ready for operation (ribbon, paper, power, interlocks, etc.).
2. Incorrect characters. Incorrect printer function (rapid paper feeds, wrong characters) usually indicates a configuration incompatibility, i.e., the instrument and printer baud rate and parity don't match.
3. Missed characters. The Data Bucket Hydra Series II RS-232 port is different from the RS-232 port on the Data Acquisition Hydra Series II (Model 2620A) and Data Logger Hydra Series II (Model 2625A), because of the addition of three modem control lines, CTS, RTS, and DSR (see Appendix D). If the printer occasionally loses characters, the printer may need to control the data flow from the instrument. Try enabling CTS "on" to see if this solves the problem.

### ***Printing Measurement Results During Scanning***

Perform the procedure in Figure 5-3 to print measurement results during scanning. The destination for the scanned data can be the printer, memory card, both the printer and the memory card, or no destination, where the data is saved only in the Review array. The mode for the printing to the printer or memory card can be all scanned data, scanned data only when any scanned channel is in alarm, or scanned data only when an alarm transitions from one alarm stat to another.



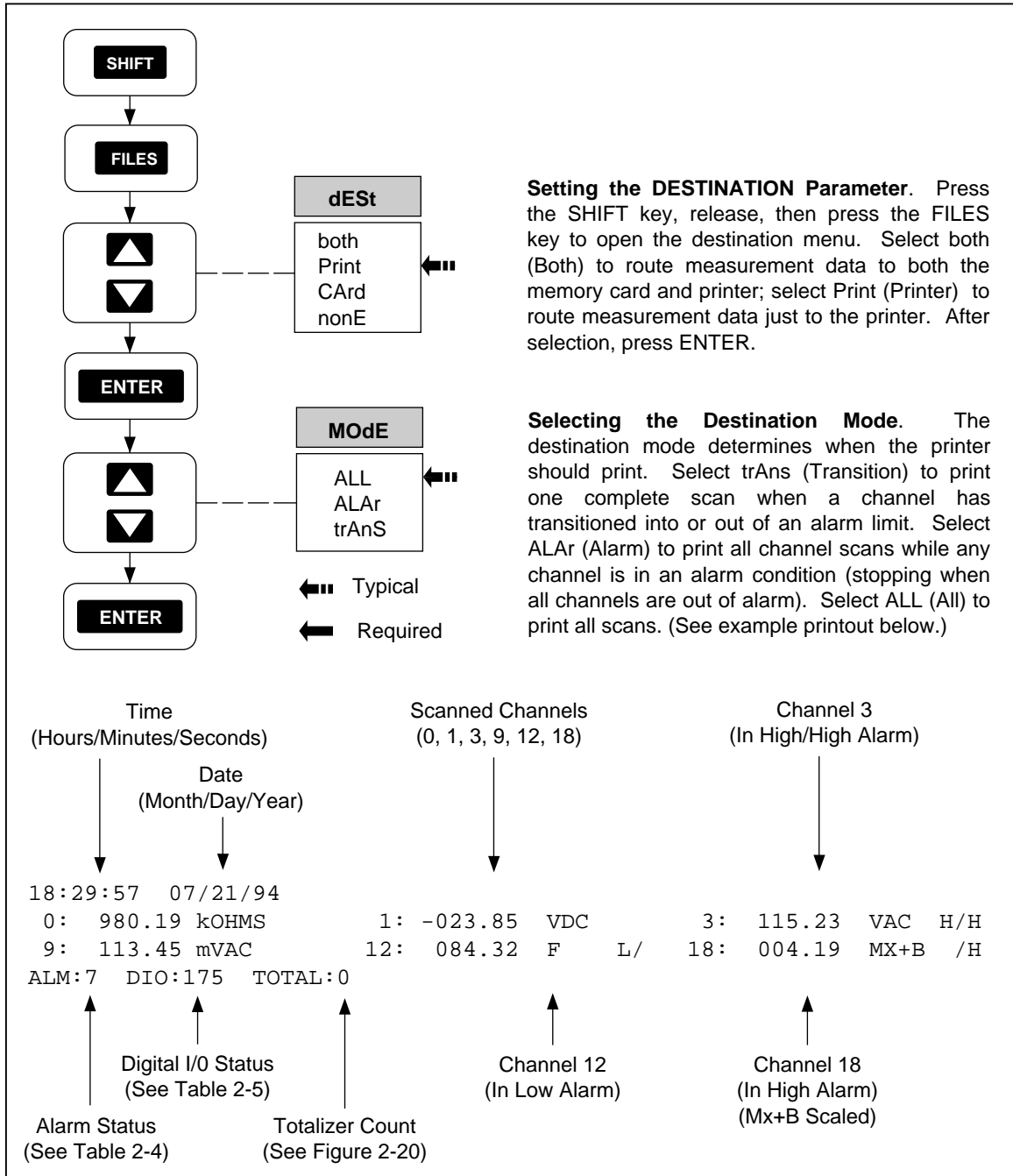

Figure 5-3. Printing Measurement Results During Scanning

op56f.eps

### Printing the Review Array

Perform the procedure in Figure 5-4 to print the Review array, which consists of the last, maximum, and minimum measurement values during the last scan, and previous scans if the instrument configuration has not changed or the review array cleared. If the Review array is blank (cleared), an error message is displayed with an audible "beep." If this occurs, press **CANCL** to exit the menu.

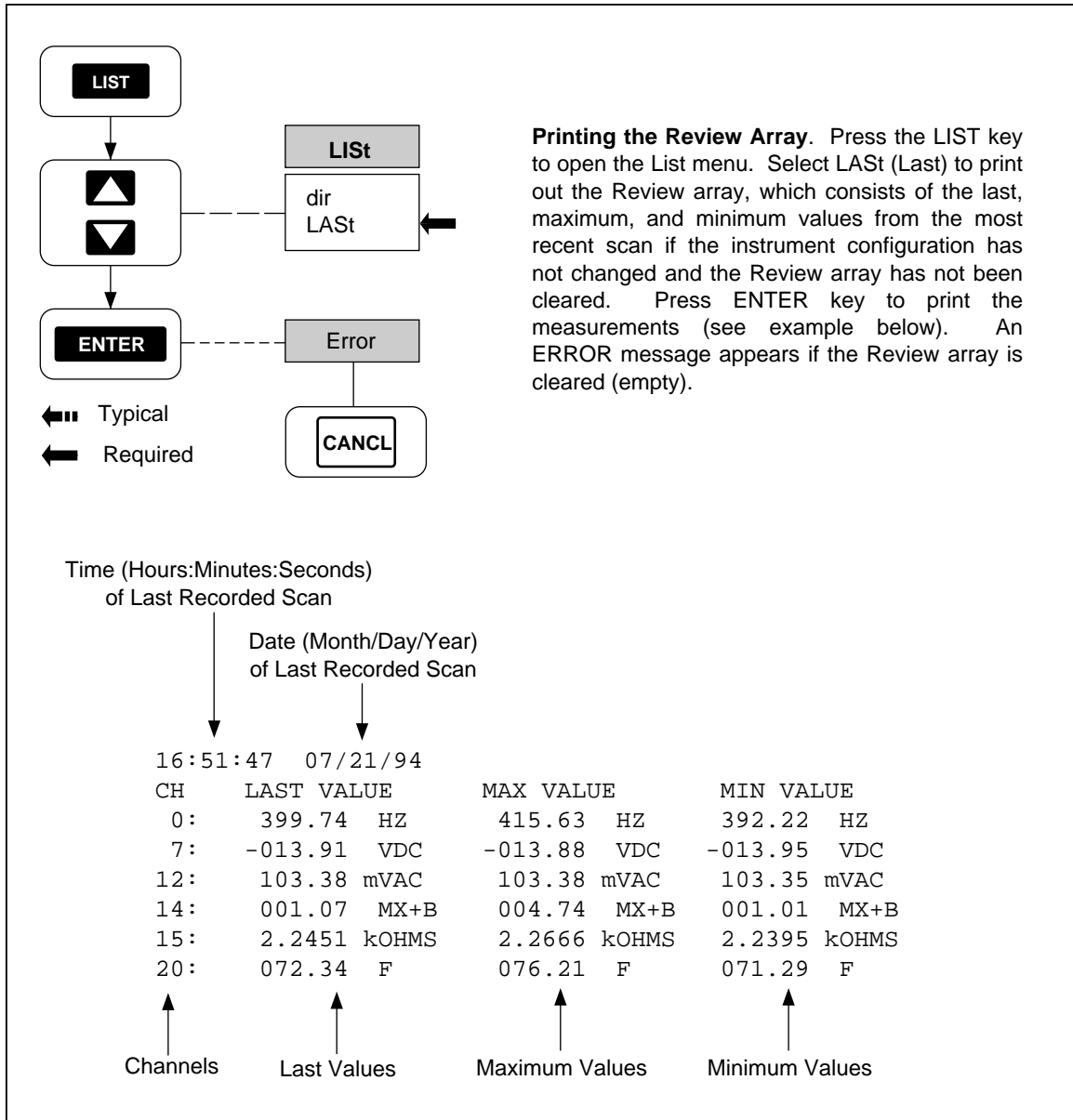
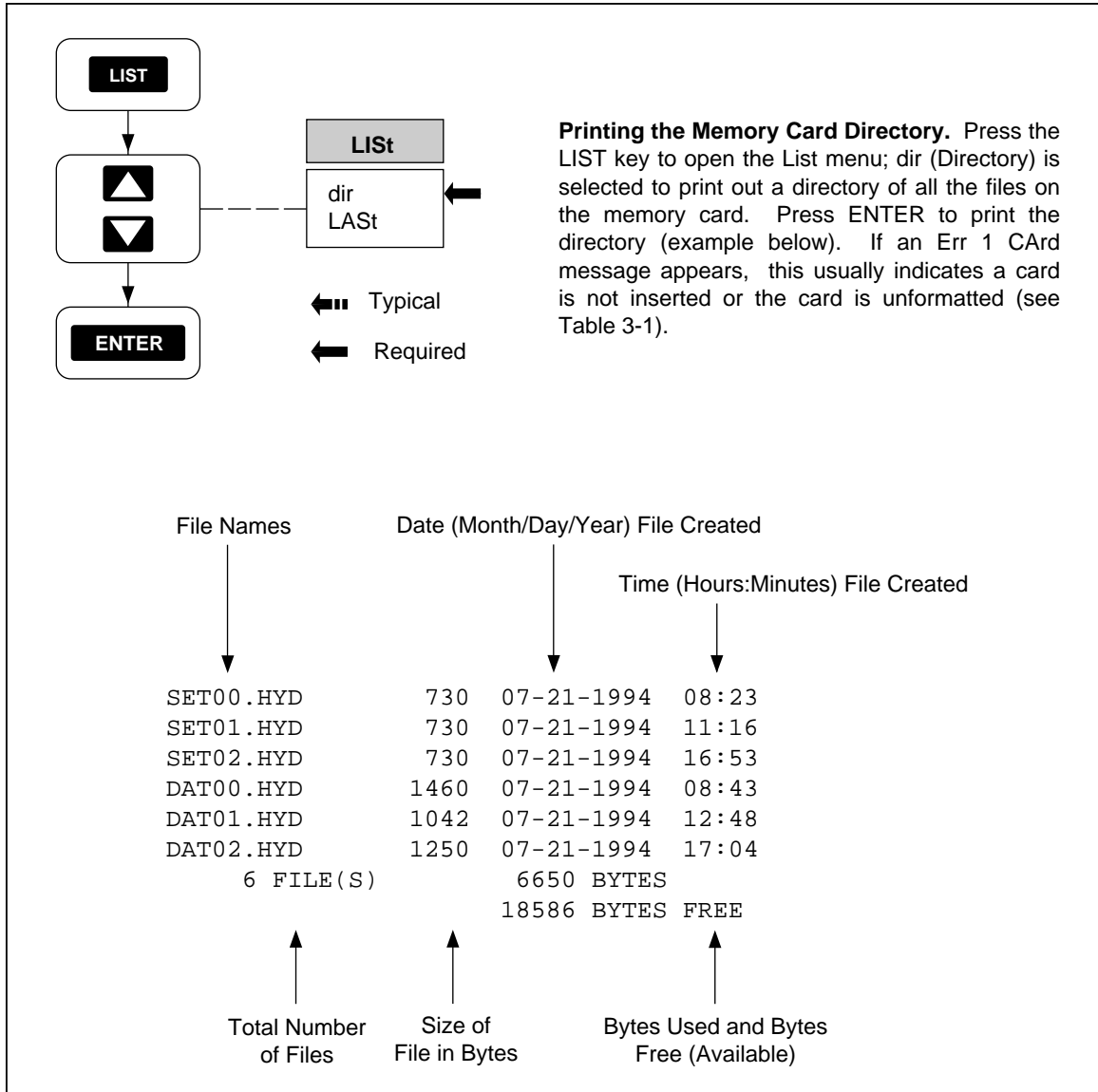

Figure 5-4. Printing the Review Array

op57f.eps

**Printing the Directory of the Memory Card**

Perform the procedure in Figure 5-5 to print the directory of the memory card files. The format is similar to a PC directory for a disk drive and will print any files that exist on the memory card.



**Figure 5-5. Printing the Memory Card Directory**

op58f.eps



# **Chapter 6**

## ***Modem Operations***

<b>Title</b>	<b>Page</b>
Summary of Modem Operations .....	6-3
Connecting the Modem to a PC for Modem Configuration .....	6-4
Configuring the Instrument Modem for Modem Operations .....	6-4
Connecting the Modem to an Instrument .....	6-6
Configuring the Instrument for Modem Operations.....	6-7
Testing the RS-232/Modem Interface .....	6-8

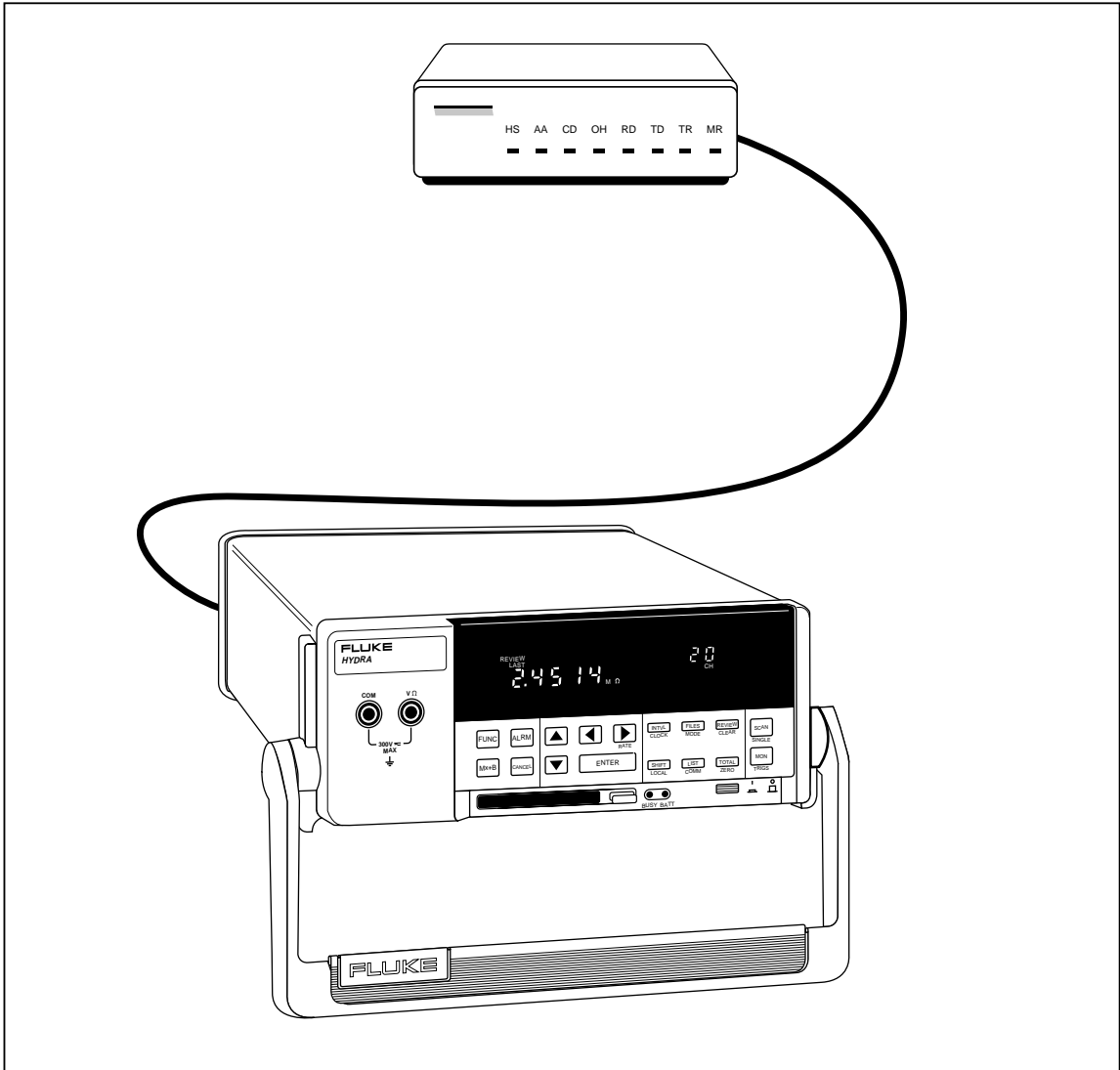

op84f.eps

## Summary of Modem Operations

Modem operations allow an RS-232 connection between an instrument and a PC via modems and telephone lines, instead of a direct RS-232 connection as described in Chapter 4, "Computer Operations." Due to the wide variety of modems available and their corresponding software, only the most common connection using a Hayes-compatible modem using the AT command set is described. This connection can be adapted to any configuration, following the basic rules in each procedure. A typical overall connection diagram is shown in Figure 6-1.

Hayes-compatible modems are both configured and controlled by commands from a PC. Since the Data Bucket does not have the capability to configure a modem, the modem is configured using a PC, then the PC is removed and the modem is connected to the Data Bucket. The modem operates in a simple answer mode since calls are never originated from the instrument. The modem configuration is stored in the modem memory. Some modems use an internal battery to prevent the erasure of the configuration if the modem power switch is turned off, while others lose all configuration when the power is turned off. Check the manual for your modem for an understanding of how the configuration is maintained.

The information in this chapter is provided in five parts:

- Connecting the Modem to a PC for Configuration
- Configuring the Modem for Modem Operations
- Connecting the Modem to an Instrument
- Configuring the Instrument for Modem Operations
- Testing the RS-232/Modem Interface

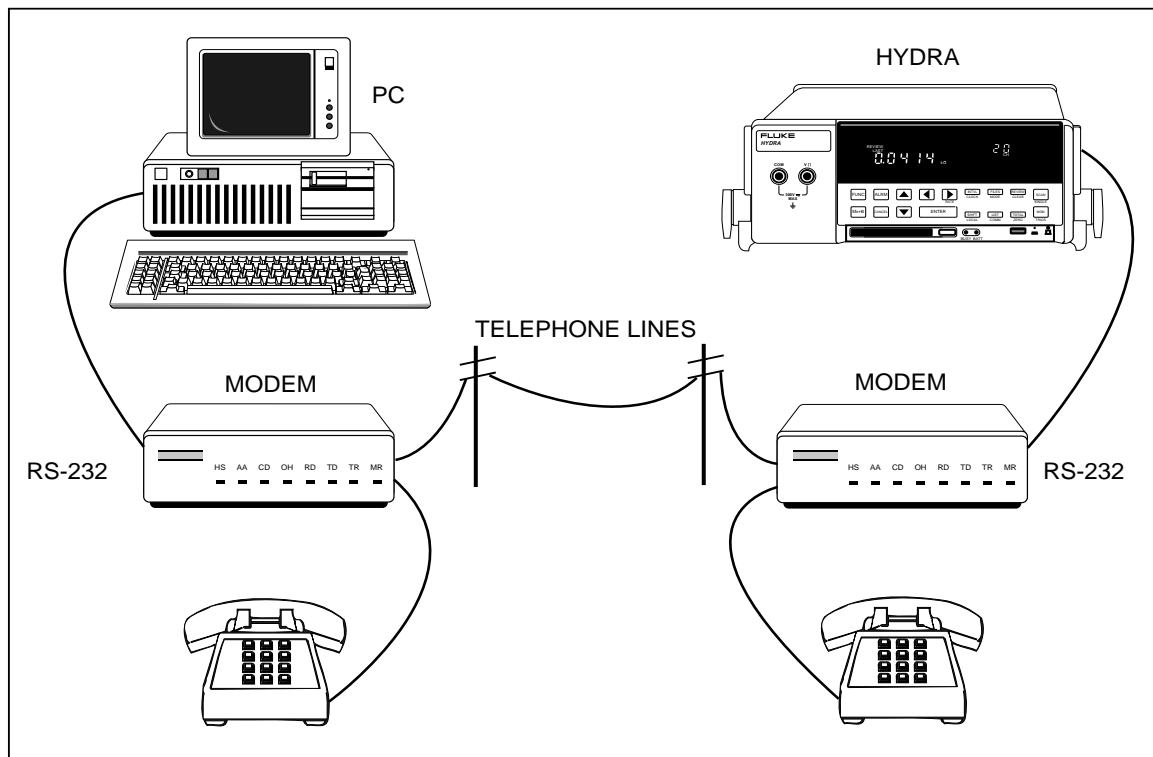

Figure 6-1. Overall PC-to-Instrument Modem Connection

op59f.eps

## **Connecting the Modem to a PC for Modem Configuration**

The two most common configurations for connecting the modem to a PC are shown in Figure 6-2. The modem RS-232 port (DB-25 connector) is cabled to a PC serial COM port that uses either a DB-9 connector or DB-25 connector. The connecting cable can be fabricated (See Appendix D) or ordered from Fluke as an option (see Chapter 1).

## **Configuring the Instrument Modem for Modem Operations**

Commands to configure the modem are sent from the PC that is running communications software. The example below uses the Terminal mode that is available on any PC that is running Windows software. Modem operation at 2400 baud is assumed for this procedure, which should be adapted, as required.

1. Start Windows and open TERMINAL on the ACCESSORIES menu.
2. Open the SETTINGS menu and select COMMUNICATIONS.
3. In COMMUNICATIONS, select the following, then use OK to exit to TERMINAL:  
Connector COM 1 [Typical]  
Baud Rate 2400  
Data Bits 8  
Stop Bits 1  
ParityNone  
Flow Control None
4. In TERMINAL, enter a few AT <ENTER> character sequences. If the cable connection is correct and the modem has LED indicators, the data send and data receive indicator will blink. If LED blinking is not observed, check the cabling and verify that the correct PC COM port was selected in step 3.
5. Enter the command ATV1 <ENTER>, which gives result codes in English, instead of numbers. For example, the AT <ENTER> characters entered in the last step would display the result code OK.
6. Enter the command ATS0=1 <ENTER>, which configures the modem to answer calls after one ring. [The 0 character of the S0 portion of the command is the number zero.]Observe the result code OK.
7. This completes the software configuration of the modem. Check all modem DIP switches for proper settings. In particular, some modems have a NO ANSWER switch that must be disabled or the modem will not answer calls. Be sure the modem remains powered or the configuration data could be lost. Refer to your modem manual, as required.



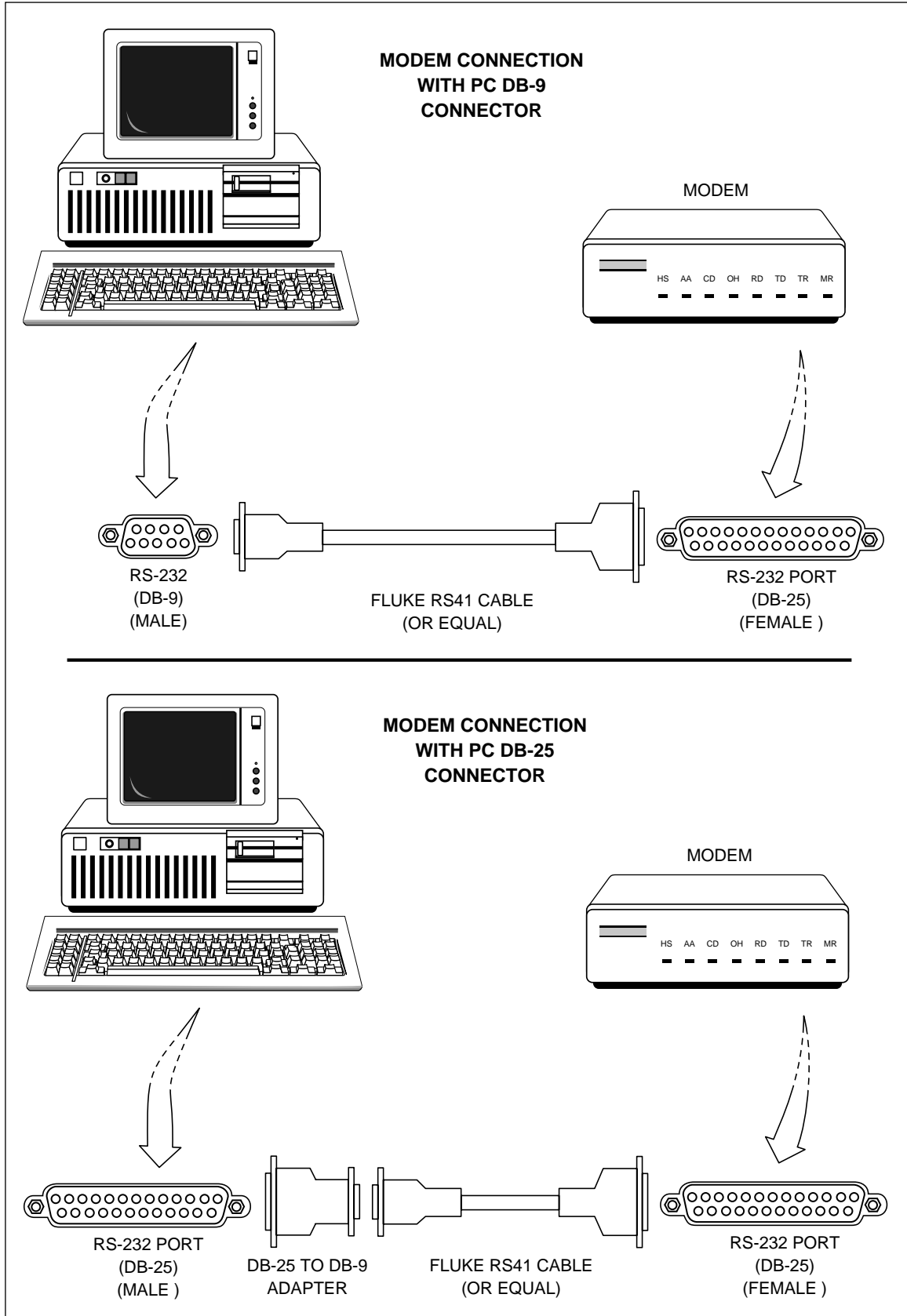

op60f.eps

Figure 6-2. Connecting the Modem to a PC

## Connecting the Modem to an Instrument

Remove the cable from the PC and connect to the Data Bucket, as shown in Figure 6-3. If a different cable is used, be sure it is a modem cable.

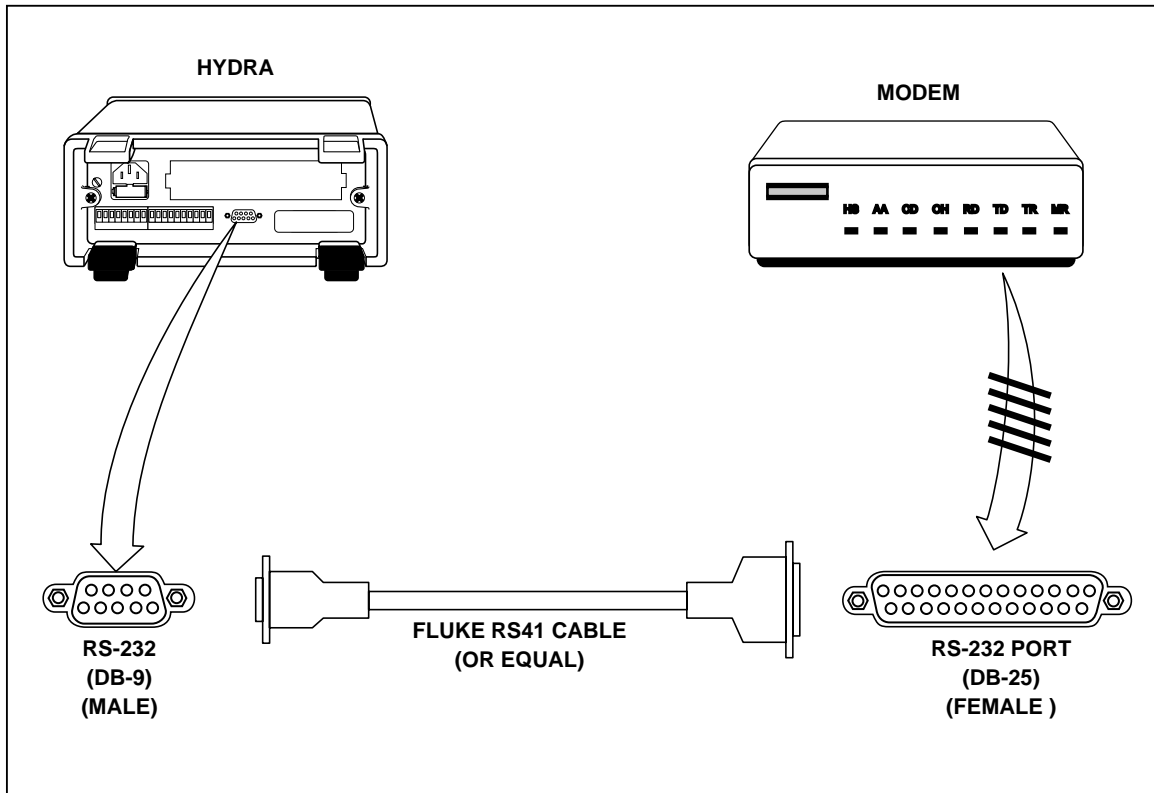

Figure 6-3. Connecting the Modem to an Instrument

op61f.eps

## Configuring the Instrument for Modem Operations

Correct operation of the instrument RS-232/modem link depends on the baud rate, parity, CTS (Clear To Send), and Echo of the link parameters. Perform the procedure in Figure 6-4 to establish the communication link parameters.

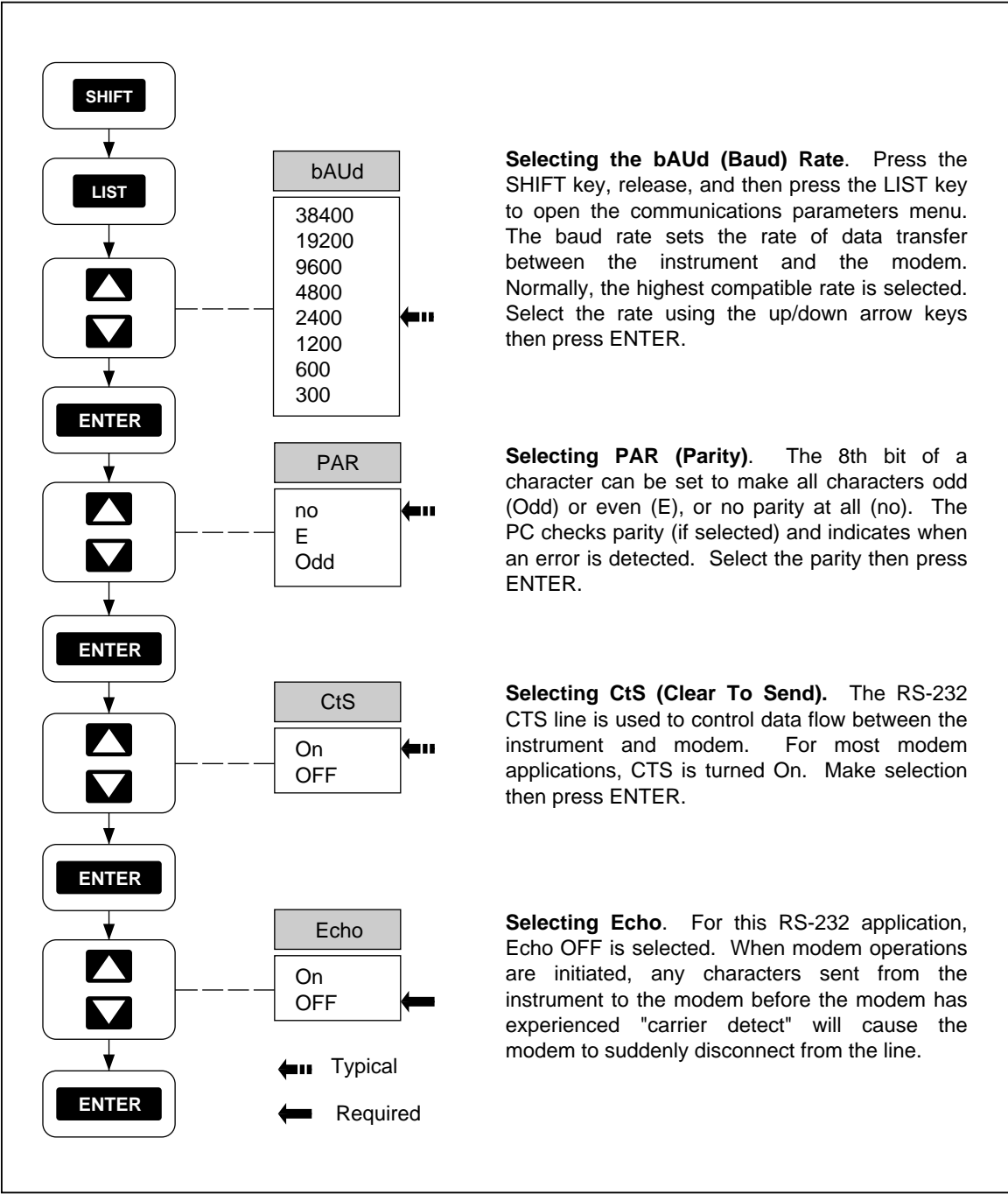

Figure 6-4. Configuring the Instrument RS-232 Port for Modem Operations

op62f.eps

## **Testing the RS-232/Modem Interface**

The PC end of the modem link involves a similar procedure of connecting the correct cable between the PC and modem, and configuring the modem to support the communications link. This is the responsibility of the user due to the variety of available modems and software. Be sure the PC COM port has the same parameters as those selected in Figure 6-4.

When all connections and configurations are complete, the PC should initiate communications with the modem supporting the instrument using the selected communications software. Typically, this means selecting a dial feature, or entering an AT command, e.g., ATDT 123-4567 from the terminal emulation screen. After the connection is made and the terminal emulation screen is present, enter a few <ENTER> characters to clear the instrument buffer, and note the instrument => prompts on the screen. Then enter the command \*IDN? <ENTER> (since ECHO OFF was selected in Figure 6-4, the \*IDN? characters will not appear on screen). The return should be FLUKE,2635A,0,Mn.n An.n Dn.n Ln.n where n.n is replaced with the versions of the displayed parameters. (See the \*IDN? command in Chapter 4 for more information.) The RS-232/modem link is operating correctly and the PC may now operate using Starter or Logger applications software, or custom software.

### **Problems?**

If the modem does not operate after making the RS-232 connection, telephone line connections, and setting the instrument and PC parameters, check the following:

1. No operation of any kind usually indicates a cabling problem, hardware incompatibility, a modem DIP switch problem, or incorrectly selecting ECHO ON in Figure 6-4 (ECHO OFF must be selected).
2. Incorrect operation usually indicates a configuration incompatibility, i.e., the instrument and PC baud rate and parity don't match.
3. Verify the modem configuration data hasn't been lost or corrupted. Some modems use an internal battery to retain configuration data when power is removed, and some modems lose configuration data if power is removed. If the configuration data is suspect, repeat the configuration procedures in this chapter.

# Chapter 7

## Maintenance

Title	Page
Introduction .....	7-3
Cleaning.....	7-3
Line Fuse .....	7-3
Selftest Diagnostics and Error Codes.....	7-4
Performance Tests .....	7-4
Accuracy Verification Test.....	7-7
Channel Integrity Test.....	7-8
Thermocouple Measurement Range Accuracy Test .....	7-9
Four-Terminal Resistance Test .....	7-10
Thermocouple Temperature Accuracy Test.....	7-10
Open Thermocouple Response Test .....	7-11
RTD Temperature Accuracy Test .....	7-13
RTD Temperature Accuracy Test (Using Decade Resistance Source) ....	7-13
RTD Temperature Accuracy Test (Using DIN/IEC 751 RTD).....	7-14
Digital Input/Output Verification Tests .....	7-15
Digital Output Test .....	7-15
Digital Input Test.....	7-16
Totalizer Test.....	7-17
Totalizer Sensitivity Test.....	7-18
Dedicated Alarm Output Test .....	7-18
External Trigger Input Test.....	7-21
Calibration .....	7-21
Variations in the Display.....	7-22
Service .....	7-22

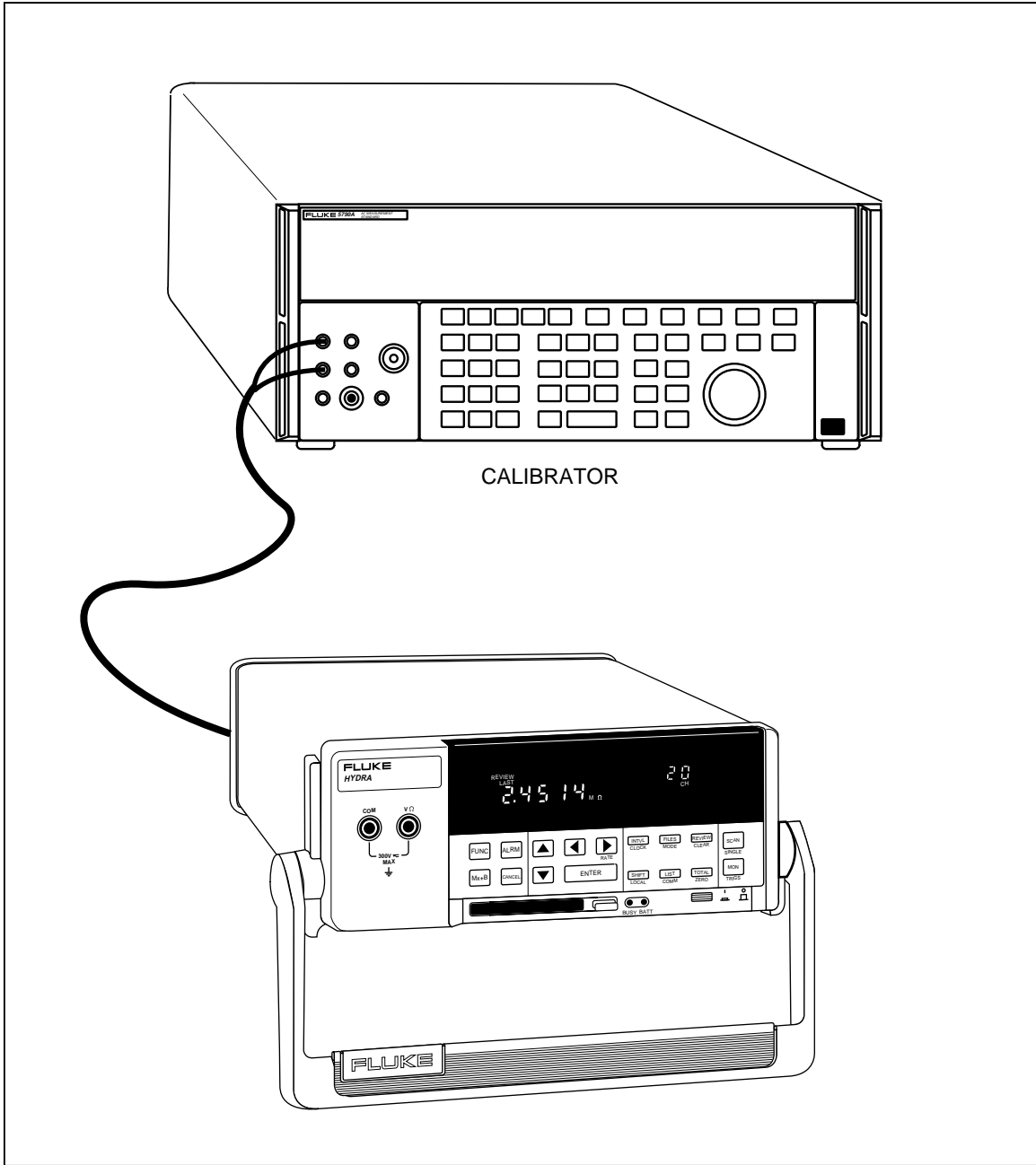

op85f.eps

## Introduction

This chapter describes basic maintenance that the instrument user can perform. Do not attempt any maintenance not described in this chapter. For additional maintenance, service, and calibration procedures, qualified service personnel can refer to the Hydra Series II Service Manual (part number 688868).

## Cleaning

### ⚠ Warning

**Keep the instrument dry to avoid electrical shock to personnel or damage to the instrument. To prevent damage, never apply solvents to the instrument housing.**

For cleaning, wipe the instrument with a cloth that is lightly dampened with water or mild detergent. Do not use aromatic hydrocarbons, chlorinated solvents, or methanol-based fluids.

## Line Fuse

The instrument uses a type "T" 125 mA, 250V (Slow blow) line fuse in series with the power supply. To replace this fuse (located on the rear panel), unplug the line cord and remove the fuse holder with the fuse as shown in Figure 7-1. The instrument is shipped with a replacement fuse secured in the fuse holder.

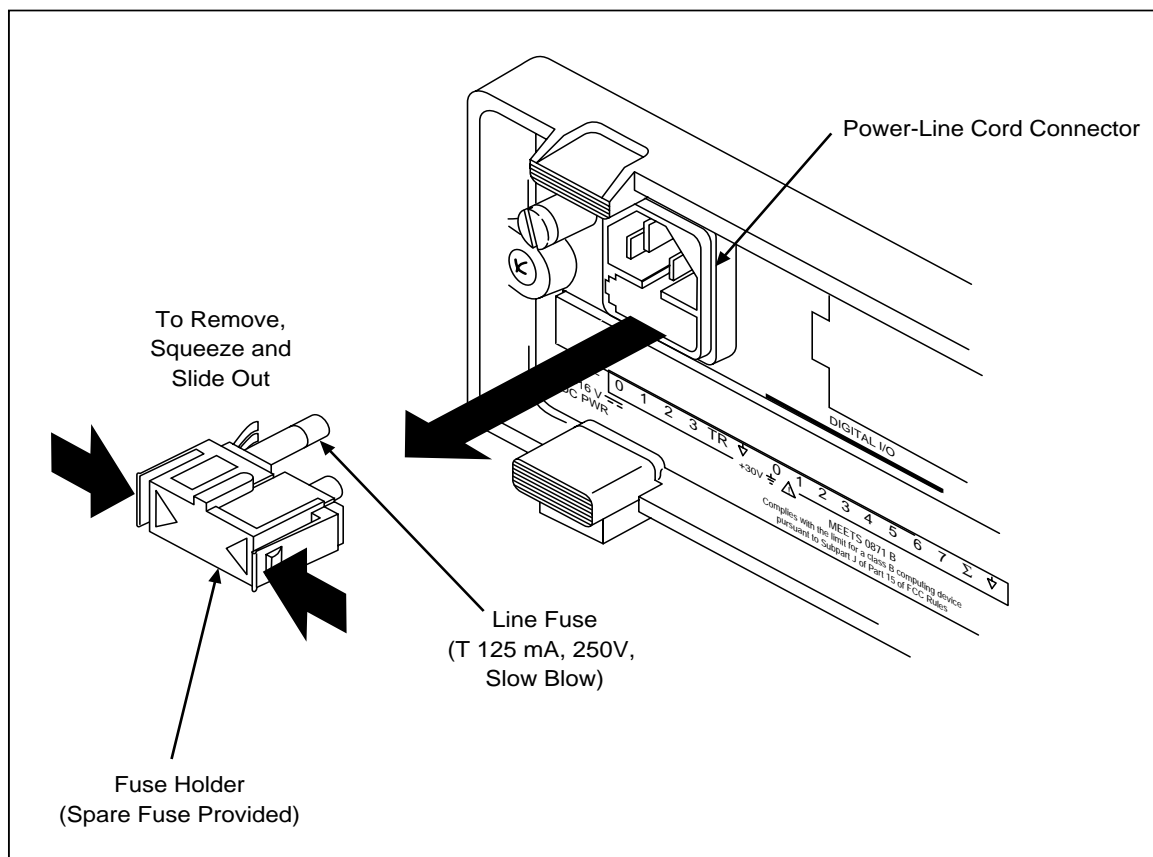

Figure 7-1. Replacing the Line Fuse

op63f.eps

## Selftest Diagnostics and Error Codes

When the instrument is powered up, the entire display lights.

### Note

To hold the display fully lit, press and hold the **SHIFT** key, then press **POWER ON** and wait a moment for the instrument to beep. Then release **SHIFT**. The entire display will now stay on until you press any button; the power-up sequence then resumes.

Selftest diagnostics are performed each time the instrument is powered up. Any errors encountered during this initial 4-second period are displayed momentarily. Even in the presence of an error, the instrument still attempts to complete the selftest routine and begin normal operation.

An error indicates that a malfunction has occurred and maintenance is required. If you encounter an error, note the number or letter and consult Table 7-1. See if the instrument repeats the error. If the problem persists and you intend to repair the instrument yourself, refer to the Service Manual. Otherwise, package the instrument securely (using the original container if available.) Then forward the package, postage paid, to the nearest Fluke/Philips Service Center. Include a description of the problem. Fluke assumes no responsibility for damage in transit.

## Performance Tests

When received, the 2635A Hydra Series II is calibrated and in operating condition. The following Performance Verification Procedures are provided for acceptance testing upon initial receipt or to verify correct instrument operation. All tests may be performed in sequence to verify overall operation, or the tests may be run independently.

If the instrument fails a performance test, calibration adjustment and/or repair is needed. To perform these tests, you will need a Fluke 5700A Multifunction Calibrator or equipment meeting the minimum specifications given in Table 7-2.

Table 7-1. Power-Up Error Codes

Error	Description
1	Boot ROM checksum error
2	Instrument ROM checksum error
3	Internal RAM test failed
4	Display power-up test failure
5	Display not responding
6	Instrument configuration corrupted
7	instrument calibration data corrupted
8	Instrument not calibrated
9	A/D converter not responding
A	A/D converter ROM test failure
b	A/D converter RAM test failure
C	A/D converter selftest failed
d	Memory Card interface not installed



Each of the measurements listed in the following steps assume the instrument is being tested after a 1/2 hour warmup, in an environment with an ambient temperature of 18 to 28°C, and a relative humidity of less than 70%.

*Note*

*All measurements listed in the performance test tables are made in the slow reading rate unless otherwise noted.*

**⚠ Warning**

**The 2635A instrument contains high voltages that can be dangerous or fatal. Only qualified personnel should attempt to service the instrument.**

**Table 7-2. Recommended Test Equipment**

Instrument Type	Minimum Specification			Recommended Model
Multifunction Calibrator	DC Voltage:			Fluke 5700A
	Range: 90 mV to 300V dc Accuracy: .005%			
	AC Voltage:			
	Frequency	Voltage	Accuracy	
	1 kHz	29 mV to 300V	0.05%	
	100 kHz	15 mV to 300V	1.25%	
Frequency:				
10 kHz	1V rms	.0125%		
Decade Resistance Source	Ohms		Accuracy	General Resistance Inc. Model RDS 66A
	290Ω		0.0125%	
	2.9 kΩ		0.0125%	
	29 kΩ		0.0125%	
	290 kΩ		0.0125%	
	2.9 MΩ		0.0125%	
Mercury Thermometer Thermocouple Probe Room Temperature Oil/Water Bath Multimeter Signal Generator	<i>Note</i>			Princo ASTM-56C Fluke P-20T  Fluke 77 Fluke 6011A
	<i>The 5700A Calibrator provides 0.05% accuracy (rated) on the 3.0 kΩ, 30 kΩ, 300 kΩ and 3.0 MΩ ranges. The 5700A can be used for 0.06% accuracy on the 300Ω range.</i>			
	0.02 degrees Celsius resolution			
	Type T			
	Thermos bottle and cap			
Measures +5V dc				
Sinewave, 0.5 to 1V rms 10 Hz to 5 kHz				
Alternate Equipment List (Minimum specifications are the same as in the Standard Equipment List)				
Instrument Type		Recommended Model		
DC Voltage Calibrator		Fluke 5700A		
DMM Calibrator		Fluke 5100B (for AC Volts only)		
Function/Signal Generator		Philips PM5193 or Fluke 6011A		
Decade Resistance Source		Gen Rad 1433H		

### Accuracy Verification Test

1. Power up the instrument and allow the temperature to stabilize for 30 minutes.
2. Connect a cable from the Output VA HI and LO connectors of the 5700A to the V $\Omega$  and COM connectors on the front panel of the Hydra Series II. Select the channel 0 function and range on the Hydra Series II and the input level from the 5700A using the values listed in Table 7-3. Press the **(MON)** (monitor) button to measure and display the measurement value for channel 0. The display should read between the minimum and maximum values listed in the table.

**Table 7-3. Performance Tests (Voltage, Resistance, and Frequency)**

FUNCTION	RANGE	INPUT LEVEL	FREQUENCY	DISPLAY ACCURACY (1 Year, 18-28°C)	
				MIN	MAX
DC Volts	90 mV	short (0)	--	-0.006	0.006
	90 mV	90 mV	--	89.972	90.028
	300 mV	0V	--	-0.02	0.02
	300 mV	150 mV	--	149.94	150.06
	300 mV	290 mV	--	289.91	290.09
	3V	2.9V	--	2.8991	2.9009
	-3V	-2.9V	--	-2.9009	-2.8991
	30V	29V	-	28.991	29.009
	150V	150V	--	149.94	150.06
	300V	290V	--	289.91	290.09
<i>NOTE</i> Voltages greater than 150V can only be applied to channels 0, 1, and 11.					
AC Volts	300 mV	20 mV	1 kHz	19.71	20.29
	300 mV	20 mV	100 kHz	18.50	21.50
	300 mV	290 mV	1 kHz	289.28	290.72
	3V	290 mV	100 kHz	275.00	305.00
	3V	2.9V	1 kHz	2.8937	2.9063
	30V	29V	1 kHz	28.931	29.069
	150V	150V	1 kHz	149.54	150.46
	300V	290V	1 kHz	289.34	290.66
<i>NOTE</i> Voltages greater than 150V can only be applied to channels 0, 1, and 11. The rear Input Module must be installed when measuring ac volts on channel 0.					
<i>NOTE</i> For 2-terminal measurements, the resistance accuracy given in this table applies to Channel 0 and makes allowance for up to 0.05 ohm of lead wire resistance. You must add any additional lead wire resistance present in your set up to the resistance values given in this table.					
Resistance	Using inputs in decades of 3:				
	300 $\Omega$	short		0.00	0.09
		300 $\Omega$		299.90	300.15
	3 k $\Omega$	short		0.0000	0.0003
		3 k $\Omega$		2.9989	3.0011
	30 k $\Omega$	30 k $\Omega$		29.990	30.010
	300 k $\Omega$	300 k $\Omega$		299.88	300.12
	3 M $\Omega$	3 M $\Omega$		2.9979	3.0021

**Table 7-3. Performance Tests (Voltage, Resistance, and Frequency) (cont)**

Using inputs in decades of 1.9:					
	300 $\Omega$	short		0.00	0.09
		190 $\Omega$		189.93	190.12
	3 k $\Omega$	short		0.0000	0.0003
		1.9 k $\Omega$		1.8992	1.9008
	30 k $\Omega$	19 k $\Omega$		18.992	19.008
	300 k $\Omega$	190 k $\Omega$		189.91	190.09
	3 M $\Omega$	1.9 M $\Omega$		1.8983	1.9017
Using inputs in decades of 1:					
	300 $\Omega$	short		0.00	0.09
		100 $\Omega$		99.95	100.10
	3 k $\Omega$	short		0.0000	0.0003
		1 k $\Omega$		0.9995	1.0006
	30 k $\Omega$	10 k $\Omega$		9.995	10.005
	300 k $\Omega$	100 k $\Omega$		99.94	100.06
	3 M $\Omega$	1 M $\Omega$		0.9990	1.0010
	10 M $\Omega^*$	10 M $\Omega$		9.979	10.021
*Optional test point if standards available.					
<b>NOTE</b>					
<p><i>All channels (0 through 20) can accommodate 2-terminal resistance measurements. Channel 0, with only two connections, cannot be used for 4-terminal measurements. Four-terminal resistance measurements can be defined for channels 1 through 10 only. Channels 11 through 20 are used, as required, for 4-terminal to provide the additional two connections. For example, a 4-terminal set up on channel 1 uses channels 1 and 11, each channel providing two connections.</i></p>					
Frequency	90 kHz/2V p-p	10kHz		9.994	10.006

### Channel Integrity Test

Ensure that the Accuracy Verification Test for channel 0 meets minimum acceptable levels before performing this test.

1. Switch OFF power to the instrument and disconnect all high voltage inputs.
2. Remove the Input Module from the rear of the instrument. Open the Input Module and connect a pair of test leads to the H (high) and L (low) terminals of channel 1. Reinstall the Input Module into the instrument.
3. Connect the ends of the test leads together to apply a short (0 ohms).
4. Reconnect power and switch the instrument ON.

5. For channel 1, select the two-terminal ohms function and 300 ohms range on the Hydra Series II. Press **(MON)** and ensure the display reads a resistance of less than or equal to 4.0 ohms. (This test assumes that lead wire resistances are less than 0.1Ω.)
6. Open the ends of the test leads and ensure that the display reads OL" (overload).
7. Press **(MON)**. This will stop the measurement.
8. Connect a cable from the Output VA HI and LO of the 5700A to the Input Module test leads (observe proper polarity).
9. Select the VDC function and 300 volt range on the Hydra Series II and first apply 0V dc then 290V dc input from the 5700A. Ensure the display reads between the minimum and maximum values as shown in Table 7-3 for the 0 and 290V dc input levels.

*Note*

*Channels 0, 1, and 11 have a maximum input of 300V dc or ac (rms). The maximum input for all other channels is 150V dc or ac (rms).*

10. With the exception of the selected voltage range and input voltage from the 5700A, repeat steps 1 through 9 for each remaining Input Module channel (2 through 20). Channels 2 through 10 and 12 through 20 should be configured for the 150V dc range and an input voltage of 150 volts.

**Thermocouple Measurement Range Accuracy Test**

Ensure that the Accuracy Verification Test for channel 0 meets minimum acceptable levels before performing this test.

Thermocouple temperature measurements are accomplished using Hydra Series II's 90 mV and internal 900 mV dc ranges. (The 900 mV range is not configurable from the instrument front panel.) This procedure will provide the means to test these ranges.

Testing the 900 mV dc range requires computer interfacing with a host (terminal or computer). The host must send commands to select this range. This range cannot be selected from the Hydra Series II front panel.

1. Ensure that communication parameters ( i.e., transmission mode, baud rate, parity, CTS, and echo mode) on the Hydra Series II and the host are properly configured to send and receive serial data. Refer to Chapter 4 "Computer Operations."
2. Power up Hydra Series II and allow the temperature to stabilize for 30 minutes.
3. Connect a cable from the Output VA HI and LO connectors of the 5700A to the VΩ and COM connectors on the front panel of the Hydra Series II.
4. Set the 5700A to output 0V dc.
5. Using either a terminal or a computer running a terminal emulation program as the selected host, send the following commands to Hydra Series II:

FUNC 0,VDC,5 <CR>

MON 1,0 <CR>

MON\_VAL? <CR>

The returned value for channel 0 should be 0 mV ±0.006 mV.

Set the 5700A to output 90 mV DC. Send the following command:

MON\_VAL? <CR>

The value returned should now be  $90\text{ mV} \pm 0.028\text{ mV}$  (between 89.97 and 90.028 mV).

6. Change Hydra Series II's channel 0 function to the internal 900 mV dc range by redefining channel 0. Send the following commands:

MON 0 <CR>

FUNC 0,VDC,6 <CR>

Set the 5700A to output 0.9V dc. Send the following commands:

MON 1,0 <CR>

MON\_VAL? <CR>

The value returned should be  $900\text{ mV} \pm 0.21\text{ mV}$  (899.79 to 900.21mV.)

### **Four-Terminal Resistance Test**

Ensure that Channel 0's Accuracy Verification Test for DC Volts and Resistance meets minimum acceptable levels.

1. Switch OFF power to the instrument and disconnect all high voltage inputs.
2. Remove the Input Module from the rear of the instrument. Open the Input Module and connect a pair of test leads (keep as short as possible) to the H (high) and L (low) terminals of channel 1, and connect a second pair of test leads to the H and L terminals of channel 11. Reinstall the Input Module into the instrument.
3. Observing polarity connect channel 1's test leads to the Sense HI and LO terminals of the 5700A, and connect channel 11's test leads to the Output HI and LO terminals of the 5700A. Connect as shown in Figure 7-2.
4. Switch the instrument ON.
5. Select the Four-terminal OHMS function, AUTO range, for channel 1 on the Hydra Series II.
6. Set the 5700A to output the resistance values listed in Table 7-3 (Use decades of 1.9).
7. On Hydra Series II press **MON** and ensure the display reads between the minimum and maximum values shown on Table 7-3.
8. The Four-terminal Resistance Test is complete. However, if you desire to perform this test on Input Module channels (2 through 10), repeat steps 1 through 7, substituting the appropriate channel number.

#### *Note*

*Four-Terminal connections are made using pairs of channels. Four-terminal measurements can be made only on channels 1 through 10 (n). The accompanying pairs are channels 11 through 20 (n+10).*

### **Thermocouple Temperature Accuracy Test**

Ensure that the Thermocouple Measurement Range Accuracy Test meets minimum acceptable levels before performing this test.

1. Switch OFF power to the instrument and disconnect all high voltage inputs.
2. Remove the Input Module from the rear of the instrument. Open the Input Module and connect a T-type thermocouple to the H (blue lead) and L (red lead) terminals of channel 1. Reinstall the Input Module into the instrument.

*Note*

*If other than a T-type thermocouple is used, be sure that the instrument is set up for the type of thermocouple used.*

3. Reconnect power and switch the instrument ON.
4. Insert the thermocouple and a mercury thermometer in a room temperature bath. Allow 20 minutes for thermal stabilization.
5. Select the temperature and T-type thermocouple function for channel 1. Press **MON**.
6. The value displayed should be the temperature of the room temperature bath as measured by the mercury thermometer (within tolerances given in Table 7-4, plus any sensor inaccuracies.).
7. The Thermocouple Temperature Accuracy Test is complete. However, if you desire to perform this test on any other Input Module channel (2 through 20), repeat steps 1 through 6, substituting the appropriate channel number.

**Open Thermocouple Response Test**

1. Switch OFF power to the instrument and disconnect all high voltage inputs.
2. Remove the Input Module from the rear of the instrument. Open the Input Module and connect test leads to the H (high) and L (low) terminals of channel 1. Reinstall the Input Module into the instrument.

**Table 7-4. Performance Tests for Thermocouple Temperature Function (ITS-90)**

Thermocouple Type	Thermocouple Accuracy Specifications 1 Year @ 18-28 Degrees C
J	±0.40°C
K	±0.44°C
N	±0.53°C
E	±0.38°C
T	±0.45°C

1. Reconnect power and switch the instrument ON.
2. Connect the test leads from the Input Module to an 820 ohm resistor.
3. Select the temperature and T-type thermocouple function for channel 1. Press **MON**.
4. The value displayed should approximate the ambient temperature.
5. Replace the 820 ohm resistor with a 4 kilohm resistor to simulate a high resistance or open thermocouple.
6. Verify a reading of "otc".
7. The Open Thermocouple Response Test is complete. However, if you desire to perform this test on any other Input Module channel (2 through 20), repeat steps 1 through 8, substituting the appropriate channel number.

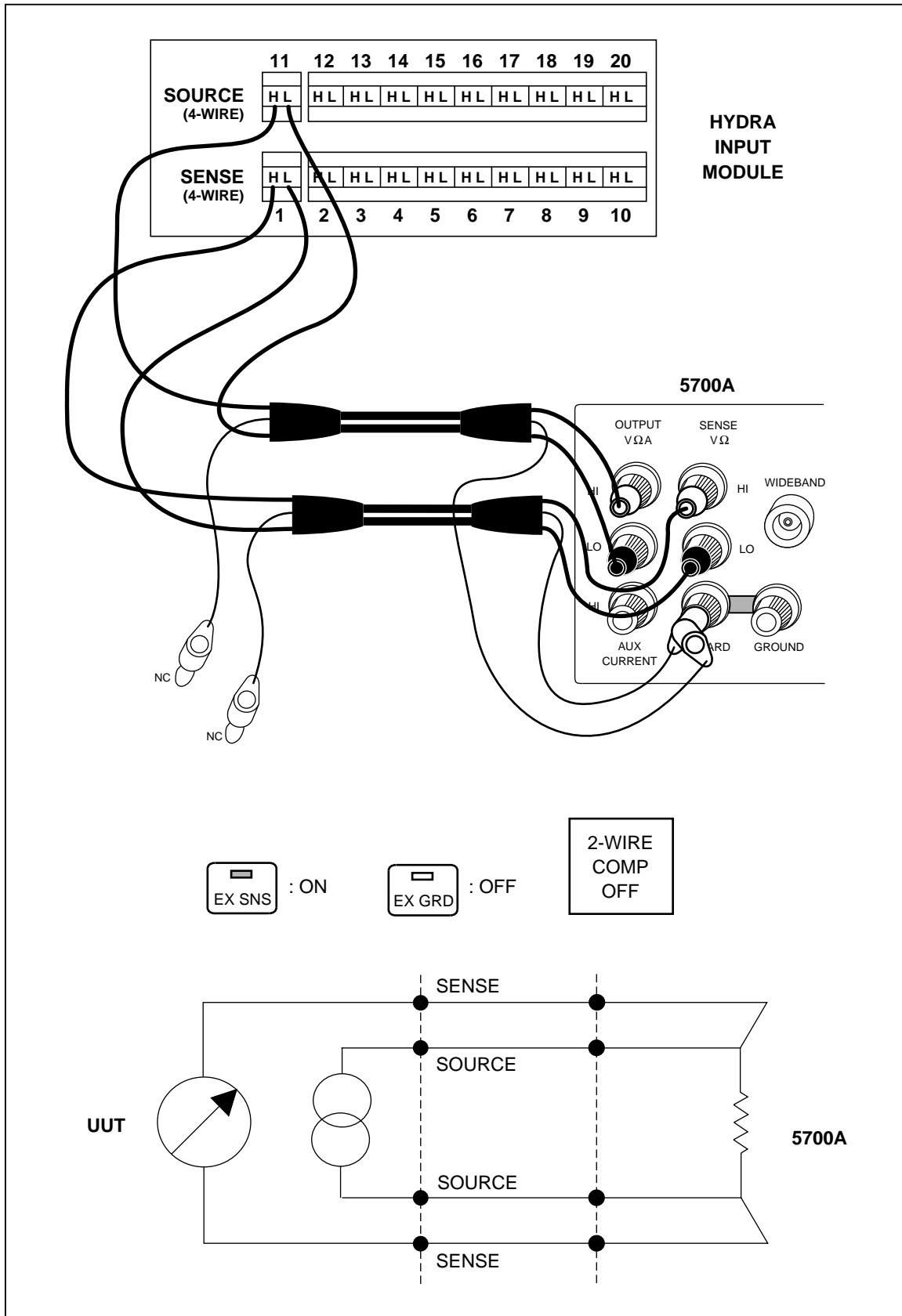

Figure 7-2. Four-Terminal Connections to 5700A

op64f.eps



### **RTD Temperature Accuracy Test**

The following two RTD Temperature Accuracy Tests are different in that one test uses a Decade Resistance Source and the other uses an RTD. Only one of the tests need to be performed to assure operation.

#### *RTD Temperature Accuracy Test (Using Decade Resistance Source)*

Ensure that Channel 0's Accuracy Verification Test for DC Volts and 300 Ohm Resistance Range meets minimum acceptable levels.

1. Switch OFF power to the instrument and disconnect all high voltage inputs.
2. Remove the Input Module from the rear of the instrument. Open the Input Module and connect a pair of test leads (keep as short as possible) to the H (high) and L (low) terminals of channel 1. For Four-terminal performance testing, connect a second pair of test leads to the H (high) and L (low) terminals of channel 11. Reinstall the Input Module into the instrument.
3. Connect channel 1's test leads to the Output HI and LO terminals of the Decade Resistance Source. For Four-terminal performance testing, also connect channel 11's test leads to the Output HI and LO terminals of the Decade Resistance Source. Connect as shown in Figure 7-3.

#### *Note*

*Four-terminal connections are made using pairs of channels. Four-terminal measurements can be made only on channels 1 through 10 (n). The accompanying pairs are channels 11 through 20 (n+10).*

4. Switch the instrument ON.
5. Select the Four-terminal RTD temperature function, RTD type PT, for channel 1 on the Hydra Series II. Press **MON**, select a Decade Resistance value, and ensure the display reads between the minimum and maximum values shown on Table 7-5.
6. The RTD Temperature Accuracy test is complete. However if you desire to perform this test on Input Module channels (2 through 10), repeat steps 1 through 5, substituting the appropriate channel number.

#### *Note*

*The only type of temperature measurement that can be made on channel 0 is two-terminal RTD. Channels 11 through 20 will support only two-terminal RTDs.*

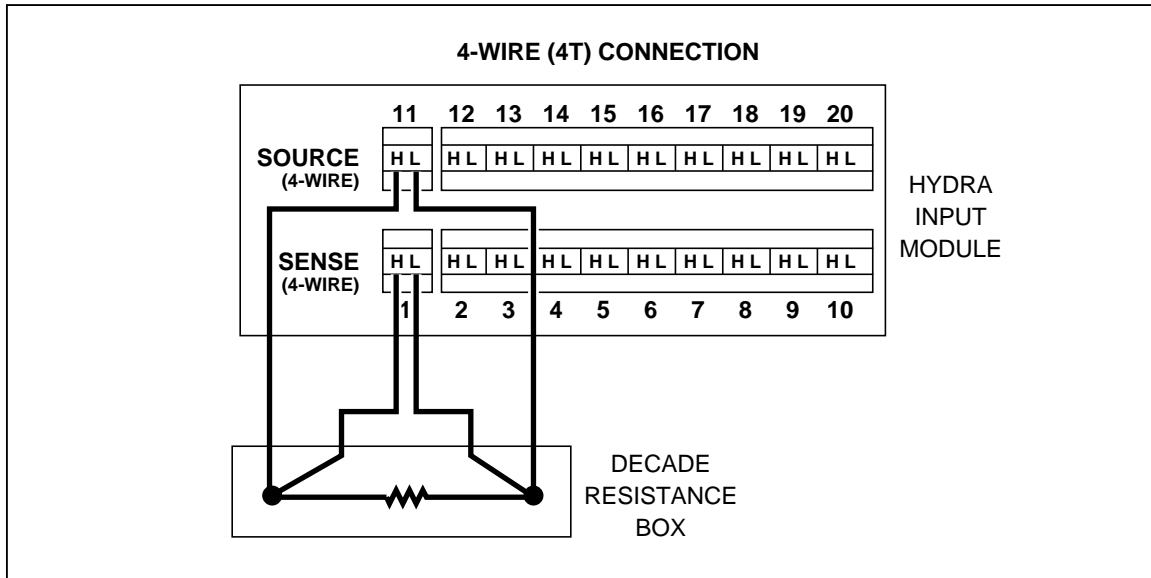

Figure 7-3. Four-Terminal Connections to Decade Resistance Box

op65f.eps

Table 7-5. Performance Tests for RTD Temperature Function (Resistance Source) (DIN/IEC 751 Amendment 2) (ITS-90)

DECADE RESISTANCE SOURCE	TEMPERATURE SIMULATED °C	TEMPERATURE ACCURACY 1 YEAR @ 18-28°C
100 Ω	0	± 0.12°C
200 Ω	266.35	± 0.22°C
300 Ω	557.69	± 0.37°C

*These figures assume that RTD R0 is set to 100.00 ohms for each channel.*

*Accuracy given is for 4-wire measurements only. For 2-wire measurements, degrade the accuracy specifications by 5.2 °C per ohm of single lead wire resistance. For 2-wire measurements, degrade the accuracy by an additional 11°C (channels 1 .. 20) or 0.05°C (channel 0).*

#### RTD Temperature Accuracy Test (Using DIN/IEC 751 RTD)

1. Switch OFF power to the instrument and disconnect all other high voltage inputs.
2. Remove the Input Module from the rear of the instrument. Open the Input Module and connect a Platinum RTD, conforming to the European Standards IEC 751 (DIN 43760).

Two-terminal RTD: Connect the RTD's excitation leads to the H (high) and L (low) terminals of channel 1.

Four-terminal RTD: Connect the RTD's excitation leads (one red and one black wire) to the H (high) and L (low) terminals of channel 1. Connect the RTD's second pair of red and black leads to the H and L leads of channel 11. (Refer to Figure 7-3 for proper connection.) Reinstall the Input Module into the instrument.

*Note*

*Four-terminal connections are made using pairs of channels. Four-terminal measurements can be made only on channels 1 through 10 (n). Their accompanying pairs are channels 11 through 20 (n+10).*

3. Switch the instrument ON.
4. Insert the RTD probe and a mercury thermometer in a room temperature bath. Allow 20 minutes for thermal stabilization.
5. Dependent on the type of connection made in step 2, select either the two-terminal or four-terminal RTD temperature function, RTD type PT (DIN/IEC 751), for channel 1 on the Hydra Series II. Press **(MON)** and ensure the display reads the temperature of the room temperature bath (within tolerances shown in Table 7-6) as measured by the mercury thermometer.
6. The RTD Temperature Accuracy test is complete. However if you desire to perform this test on any other channel (0 or 2 through 20) repeat steps 1 through 5 substituting the appropriate channel number.

*Note*

*The only type of temperature measurement that can be made on channel 0 is two-terminal RTD. Channels 11 through 20 will support only two-terminal RTDs.*

**Table 7-6. Performance Tests for RTD Temperature Function (DIN/ IEC 751 Amendment 2)(ITS-90)**

RTD TYPE	TEMPERATURE ACCURACY SPECIFICATIONS 1 YEAR @ 18-28°C
2-wire (channel 0)	-0.54°C to 0.59°C
2-wire (channels 1-20)	-0.54°C to 11.54°C
4-wire	±0.54°C
Assumes RTD R0 is set to 100.00 Ω for each channel.	

**Digital Input/Output Verification Tests**

Digital Input/Output verification testing requires computer interfacing with a host (terminal or computer). The host must send commands to the instrument to control the digital lines for this test. Refer to Chapter 4 for a description of configuring and operating the instrument.

**Digital Output Test**

1. Ensure that communication parameters ( i.e., transmission mode, baud rate, parity, CTS, and echo mode) on the Hydra Series II and the host are properly configured to send and receive serial data. Refer to Chapter 4.
2. Switch OFF power to the instrument and disconnect all high voltage inputs.
3. Remove the Digital I/O ten terminal connector from the rear of the instrument and all external connections to it. Connect short wires (to be used as test leads) to the GROUND and 0 through 7 terminals. Leave the other wire ends unconnected at this time. Reinstall the connector.
4. Switch power ON to both Hydra Series II and the host. Verify that Hydra Series II is not scanning. If Hydra Series II is scanning, press **(SCAN)** to turn scanning off, then cycle power off-on again.

5. Using a digital multimeter (DMM), verify that all digital outputs (0-7) are in the OFF or HIGH state. This is done by connecting the low or common of the multimeter to the ground test lead and the high of the multimeter to the digital output and verifying a voltage greater than +3.8V dc.
6. Using either a terminal or a computer running a terminal emulation program, set up Hydra Series II to turn Digital Outputs ON (LOW state).

In sequence send the following commands to Hydra Series II and measure that the correct Digital Output line transitioned LOW measures less than +0.8V dc.

```
DO_LEVEL 0,0 <CR>
```

Ensure that output 0 measures a LOW state.

```
DO_LEVEL 1,0 <CR>
```

Ensure that output 1 measures a LOW state.

```
DO_LEVEL 2,0 <CR>
```

Ensure that output 2 measures a LOW state.

Repeat the command for all eight outputs.

7. Set up Hydra Series II to turn Digital Outputs OFF (HIGH state).

In sequence send the following commands to Hydra Series II and measure that the correct Digital Output line transitioned HIGH measures greater than +3.8V dc.

```
DO_LEVEL 0,1 <CR>
```

Ensure that output 0 measures a HIGH state.

```
DO_LEVEL 1,1 <CR>
```

Ensure that output 1 measures a HIGH state.

Repeat the command for all eight outputs.

### *Digital Input Test*

1. Perform the DIGITAL OUTPUT TEST steps 1 through 5.
2. Using either a terminal or a computer running a terminal emulation program, set up Hydra Series II to read the Digital Input lines.

Send the following command to Hydra Series II:

```
DIO_LEVELS? <CR>
```

Verify that the returned value is 255.

#### *Note*

*The number returned is the decimal equivalent of the Digital Input binary word (inputs 0 through 7's status). See Table 7-7 to determine if the number returned corresponds to the bits jumpered to ground in this test.*

3. Jumper input 0 to ground by connecting the ground test lead to input 0's test lead.  
Then send the following command to Hydra Series II:  

```
DIO_LEVELS? <CR>
```

  
Verify that the returned value is 254.
4. Disconnect input 0 from ground then jumper input 1 to ground.

Send the command: DIO\_LEVELS? <CR>

Verify the returned value is 253.

5. Repeat step 4 for each input and verify the correct returned value (See Table 7-7).

**Table 7-7. Digital Input Values**

TERMINAL GROUNDED	STATE OF DIGITAL INPUTS	DECIMAL VALUE
none	inputs 0-7, all HIGH	255
0	inputs 1-7 HIGH, input 0 LOW	254
1	inputs 0,2-7 HIGH, input 1 LOW	253
2	inputs 0-1 and 3-7 HIGH, input 2 LOW	251
3	inputs 0-2 and 4-7 HIGH, input 3 LOW	247
4	inputs 0-3 and 5-7 HIGH, input 4 LOW	239
5	inputs 0-4 and 6-7 HIGH, input 5 LOW	223
6	inputs 0-5 and 7 HIGH, input 6 LOW	191
7	inputs 0-6 HIGH, input 7 LOW	127

### Totalizer Test

This totalizer verification test requires toggling the Digital Output line 0 and using it as the Total input. The test requires computer interfacing with a host (terminal or computer). The host must send commands to the 2635A instrument to control the digital line for this test. Refer to Chapter 4 for a description of configuring and operating Hydra Series II.

1. Ensure that communication parameters ( i.e., transmission mode, baud rate, parity, CTS, and echo mode) on Hydra Series II and the host are properly configured to send and receive serial data. Refer to Chapter 4.
2. Switch OFF power to the instrument and disconnect all high voltage inputs.
3. Remove the Digital I/O ten-terminal connector from the rear of the instrument and all external connections to it. Connect short wires (to be used as test leads) to the DIGITAL I/O terminal 0 and the Total (SUM) terminal. Leave other ends of wires unconnected at this time. Reinstall the connector.
4. Switch ON power to both Hydra Series II and the host.
5. Press the **TOTAL** button on the front panel of Hydra Series II.

Ensure that Hydra Series II displays a 0 value.

6. Jumper the DIGITAL I/O terminal 0 to the Total (SUM) input by connecting the (SUM) terminal test lead to DIGITAL I/O 0's test lead.
7. Using either a terminal or a computer running a terminal emulation program, set up Hydra Series II to toggle (turn ON and OFF) Digital Output 0.

In sequence send the following commands to Hydra Series II and ensure that Hydra Series II measures and displays the correct total value:

DO\_LEVEL 0,0 <CR>

DO\_LEVEL 0,1 <CR>

Ensure that Hydra Series II displays a totalizer count of 1.

8. Again in sequence, send the commands:  
DO\_LEVEL 0,0 <CR>  
DO\_LEVEL 0,1 <CR>  
Hydra Series II should now display a totalizer count of 2.
9. Repeat step 8 for each incremental totalizing count.
10. Set the Hydra Series II's totalized count to a value near full range (65535) and test for overload.  
Send the following commands to Hydra Series II:  
TOTAL 65534 <CR>  
DO\_LEVEL 0,0 <CR>  
DO\_LEVEL 0,1 <CR>  
A totalizer count of 65535 should be displayed.
11. Send:  
DO\_LEVEL 0,0 <CR>  
DO\_LEVEL 0,1 <CR>  
Hydra Series II's display should now read "OL". This indicates that the counter has changed from its maximum count (65535) to zero (0) and has set the Totalize Overflow bit in the Instrument Event Register.

#### *Totalizer Sensitivity Test*

1. Perform the Totalizer Test and ensure that it is operational.
2. Remove the jumper connecting the (SUM) terminal test lead to output 0's test lead.
3. Ensure that Hydra Series II is still in the totalize display mode. If not, press the **TOTAL** button. Reset the totalizer count shown on the display by pressing Hydra Series II's front panel **SHIFT** button followed by **TOTAL** (ZERO) button.  
Hydra Series II's display should now show a value of 0.
4. Connect the output of the signal generator to the SUM and GROUND terminals.
5. Program the signal generator to output a 1.5V rms sine signal at 10 Hz.  
Hydra Series II's display should now show the totalizing value incrementing at a 10 count per second rate.

#### *Dedicated Alarm Output Test*

The Dedicated Alarm Output Test verifies that Alarm Outputs 0 through 3 are functioning properly. Because this test is dependent on voltage readings, the Accuracy Verification Test for channel 0 and the Channel Integrity Test for channels 1 through 3 should be performed if voltage readings are suspect.

1. Switch OFF power to the instrument and disconnect all high voltage inputs.
2. Remove the Alarm Output eight-terminal connector module from the rear of Hydra Series II and all external connections to it. Connect short wires (to be used as test leads) to the GROUND and 0 through 3 terminals. Leave other ends of wires unconnected at this time. Reinstall the connector.

3. Remove the Input Module from the rear of Hydra Series II. Open the Input Module and jumper the H (high) terminal of channels 1, 2, and 3 together. Connect a test lead to the H of channel 1. Also jumper the L (low) terminals of channel 1, 2, and 3 together. Connect a second test lead to the L of channel 1. Reinstall the Input Module into Hydra Series II. Refer to Figure 7-4.
4. Switch power ON.
5. Using a digital multimeter (DMM), verify that alarm outputs 0 through 3 are in the OFF or HIGH state. Perform this test by connecting the low or common of the multimeter to the ground test lead and the high of the multimeter to the alarm output. Verify a voltage greater than +3.8V dc.
6. Connect a cable from the Output VA HI and LO connectors of the 5700A to the V $\Omega$  and COM connectors on the front panel of Hydra Series II. Then jumper Hydra Series II's V $\Omega$  terminal to the H (high) test lead of the Input Module and the COM terminal to the L (low) test lead.
7. On Hydra Series II, select the VDC function, 3V range, and assign a HI alarm limit of +1.0000 for channels 0 through 3. Set up all other channels (4-20) to the OFF function. Select a scan interval of 5 seconds.
8. Set the 5700A to output +0.9900 volts.
9. Press Hydra Series II's **SCAN** button. Hydra Series II should scan channels 0 through 3 every 5 seconds.
10. Using a digital multimeter, again verify that alarm outputs 0 through 3 are in the OFF or HIGH state.
11. Set the 5700A to output +1.1000 volts. Verify that the alarm outputs 0 through 3 are in the ON or LOW state (measure less than +0.8V dc).

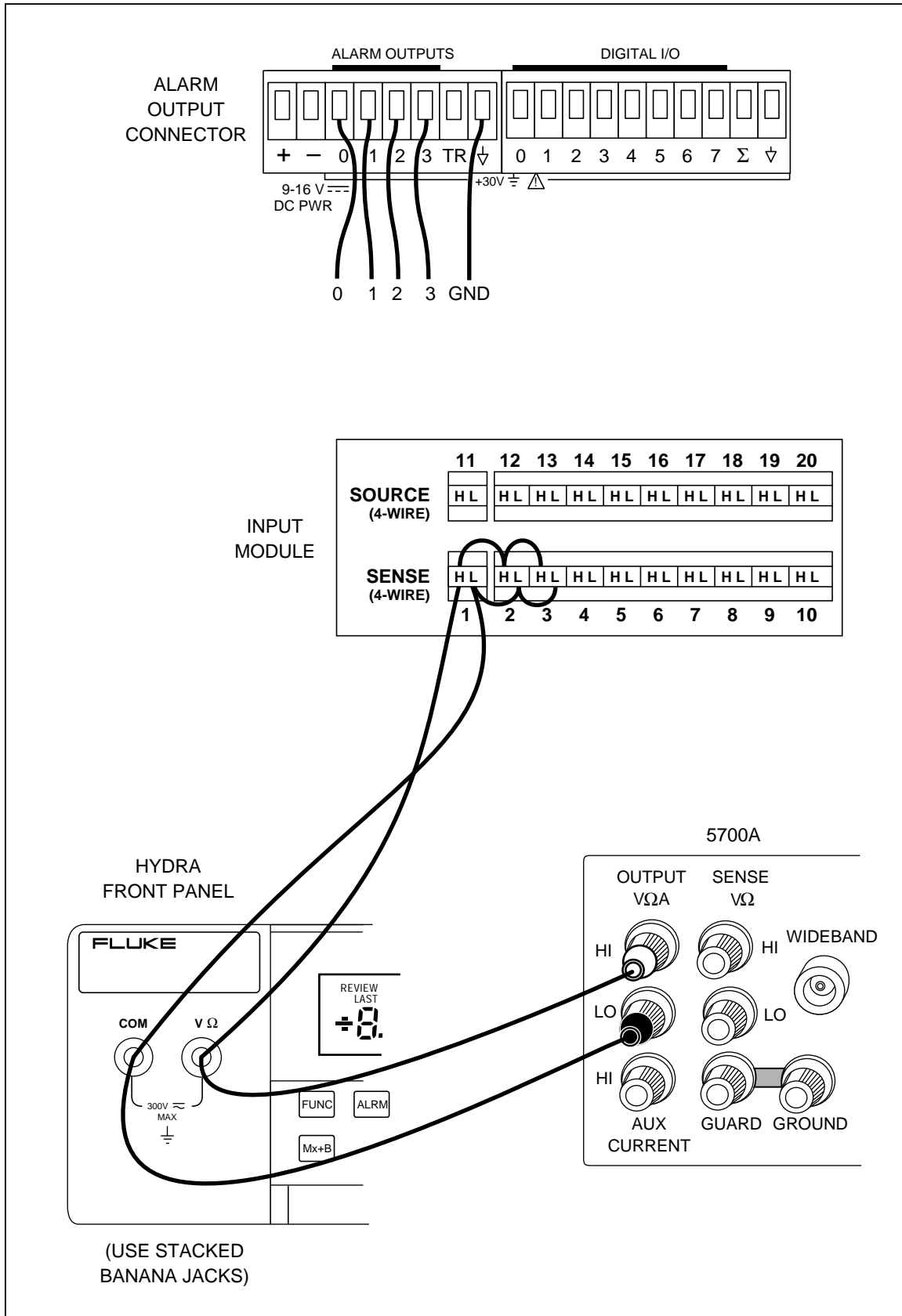

Figure 7-4. Dedicated Alarms Output Test

op66f.eps



### External Trigger Input Test

The External Trigger Input Test verifies that the rear panel trigger input of Hydra Series II is functioning properly.

1. Switch OFF power to the instrument and disconnect all high voltage inputs.
2. Remove the Alarm Output eight terminal connector module from the rear of Hydra Series II and all external connections to it. Connect short wires (to be used as test leads) to the GROUND and TR terminals. Leave other ends of wires unconnected at this time. Reinstall the connector. Refer to Figure 7-5.
3. Switch power ON.
4. On Hydra Series II, select the VDC function, 30V range for channels 0 through 5. Select a scan interval of 30 seconds.
5. Select trigger ON to enable the external trigger input. Press the **SHIFT** and **MON** (TRIGS) buttons (the display shows TRIG), then press either the up or down arrow buttons to display ON. Press **ENTER**.
6. Press Hydra Series II's **SCAN** button. Hydra Series II should scan channels 0 through 5 once every 30 seconds.
7. During the interval when scanning is not occurring, connect (short) the test leads of the TR and ground Alarm Output terminals.

Ensure the connection causes a single scan to occur.

8. Disconnect (open) the TR and ground connection.

Ensure the scan continues to execute at its specified interval.

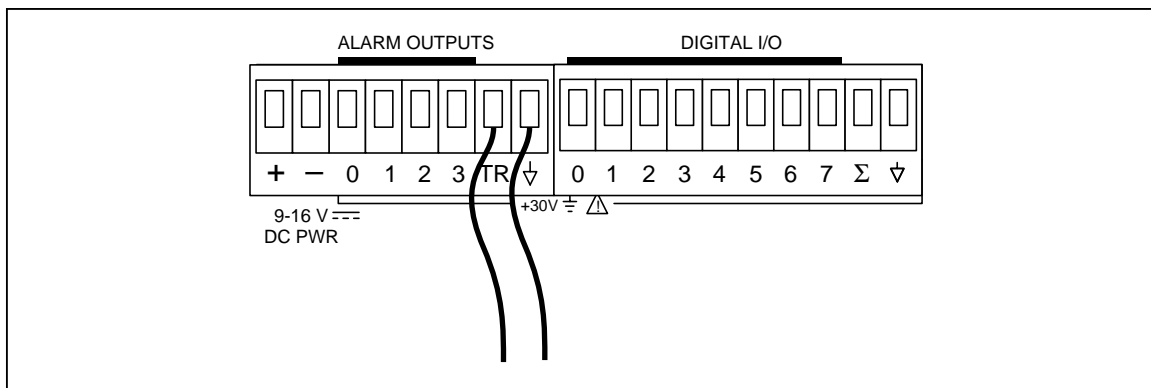

Figure 7-5. External Trigger Test

op67f.eps

## Calibration

### Note

Refer to the Fluke Hydra Series II Service Manual (P/N 688868) for calibration procedures. The instrument must be stabilized in an environment with an ambient temperature of 22 to 24°C and a relative humidity of less than 70% and must have been turned on for at least 30 minutes prior to calibration.

The instrument features closed-case calibration controlled over the Computer Interface. Using known reference sources, closed-case calibration has many advantages. There are

no parts to disassemble, no mechanical adjustments to make, and the instrument can be calibrated by an automated instrumentation system.

The instrument should normally be calibrated on a regular cycle, typically every 90 days or 1 year. The chosen calibration cycle depends on the accuracy specification you wish to maintain. The instrument should also be calibrated if it fails the performance test or has undergone repair.

*Note*

*Do not press CAL ENABLE unless you have a copy of the Service Manual and intend to calibrate the instrument. If you have activated calibration and wish to exit calibration, press CAL ENABLE until CAL disappears from the display (or press power OFF).*

Refer to the Hydra Series II Service Manual for the essential calibration procedures.

## **Variations in the Display**

Under normal operation, the display presents various combinations of brightly and dimly lit annunciators and digits. However, you may encounter other, random irregularities across different areas of the display under the following circumstances:

- After prolonged periods of displaying the same information.
- If the display has not been used for a prolonged period.

This phenomenon can be cleared by activating the entire display and leaving it on overnight (or at least for several hours). Use the following procedure to keep the display fully lit:

1. With power OFF, press and hold **SHIFT**, then press power ON.
2. Wait a moment for the instrument to beep, then release **SHIFT**. The entire display will now stay on until you are ready to deactivate it.
3. At the end of the activation period, press any button on the front panel; the instrument resumes the mode in effect prior to the power interruption (Active or Inactive).

## **Service**

If the instrument fails, check that operating instructions presented earlier in this manual are being followed. If the problem cannot be remedied, forward the instrument, postage paid, to the nearest Fluke/Philips Service Center. Be sure to pack the instrument securely; use the original container if available. Include a description of the problem. Fluke assumes NO responsibility for damage in transit.

To locate an authorized service center, visit us on the World Wide Web: [www.fluke.com](http://www.fluke.com) or call Fluke using any of the phone numbers listed below.

1-800-44-FLUKE (1-800-443-5853) in U.S.A. and Canada  
+31 402-678-200 in Europe  
+81-3-3434-0181 Japan  
+65-\* -276-6196 Singapore  
+1-425-356-5500 in other countries

# ***Appendices***

<b>Appendix</b>	<b>Title</b>	<b>Page</b>
A	Specifications.....	A-1
B	Crosstalk Considerations .....	B-1
C	Binary Upload of Logged Data.....	C-1
D	RS-232 Cabling.....	D-1
E	8-Bit Binary-Coded-Decimal Table.....	E-1
F	Memory Card File Formats.....	F-1
G	True RMS Measurements .....	G-1



# ***Appendix A Specifications***

## ***Introduction***

The instrument specifications presented here are applicable within the conditions listed in the Environmental chapter.

The specifications state total instrument accuracy following calibration, including:

- A/D errors
- Linearization conformity
- Initial calibration errors
- Isothermality errors
- Relay thermal emf's
- Reference junction conformity
- Temperature coefficients
- Humidity errors

Sensor inaccuracies are not included in the accuracy figures.

## ***Accuracies at Ambient Temperatures Other than Specified***

To determine typical accuracies at temperatures intermediate to those listed in the specification tables, linearly interpolate between the applicable 0°C to 60°C and 18°C to 28°C accuracy specifications.

## ***Response Times***

Refer to Typical Scanning Rate and Maximum Autoranging Time later in this Appendix.

## ***DC Voltage Measurements***

### ***Resolution***

See Table A-1

Table A-1. DC Voltage Measurements - Resolution

Range	Resolution	
	Slow	Fast
90 mV*	1 $\mu$ V	10 $\mu$ V
300 mV	10 $\mu$ V	0.1 mV
3V	0.1 mV	1 mV
30V	1 mV	10 mV
300V	10 mV	0.1 V
900 mV**	10 $\mu$ V	0.1 mV

\* Not used in Autoranging  
 \*\*\* Computer interface only (see FUNC command).

**Accuracy**

See Table A-2.

Table A-2. DC Voltage Measurements - Accuracy

RANGE	ACCURACY $\pm$ (% $\pm$ V)				
	18°C TO 28°C			0°C TO 60°C	
	90 DAYS SLOW	1 YEAR SLOW	1 YEAR FAST	1 YEAR SLOW	1 YEAR FAST
90 mV*	.019% + 6 $\mu$ V	.024% + 6 $\mu$ V	.044% + 20 $\mu$ V	.068% + 6 $\mu$ V	.088% + 20 $\mu$ V
300 mV	.018% + 20 $\mu$ V	.023% + 20 $\mu$ V	.040% + 0.2 mV	.067% + 20 $\mu$ V	.084% + 0.2 mV
3V	.019% + 0.2 mV	.024% + 0.2 mV	.041% + 2 mV	.065% + 0.2 mV	.082% + 2 mV
30V	.019% + 2 mV	.024% + 2 mV	.041% + 20 mV	.086% + 2 mV	.103% + 20 mV
150/300V	.019% + 20 mV	.024% + 20 mV	.041% + 0.2 V	.087% + 20 mV	.104% + 0.2 V
900 mV* **	.016% + 20 $\mu$ V	.021% + 20 $\mu$ V	.037% + 0.3 mV	.064% + 20 $\mu$ V	.096% + 0.3 mV

\* Not used in Autoranging.  
 \*\* Computer interface only (see FUNC command).

**Input Impedance**

100 M $\Omega$  minimum in parallel with 150 pF maximum for all ranges 3V and below 10 M $\Omega$  in parallel with 100 pF maximum for the 30V and 300V ranges

**Normal Mode Rejection**

53 dB minimum at 60 Hz  $\pm$ 0.1%, slow rate  
 47 dB minimum at 50 Hz  $\pm$ 0.1%, slow rate

**Common Mode Rejection**

120 dB minimum at dc, 1 k $\Omega$  imbalance, slow rate  
 120 dB minimum at 50 or 60 Hz  $\pm$ 0.1%, 1 k $\Omega$  imbalance, slow rate

**Maximum Input**

300V dc or ac rms on any range for channels 0,1, and 11  
150V dc or ac rms for channels 2 to 10 and 12 to 20  
Voltage ratings between channels must not be exceeded.

**Cross-Talk Rejection**

Refer to Appendix B.

### AC Voltage Inputs (True rms AC Voltage, AC-Coupled Inputs)

#### Resolution

See Table A-3.

**Table A-3. AC Voltage Measurements - Resolution**

Range	Resolution		Minimum Input for Rated Accuracy
	Slow	Fast	
300 mV	10 $\mu$ V	100 $\mu$ V	20 mV
3V	100 $\mu$ V	1 mV	200 mV
30V	1 mV	10 mV	2V
150/300V	10 mV	100 mV	20V

#### Accuracy

See Table A-4.

**Table A-4. AC Voltage Measurements - Accuracy**

Range	Frequency	1 Year Accuracy $\pm$ (% $\pm$ V)			
		18°C to 28°C		0°C to 60°C	
		Slow	Fast	Slow	Fast
300 mV	20 Hz - 50 Hz	1.43% + 0.25 mV	1.43% + 0.4 mV	1.54% + 0.25 mV	1.54% + 0.4 mV
	50 Hz - 100 Hz	0.30% + 0.25 mV	0.30% + 0.4 mV	0.41% + 0.25 mV	0.41% + 0.4 mV
	100 Hz - 10 kHz	0.16% + 0.25 mV	0.16% + 0.4 mV	0.27% + 0.25 mV	0.27% + 0.4 mV
	10 kHz - 20 kHz	0.37% + 0.25 mV	0.37% + 0.4 mV	0.68% + 0.25 mV	0.68% + 0.4 mV
	20 kHz - 50 kHz	1.9% + 0.30 mV	1.9% + 0.5 mV	3.0% + 0.30 mV	3.0% + 0.5 mV
	50 kHz - 100 kHz	5.0% + 0.50 mV	5.0% + 1.0 mV	7.0% + 0.50 mV	7.0% + 1.0 mV
3V	20 Hz - 50 Hz	1.42% + 2.5 mV	1.42% + 4 mV	1.53% + 2.5 mV	1.53% + 4 mV
	50 Hz - 100 Hz	0.29% + 2.5 mV	0.29% + 4 mV	0.40% + 2.5 mV	0.40% + 4 mV
	100 Hz - 10 kHz	0.13% + 2.5 mV	0.13% + 4 mV	0.24% + 2.5 mV	0.24% + 4 mV
	10 kHz - 20 kHz	0.22% + 2.5 mV	0.22% + 4 mV	0.35% + 2.5 mV	0.35% + 4 mV
	20 kHz - 50 kHz	0.6% + 3.0 mV	0.6% + 5 mV	0.9% + 3.0 mV	0.9% + 5 mV
	50 kHz - 100 kHz	1.0% + 5.0 mV	1.0% + 10 mV	1.4% + 5.0 mV	1.4% + 10 mV
30V	20 Hz - 50 Hz	1.43% + 25 mV	1.43% + 40 mV	1.58% + 25 mV	1.58% + 40 mV
	50 Hz - 100 Hz	0.29% + 25 mV	0.29% + 40 mV	0.45% + 25 mV	0.45% + 40 mV
	100 Hz - 10 kHz	0.15% + 25 mV	0.15% + 40 mV	0.30% + 25 mV	0.30% + 40 mV
	10 kHz - 20 kHz	0.22% + 25 mV	0.22% + 40 mV	0.40% + 25 mV	0.40% + 40 mV
	20 kHz - 50 kHz	0.9% + 30 mV	0.9% + 50 mV	1.1% + 30 mV	1.1% + 50 mV
	50 kHz - 100 kHz	2.0% + 50 mV	2.0% + 100 mV	2.2% + 50 mV	2.2% + 100 mV
300V	20 Hz - 50 Hz	1.42% + 0.25V	1.42% + 0.4V	1.57% + 0.25V	1.57% + 0.4V
	50 Hz - 100 Hz	0.29% + 0.25V	0.29% + 0.4V	0.44% + 0.25V	0.44% + 0.4V
	100 Hz - 10 kHz	0.14% + 0.25V	0.14% + 0.4V	0.29% + 0.25V	0.29% + 0.4V
	10 kHz - 20 kHz	0.22% + 0.25V	0.22% + 0.4V	0.38% + 0.25V	0.38% + 0.4V
	20 kHz - 50 kHz	0.9% + 0.30V	0.9% + 0.5V	1.0% + 0.30V	1.0% + 0.5V
	50 kHz - 100 kHz	2.5% + 0.50V	2.5% + 1.0V	2.6% + 0.50V	2.6% + 1.0V



## Temperature Measurements (Thermocouples)

### Accuracy

See Table A-5.

**Table A-5. Temperature Measurements - Accuracy (Thermocouples) (IPTS-68)**

Thermocouple		Accuracy ( $\pm$ °C)*				
		18°C to 28°C			0°C TO 60°C	
Type	Temperature (C°)	90 Days Slow	1 Year Slow	1 Year Fast	1 Year Slow	1 Year Fast
J	-100 to -30	0.42	0.43	0.90	0.54	1.08
	-30 to 150	0.37	0.38	0.80	0.57	1.01
	150 to 760	0.44	0.48	0.93	0.88	1.37
K	-100 to -25	0.51	0.52	1.12	0.64	1.30
	-25 to 120	0.43	0.44	0.94	0.62	1.15
	120 to 1000	0.81	0.87	1.57	1.47	2.22
	1000 to 1372	1.05	1.15	2.03	2.01	2.95
N	-100 to -25	0.61	0.62	1.42	0.73	1.60
	-25 to 120	0.53	0.54	1.21	0.68	1.39
	120 to 410	0.50	0.52	1.11	0.74	1.31
	410 to 1300	1.00	1.08	1.82	1.75	2.53
E	-100 to -25	0.43	0.44	0.89	0.56	1.08
	-25 to 350	0.38	0.41	0.77	0.64	1.02
	350 to 650	0.41	0.45	0.84	0.82	1.24
	650 to 1000	0.67	0.73	1.22	1.28	1.81
T	-150 to 0	0.69	0.71	1.51	0.83	1.72
	0 to 120	0.45	0.46	0.95	0.59	1.13
	120 to 400	0.41	0.43	0.82	0.66	1.06
R	250 to 400	0.89	0.91	2.53	1.07	2.71
	400 to 1000	0.93	0.98	2.35	1.37	2.67
	1000 to 1767	1.39	1.48	2.98	2.26	3.78
S	250 to 1000	1.02	1.07	2.69	1.49	2.96
	1000 to 1400	1.23	1.29	2.75	1.87	3.34
	1400 to 1767	1.56	1.65	3.38	2.48	4.24
B	600 to 1200	1.22	1.23	3.64	1.38	3.81
	1200 to 1550	1.18	1.23	2.61	1.64	3.03
	1550 to 1820	1.42	1.48	2.95	2.02	3.49
C	0 to 150	0.73	0.75	1.92	0.87	2.10
	150 to 650	0.70	0.74	1.66	1.09	2.04
	650 to 1000	0.90	0.96	2.01	1.49	2.58
	1000 to 1800	1.74	1.86	3.48	3.00	4.66
	1800 to 2316	2.81	3.03	5.56	5.00	7.60

\*Sensor inaccuracies are not included

Table A-6. Temperature Measurements - Accuracy (Thermocouples) (ITS-90)

Thermocouple		Accuracy ( $\pm$ °C)*				
		18°C to 28°C			0°C to 60°C	
Type (°C)	Temperature (°C)	90 Days Slow	1 Year Slow	1 Year Fast	1 Year Slow	1 Year Fast
J	-100 to -30	0.42	0.43	0.91	0.55	1.08
	-30 to 150	0.37	0.39	0.80	0.57	1.02
	150 to 760	0.44	0.48	0.94	0.88	1.38
K	-100 to -25	0.52	0.53	1.13	0.65	1.31
	-25 to 120	0.43	0.44	0.93	0.62	1.16
	120 to 1000	0.61	0.68	1.38	1.28	2.03
	1000 to 1372	0.89	0.98	1.87	1.85	2.79
N	-100 to -25	0.62	0.63	1.44	0.75	1.61
	-25 to 120	0.53	0.55	1.22	0.67	1.39
	120 to 410	0.47	0.49	1.08	0.69	1.28
	410 to 1300	0.70	0.78	1.52	1.45	2.23
E	-100 to -25	0.44	0.46	0.91	0.57	1.09
	-25 to 350	0.38	0.39	0.77	0.61	0.98
	350 to 650	0.39	0.43	0.82	0.80	1.23
	650 to 1000	0.50	0.56	1.05	1.11	1.63
T	-150 to 0	0.68	0.69	1.50	0.82	1.71
	0 to 120	0.45	0.46	0.95	0.59	1.13
	120 to 400	0.36	0.39	0.78	0.61	1.02
R	250 to 400	0.83	0.85	2.47	1.02	2.66
	400 to 1000	0.79	0.81	2.30	1.15	2.53
	1000 to 1767	0.96	1.05	2.59	1.85	3.42
S	250 to 1000	0.88	0.89	2.60	1.26	2.80
	1000 to 1400	0.83	0.89	2.34	1.47	2.94
	1400 to 1767	1.07	1.17	2.96	2.03	3.84
B	600 to 1200	1.11	1.12	3.53	1.27	3.69
	1200 to 1550	0.74	0.77	2.25	1.18	2.57
	1550 to 1820	0.82	0.89	2.35	1.43	2.90
C	0 to 150	0.72	0.73	1.90	0.86	2.08
	150 to 650	0.62	0.64	1.62	0.99	1.94
	650 to 1000	0.70	0.76	1.81	1.29	2.38
	1000 to 1800	1.12	1.25	2.86	2.38	4.04
	1800 to 2316	1.86	2.08	4.61	4.06	6.66

\* Sensor inaccuracies are not included.

**Input Impedance**

100 MΩ minimum in parallel with 150 pF maximum

**Common Mode and Normal Mode Rejection**

See the specifications for dc voltage measurements.

**Cross-Talk Rejection**

Refer to Appendix B.

**Open Thermocouple Detect**

Small ac signal injection and detection scheme before each measurement detects greater than 1 to 4 kΩ as open. Performed on each channel unless defeated by computer command

**Temperature Measurements (RTDs)**

**Accuracy**

See Table A-7, A-8 and A-9.

**Table A-7. Temperature Measurements - Accuracy (RTDs) (IEC751 Amendment 2) (ITS-90)**

RTD Temperature (°C)	4-Wire Accuracy* (±°C)						
	Resolution		18°C to 28°C			0°C to 60°C	
	Slow	Fast	90 Day Slow	1 Year Slow	1 Year Fast	1 Year Slow	1 Year Fast
-200.00	0.02	0.1	0.05	0.05	0.47	0.06	0.48
0.00	0.02	0.1	0.08	0.09	0.55	0.13	0.59
100.00	0.02	0.1	0.10	0.10	0.58	0.17	0.64
300.00	0.02	0.1	0.13	0.14	0.65	0.24	0.75
600.00	0.02	0.1	0.19	0.20	0.76	0.36	0.92

\* Sensor inaccuracies are not included

**Table A-8. Temperature Measurements - Accuracy (RTDs) (IEC751 Amendment 1) (ITS-90)**

RTD Temperature (°C)	4-Wire Accuracy* (±°C)						
	Resolution		18°C to 28°C			0°C to 60°C	
	Slow	Fast	90 Day Slow	1 Year Slow	1 Year Fast	1 Year Slow	1 Year Fast
-200.00	0.02	0.1	0.11	0.11	0.53	0.12	0.54
0.00	0.02	0.1	0.09	0.09	0.55	0.13	0.59
100.00	0.02	0.1	0.11	0.11	0.59	0.18	0.65
300.00	0.02	0.1	0.19	0.20	0.70	0.30	0.81
600.00	0.02	0.1	0.44	0.45	1.01	0.61	1.17

\* Sensor inaccuracies are not included

Table A-9. Temperature Measurements - Accuracy (RTDs) (IEC751) (IPTS-68)

RTD Temperature (°C)	4-Wire Accuracy* (±°C)						
	Resolution		18°C to 28°C			0°C to 60°C	
	Slow	Fast	90 Day Slow	1 Year Slow	1 Year Fast	1 Year Slow	1 Year Fast
-200.00	0.02	0.1	0.11	0.11	0.53	0.12	0.54
0.00	0.02	0.1	0.09	0.09	0.55	0.13	0.59
100.00	0.02	0.1	0.12	0.12	0.60	0.18	0.66
300.00	0.02	0.1	0.23	0.24	0.74	0.34	0.84
600.00	0.02	0.1	0.56	0.56	1.13	0.73	1.29

\* Sensor inaccuracies are not included

**RTD Type**

DIN/IEC 751, 100Ω Platinum (385)

**2-wire Accuracy**

For 2-wire sensors with R0 = 100Ω: degrade accuracy by 5.0°C per lead-ohm, plus degrade accuracy an additional 11°C for channels 1 to 20 and 0.05°C for channel 0.

**Maximum Current Through Sensor**

1 mA

**Typical Full Scale Voltage**

0.22 V

**Maximum Open Circuit Voltage**

3.2 V

**Maximum Sensor Temperature**

600°C nominal

**Cross-Talk Rejection**

Refer to Appendix B.

**AC Voltage Measurements**

AC voltage measurements are true rms and use ac-coupled inputs.

**Resolution**

See Table A-10.

**Table A-10. AC Voltage Measurements - Resolution**

Range	Resolution		Minimum Input for Rated Accuracy
	Slow	Fast	
300 mV	10 $\mu$ V	100 $\mu$ V	20 mV
3V	100 $\mu$ V	1 mV	200 mV
30V	1 mV	10 mV	2V
150/300V	10 mV	100 mV	20V

**Accuracy**

See Table A-11.

**Table A-11. AC Voltage Measurements - Accuracy**

Range	Frequency	1 Year Accuracy $\pm$ (% $\pm$ V)			
		18°C to 28°C		0°C to 60°C	
		Slow	Fast	Slow	Fast
300 mV	20 Hz - 50 Hz	1.43% + 0.25 mV	1.43% + 0.4 mV	1.54% + 0.25 mV	1.54% + 0.4 mV
	50 Hz - 100 Hz	0.30% + 0.25 mV	0.30% + 0.4 mV	0.41% + 0.25 mV	0.41% + 0.4 mV
	100 Hz - 10 kHz	0.16% + 0.25 mV	0.16% + 0.4 mV	0.27% + 0.25 mV	0.27% + 0.4 mV
	10 kHz - 20 kHz	0.37% + 0.25 mV	0.37% + 0.4 mV	0.68% + 0.25 mV	0.68% + 0.4 mV
	20 kHz - 50 kHz	1.9% + 0.30 mV	1.9% + 0.5 mV	3.0% + 0.30 mV	3.0% + 0.5 mV
	50 kHz - 100 kHz	5.0% + 0.50 mV	5.0% + 1.0 mV	7.0% + 0.50 mV	7.0% + 1.0 mV
3V	20 Hz - 50 Hz	1.42% + 2.5 mV	1.42% + 4 mV	1.53% + 2.5 mV	1.53% + 4 mV
	50 Hz - 100 Hz	0.29% + 2.5 mV	0.29% + 4 mV	0.40% + 2.5 mV	0.40% + 4 mV
	100 Hz - 10 kHz	0.13% + 2.5 mV	0.13% + 4 mV	0.24% + 2.5 mV	0.24% + 4 mV
	10 kHz - 20 kHz	0.22% + 2.5 mV	0.22% + 4 mV	0.35% + 2.5 mV	0.35% + 4 mV
	20 kHz - 50 kHz	0.6% + 3.0 mV	0.6% + 5 mV	0.9% + 3.0 mV	0.9% + 5 mV
	50 kHz - 100 kHz	1.0% + 5.0 mV	1.0% + 10 mV	1.4% + 5.0 mV	1.4% + 10 mV
30V	20 Hz - 50 Hz	1.43% + 25 mV	1.43% + 40 mV	1.58% + 25 mV	1.58% + 40 mV
	50 Hz - 100 Hz	0.29% + 25 mV	0.29% + 40 mV	0.45% + 25 mV	0.45% + 40 mV
	100 Hz - 10 kHz	0.15% + 25 mV	0.15% + 40 mV	0.30% + 25 mV	0.30% + 40 mV
	10 kHz - 20 kHz	0.22% + 25 mV	0.22% + 40 mV	0.40% + 25 mV	0.40% + 40 mV
	20 kHz - 50 kHz	0.9% + 30 mV	0.9% + 50 mV	1.1% + 30 mV	1.1% + 50 mV
	50 kHz - 100 kHz	2.0% + 50 mV	2.0% + 100 mV	2.2% + 50 mV	2.2% + 100 mV
300V	20 Hz - 50 Hz	1.42% + 0.25V	1.42% + 0.4V	1.57% + 0.25V	1.57% + 0.4V
	50 Hz - 100 Hz	0.29% + 0.25V	0.29% + 0.4V	0.44% + 0.25V	0.44% + 0.4V
	100 Hz - 10 kHz	0.14% + 0.25V	0.14% + 0.4V	0.29% + 0.25V	0.29% + 0.4V
	10 kHz - 20 kHz	0.22% + 0.25V	0.22% + 0.4V	0.38% + 0.25V	0.38% + 0.4V
	20 kHz - 50 kHz	0.9% + 0.30V	0.9% + 0.5V	1.0% + 0.30V	1.0% + 0.5V
	50 kHz - 100 kHz	2.5% + 0.50V	2.5% + 1.0V	2.6% + 0.50V	2.6% + 1.0V

### Maximum Voltage Input VS. Frequency Input

See Table A-12.

Table A-12. AC Voltage Measurements

Frequency	Maximum Input at Upper Frequency
20 Hz - 50 Hz	300V rms
50 Hz - 100 Hz	300V rms
100 Hz - 10kHz	200V rms
10 kHz - 20 kHz	100V rms
20 kHz - 50 kHz	40V rms
50 kHz - 100 kHz	20V rms

#### Input Impedance

1 M $\Omega$  in parallel with 100 pF maximum Maximum

#### Maximum Crest Factor

3.0  
2.0 for rated accuracy

#### Crest Factor Error

Non-sinusoidal input signals with crest factors between 2 and 3 and pulse widths 100  $\mu$ s and longer add 0.2% to the accuracy specifications.

#### Common Mode Rejection

80 dB minimum at 50 or 60 Hz  $\pm$  0.1%, 1 k $\Omega$  imbalance, slow rate

#### Maximum AC Input

300V rms or 424V peak on channels 0, 1, and 11  
150V rms or 212V peak on channels 2 to 10 and 12 to 20  
Voltage ratings between channels must not be exceeded

2 x 10<sup>6</sup> Volt-Hertz product on any range, normal mode input

1 x 10<sup>6</sup> Volt-Hertz product on any range, common mode input

#### DC Component Error

SCAN and first MONitor measurements will be incorrect if the dc signal component exceeds 60 counts in slow rate or 10 counts in fast rate. To measure ac with a dc component present, MONitor the input and wait 5 seconds before recording the measurement.

#### Cross-Talk Rejection

Refer to Appendix B.

## Resistance Measurements

### Resolution

See Table A-13.

**Table A-13. Resistance Measurements - Resolution.**

Range	Resolution		Typical Full Scale Voltage	Maximum Current Through Unknown	Maximum Open Circuit Voltage
	Slow	Fast			
300Ω	10 mΩ	0.1Ω	0.22V	1 mA	3.2V
3 kΩ	0.1Ω	1Ω	0.25V	110 μA	1.5V
30 kΩ	1Ω	10 Ω	0.29V	13 μA	1.5V
300 kΩ	10 Ω	100 Ω	0.68V	3.2 μA	3.2V
3 MΩ	100 Ω	1 kΩ	2.25V	3.2 μA	3.2V
10 MΩ	1 kΩ	10 kΩ	2.72V	3.2 μA	3.2V

### Accuracy

See Table A-14.

**Table A-14. Resistance Measurements - Accuracy (Four-Wire)**

Range	4-Wire Accuracy $\pm(\% \pm \Omega)$				
	18°C to 28°C			0°C to 60°C	
	90 Days, Slow	1 Year, Slow	1 Year, Fast	1 Year, Slow	1 Year, Fast
300Ω	0.013% + 20 mΩ	0.014% + 20 mΩ	0.014% + 0.2Ω	0.031% + 20 mΩ	0.031% + 0.2Ω
3 kΩ	0.015% + 0.2Ω	0.016% + 0.2Ω	0.016% + 2Ω	0.039% + 0.2Ω	0.039% + 2Ω
30 kΩ	0.013% + 2Ω	0.014% + 2Ω	0.014% + 20Ω	0.039% + 2Ω	0.039% + 20Ω
300 kΩ	0.020% + 20Ω	0.021% + 20Ω	0.021% + 200Ω	0.050% + 20Ω	0.050% + 200Ω
3 MΩ	0.059% + 200Ω	0.063% + 200Ω	0.063% + 2 kΩ	0.231% + 200Ω	0.231% + 2 kΩ
10 MΩ	0.168% + 2 kΩ	0.169% + 2 kΩ	0.709% + 20 kΩ	0.573% + 2 kΩ	0.923% + 20 kΩ

**2-Wire Accuracy**

Add 4.0Ω to accuracy specifications for channels 1 to 20, and add 20 mΩ for channel 0.  
Lead wire resistances are not included.

300V dc or ac rms on all ranges

**Cross-Talk Rejection**

Refer to Appendix B.

**Frequency Measurements**

**Resolution and Accuracy**

See Table A-15.

**Table A-15. Frequency Measurements-Resolution and Accuracy**

Range	Resolution		Accuracy + (% ± Hz)	
	Slow	Fast	Slow	Fast
15 Hz - 900 Hz	0.01 Hz	0.1 Hz	0.05% + 0.02 Hz	0.05% + 0.2 Hz
9 kHz	0.1 Hz	1 Hz	0.05% + 0.1 Hz	0.05% + 1 Hz
90 kHz	1 Hz	10 Hz	0.05% + 1 Hz	0.05% + 10 Hz
900 kHz	10 Hz	100 Hz	0.05% + 10 Hz	0.05% + 100 Hz
1 MHz	100 Hz	1 kHz	0.05% + 100 Hz	0.05% + 1 kHz

**Frequency Range**

15 Hz to greater than 1 MHz

**Input Sensitivity**

See Table A-16.

**Table A-16. Frequency Measurements - Input Sensitivity**

Frequency	Level (sine wave)
15 Hz - 100 kHz	100 mV rms
100 kHz - 300 kHz	150 mV rms
300 kHz - 1 MHz -	2V rms
Above 1 MHz	Not specified



**Maximum AC Input**

300V rms or 424V peak on channels 0, 1, and 11  
 150V rms or 212V peak on channels 2 to 10 and 12 to 20  
 Voltage ratings between channels must not be exceeded

2 x 10<sup>6</sup> Volt-Hertz product on any range, normal mode input  
 1 x 10<sup>6</sup> Volt-Hertz product on any range, common mode input

**Cross-Talk Rejection**

Refer to Appendix B.

**Typical Scanning Rate**

See table below. The measurement conditions are: averaged rate over 20 scans; continuous scanning; alarm limits and Mx+B scanning set on all channels; logging data to internal memory; and RS-232 communications set at 9600 baud. Measurements were taken with short-circuit inputs on all channels, except frequency, which was taken with 5V at 15 Hz on all channels.

**Table A-17. Typical Scanning Rate**

FUNCTION	RANGE	CHANNELS					
		SLOW			FAST		
		1	10	20	1	10	20
VDC	300 mV	1.8	3.9	4.1	2.5	13.7	18.4
	3V	1.8	3.9	4.1	2.5	13.7	18.4
	30V	1.8	3.9	4.1	2.5	13.7	18.3
	150/300V	1.8	3.9	4.1	2.5	13.6	18.2
	AUTO	1.7	3.6	3.9	2.4	11.3	14.1
TEMPERATURE	J (TC)	1.0	3.3	3.8	2.1	12.2	16.6
	PT (RTD)	1.7	3.1	3.2	2.1	6.0	6.7
VAC	300 mV	1.1	1.5	1.6	1.3	2.5	2.6
	3V	1.1	1.5	1.6	1.3	2.5	2.6
	30V	1.1	1.5	1.6	1.3	2.5	2.6
	150/300V	1.1	1.5	1.6	1.3	2.5	2.6
	AUTO	1.1	1.5	1.5	1.3	2.4	2.5
OHMS	300Ω	1.7	3.1	3.2	2.1	6.0	6.7
	3 kΩ	1.7	3.1	3.2	2.1	6.0	6.7
	30 kΩ	1.7	3.1	3.2	2.1	6.0	6.7
	300 kΩ	1.2	1.8	1.8	1.7	4.0	4.4
	3 MΩ	1.2	1.6	1.7	1.7	3.9	4.2
	10 MΩ	1.1	1.6	1.6	1.7	3.8	4.0
	AUTO	1.7	3.1	3.2	2.1	6.0	6.7
FREQUENCY	ANY	0.5	0.6	0.6	0.6	0.7	0.7

## Maximum Autoranging Time

See Table A-18 (shown in seconds per channel).

## Totalizing Input

### Input Voltage

30V maximum

4V minimum

2V peak minimum signal

### Isolation

None

dc-coupled

Table A-18. Autoranging Rates

Function	Range Change		Slow	Fast
VDC	300 mV	-----> 150 V	0.25	0.19
	150V	-----> 300 mV	0.25	0.18
VAC	300 mV	-----> 150V	1.40	1.10
	150 mV	-----> 300 mV	1.40	1.10
Ohms	300 Ω	-----> 10.0 MΩ	1.70	0.75
	10.0 MΩ	-----> 300 Ω	1.50	0.60

### Threshold

1.4V

### Hysteresis

500 mV

### Input Debouncing

None or 1.75 ms

### Rate

0 to 5 kHz with debouncing off

### Maximum Count

65,535

## Digital Inputs

The specifications for the digital inputs are provided in the following paragraphs.

**Input Voltage**

30V maximum

-4V minimum

**Isolation**

none

dc-coupled

**Threshold**

1.4V

**Hysteresis**

500 mV

**Trigger Inputs****Input Voltages**

contact closure and TTL compatible

“high” = 2.0V min, 7.0V max

“low” = -0.6V min, 0.8V max

**Isolation**

None

dc-coupled

**Minimum Pulse Width**5  $\mu$ s**Maximum Frequency**

5 Hz

**Specified Conditions**

The instrument must be in the quiescent state, with no interval scans in process, no commands in the queue, no RS-232 activity, and no front panel activity if the latency and repeatability performance is to be achieved.

**Maximum Latency**

Latency is measured from the edge of the trigger input to the start of the first channel measurement for the Specified Conditions (above).

540 ms for fast rate, scanning DCV, ACV, ohms, and frequency only

610 ms for fast rate, scanning any thermocouple or 100 mV dc channels

500 ms for slow rate, scanning DCV, ACV, ohms, and frequency only

950 ms for slow rate, scanning any thermocouple or 100 mV dc channels

**Repeatability**

3 ms for the Specified Conditions (above)

## **Digital and Alarm Outputs**

The specifications for the digital and alarm outputs are provided in the following paragraphs.

### **Output Logic Levels**

Logical “zero”: 0.8V max for an I<sub>out</sub> of -1.0 mA (1LSTTL load)  
Logical “one”: 3.8V min for an I<sub>out</sub> of 0.05 mA (1LSTTL load)

For non-TTL loads: 1.8V max for an I<sub>out</sub> or -20 mA  
Logical “zero”: 3.25 max for an I<sub>out</sub> of -50 mA

### **Isolation**

none

## **Real-Time Clock and Calendar**

The specifications for the real-time clock and calendar are provided in the following paragraphs.

### **Accuracy**

Within 1 minute per month for 0°C to 50°C range

### **Battery Life**

>10 unpowered instrument years for 0°C to 28°C  
>3 unpowered instrument years for 0°C to 50°C  
>2 unpowered instrument years for 50°C to 70°C

## **Environmental Specifications**

The environmental specifications are provided in the following paragraphs.

### **Warmup Time**

1 hour to rated specifications

15 minutes when relative humidity is kept below the rated maximum minus 20% (e.g. below 70% for a 90% maximum rating).

### **Operating Temperature**

0°C to 60°C

### **Storage Temperature**

-40°C to +75°C

Instrument storage at temperature extremes may necessitate adding up to 0.008% to the dc and ac voltage accuracy specifications. Alternatively, any resulting shift can be compensated for by recalibrating the instrument.

**Relative Humidity (Non-Condensing)**

90% maximum for 0°C to 28°C  
75% maximum for 28°C to 35°C  
50% maximum for 35°C to 50°C  
35% maximum for 50°C to 60°C  
(Except 70% maximum for 0°C to 35°C, 0% maximum for 40°C to 50°C, and 20% maximum for 50°C to 60°C for the 300 k $\Omega$ , 3 M $\Omega$ , and 10 M $\Omega$  ranges.)

**Altitude**

Operating: 2,000 m maximum  
Non-operating: 12,200m maximum

**Vibration**

0.7g at 15 Hz  
1.3g at 25 Hz  
3g at 55 Hz

**Shock**

30g half sine per Mil-T-28800  
Bench handling per Mil-T-28800

**General**

The general specifications are provided in the following paragraphs.

**Channel Capacity**

21 Analog Inputs  
4 Alarm Outputs  
8 Digital I/O (inputs/outputs)

**Measurement Speed**

Slow rate: 4 readings/second nominal  
Fast rate: 17 readings/second nominal

1.5 readings/second nominal for ACV and high- $\Omega$  inputs

For additional information, refer to Typical Scanning Rate and Maximum Autoranging Time.

**Nonvolatile Memory Life**

>10 unpowered instrument years for 0°C to 28°C  
>3 unpowered instrument years for 0°C to 50°C  
>2 unpowered instrument years for 50°C to 70°C  
Stores: Real-time clock, set-up configuration, and measurement data.

**Common Mode Voltage**

300V dc or ac rms maximum from any analog input (channel) to earth provided that channel to channel maximum voltage ratings are observed.

### **Voltage Ratings**

Channels 0,1, and 11 are rated at 300V dc or ac rms maximum from a channel terminal to earth and from a channel terminal to any other channel terminal.

Channels 2 to 10 and 12 to 20 are rated at 150V dc or ac rms maximum from a channel terminal to any other channel terminal within channels 2 to 10 and 12 to 20.

IEC Overvoltage Category II.

### **Size**

9.3 cm high, 21.6 cm wide, 31.2 cm deep

### **Weight**

Net, 2.95 kg

Shipping, 4.0 kg

### **Power**

90V to 264V ac (no switching required), 50 and 60 Hz, 10 VA maximum

9V dc to 16V dc, 10W maximum

If both sources are applied simultaneously, ac is used if it exceeds approximately 8.3 times dc.

Automatic switchover occurs between ac and dc without interruption.

(At 120V ac the equivalent dc voltage is ~14.5V).

### **Standards**

IEC 1010-1, ANSI/ISA S82.01-1994, CSA-C22.2 No.1010.1-92, and EN61010-1:1993.

Complies with EN 50081-1, EN 50082-1, Vfg. 243/1991 and FCC-15B at the Class B level, when shielded cables are used.

### **RS-232-C**

Connector:	9 pin male (DB-9P)
Signals:	TX, RX, DTR, DSR, RTS, CTS, GND
Modem Control:	full duplex
Baud rates:	300, 600, 1200, 2400, 4800, 9600, 19200, 38400
Data format:	8 data bits, no parity bit, one stop bit, or 7 data bits, one parity bit (odd or even), one stop bit
Flow control:	CTS (Hardware) and XON/XOFF (Software)
Echo:	on/off

# **Appendix B**

## **Crosstalk Considerations**

### **Introduction**

This appendix augments the discussion of ac signal effects on other channels (crosstalk). Effects on each measurement function are discussed below. These numbers should only be considered as references. Since cross talk can be introduced into a measurement system in many places, each setup must be considered individually.

The effect of cross talk could be much better than shown for "Typical"; in extreme cases, the effect could be worse than the "Worst Case" numbers. In general, the "Worst Case" information assumes that none of the guidelines for minimizing cross talk (Chapter 1) have been followed; the "Typical" information assumes that the guidelines have been followed where reasonable.

These numbers assume that input L (low) is tied to earth ground; refer to "Using Shielded Wiring" in Chapter 1. For dc volts and thermocouple temperature measurements, a source impedance of 1 k $\Omega$  in series with the H (high) input is assumed (except where otherwise noted.)

### **AC Signal Cross Talk in a DC Voltage Channel**

$$\text{DCV Error Ratio (CTRR)} = \left[ \frac{VDC(error)}{VACrms} \right]$$

Worst case	Typical		
50, 60 Hz, $\pm 0.1\%$ :		$1.1 \times 10^{-7}$	$2.0 \times 10^{-8}$
Other Frequencies:		$3.8 \times 10^{-6}$	$8.6 \times 10^{-7}$

For example, the typical effect on a channel measuring dc volts (300 mV range) by a 300 V ac signal at 60 Hz on another channel would be:  $300 \times 2.0 \times 10^{-8} = 0.01$  mV.

## AC Signal Cross Talk into an AC Voltage Channel

$$\text{ACV Error Ratio} = \left[ \frac{VACrms(error)}{VACrms(crosstalk) \times Frequency(crosstalk)} \right]$$

<u>Range</u>	<u>Ratio (worst case)</u>	<u>Ratio (typical)</u>
300.00 m	$4.8 \times 10^{-8} \left[ \frac{v}{v \times Hz} \right]$	$1.4 \times 10^{-8} \left[ \frac{v}{v \times Hz} \right]$
3.0000 V	$1.1 \times 10^{-7} \left[ \frac{v}{v \times Hz} \right]$	$3.0 \times 10^{-8} \left[ \frac{v}{v \times Hz} \right]$
30.000 V	$1.2 \times 10^{-6} \left[ \frac{v}{v \times Hz} \right]$	$2.6 \times 10^{-7} \left[ \frac{v}{v \times Hz} \right]$
150.00/300.00	$1.2 \times 10^{-5} \left[ \frac{v}{v \times Hz} \right]$	$3.4 \times 10^{-6} \left[ \frac{v}{v \times Hz} \right]$

For example, the typical effect on a channel measuring ac volts (300 mV range) by a 220V ac signal at 60 Hz on another channel would be:  $220 \times 60 \times 1.4 \times 10^{-8} = 0.18 \text{ mV}$ .

## AC Signal Cross Talk into an Ohms Channel

AC Frequency = 50, 60 Hz,  $\pm 0.1\%$

$$\text{OHMS Error Ratio}^1 = \left[ \frac{Ohms(error)}{VACrms(crosstalk)} \right]$$

<u>Range</u>	<u>Ratio (worst case)</u>	<u>Ratio (typical)</u>
300.00 $\Omega$	$3.3 \times 10^{-5} \left[ \frac{Ohms}{Vrms} \right]$	NoEffect
3.0000 k $\Omega$	$2.4 \times 10^{-6} \left[ \frac{kOhms}{Vrms} \right]$	$6.7 \times 10^{-7} \left[ \frac{kOhms}{Vrms} \right]$
30.000k $\Omega$	$3.1 \times 10^{-4} \left[ \frac{kOhms}{Vrms} \right]$	$8.4 \times 10^{-5} \left[ \frac{kOhms}{Vrms} \right]$
300.00 k $\Omega$	$5.6 \times 10^{-3} \left[ \frac{kOhms}{Vrms} \right]$	$3.7 \times 10^{-3} \left[ \frac{kOhms}{Vrms} \right]$
3.0000 M $\Omega$	$3.8 \times 10^{-4} \left[ \frac{MOhms}{Vrms} \right]$	$3.8 \times 10^{-5} \left[ \frac{MOhms}{Vrms} \right]$



$$10.000 \text{ M}\Omega \qquad 1.4 \times 10^{-3} \left[ \frac{\text{M}\Omega}{V_{\text{rms}}} \right] \qquad 4.3 \times 10^{-4} \left[ \frac{\text{M}\Omega}{V_{\text{rms}}} \right]$$

For example, to find the typical effect of a 60 Hz, 100V ac signal on another channel for the 30 kΩ range, you would calculate: 100 X 8.4 X 10<sup>-5</sup> = 0.008 kΩ.

<sup>1</sup>These values assume no more than 1000 pf of capacitance between either end of the resistor (HI and LOW ) and earth ground.

### ***AC Signal Cross Talk into a Frequency Channel***

Frequency measurements are unaffected by cross talk as long as the voltage-frequency product is kept below the following limits:

<u>Worst Case</u>	<u>Typical</u>	
<i>V x Hz Product Limit</i>	$3.7 \times 10^4 (V \times \text{Hz})$	$1.0 \times 10^6 (V \times \text{Hz})$

### ***AC Signal Crosstalk into a Temperature Channel***

Frequency = 50, 60 Hz

$$\text{TEMPERATURE Error Ratio} = \left[ \frac{^{\circ}\text{C}(\text{error})}{VAC_{\text{rms}}(\text{crosstalk})} \right]$$

	<u>Worst case</u>	<u>Typical</u>
Types J, K, E, T, N:	$2.7 \times 10^{-3} \left[ \frac{^{\circ}\text{C}}{V_{\text{rms}}} \right]$	$5.0 \times 10^{-4} \left[ \frac{^{\circ}\text{C}}{V_{\text{rms}}} \right]$
Types R, S, B, C:	$1.1 \times 10^{-2} \left[ \frac{^{\circ}\text{C}}{V_{\text{rms}}} \right]$	$2.0 \times 10^{-3} \left[ \frac{^{\circ}\text{C}}{V_{\text{rms}}} \right]$
Type PT (RTD):	$8.6 \times 10^{-5} \left[ \frac{^{\circ}\text{C}}{V_{\text{rms}}} \right]$	<i>No Effect</i>



# **Appendix C**

## **Binary Upload of Logged Data**

### **Introduction**

The LOG\_BIN? <index> query can be used to quickly upload logged data from a 2635A. The response is a single ASCII string, which encodes the raw binary data stored at the specified <index> position. The logged data is also retained in the 2635A.

The measurement data returned from the 2635A is in the (binary) IEEE single-precision floating point format. Making use of this data can be difficult and is very machine dependent. A working example, using the C programming language on an IBM PC, is provided in this appendix. This example uses a pre-computed LOG\_BIN?response string, and checks that the conversion process works as expected.

Two steps are required in adapting the LOG\_BIN? response string for use with your computer.

- First, you must decode the ASCII string into binary data.

For example, one possible LOG\_BIN? response string is:

LOG\_BIN? 1

42@Y40BA00oo000007o0001oP000?h000

=>

This ASCII string represents the following binary (hex) data:

10 24 29 10 04 91 00 0f ff

00 00 00 00 7f c0 00 00 7f

80 00 00 3f 80 00 00 00 00

- Second, you must convert this binary data into valid floating point numbers for your underlying computer architecture.

### **Decoding the ASCII String**

The ASCII response string contains six bits of raw data for each ASCII character, offset from ASCII '0' (0x30 hex, 48 decimal). Therefore, the conversion process subtracts 48 from the integer value of each character, then shifts it into place. Each set of four ASCII characters form three bytes of raw data. The number of bytes of raw data depends on the

number of channels for the scan. The following C code converts a LOG\_BIN? response string into a byte array:

```

/*
- * decode(): Decode LOG_BIN? response string into raw byte stream
**
** Decoding is done on multiples of four input bytes:
**
**          543210   543210   543210   543210   (bit number in ASCII bytes)
**          +-----+-----+-----+-----+
**          | src[0] | src[1] | src[2] | src[3] |   ASCII string input
**          +-----+-----+-----+-----+
**          765432   107654   321076   543210   (bit number in raw bytes)
**          /         /         /
**          /         /         /
**          |         |         |
**          |         |         |
**          |         |         |
**          76543210 76543210 76543210           (bit number in raw bytes)
**          +-----+-----+-----+
**          | dst[0] | dst[1] | dst[2] |         Raw data output
**          +-----+-----+-----+
**
** Inputs:
**   dst   Destination for binary data (must have enough space
**         allocated; the maximum needed is 6 timestamp bytes + 3
**         bytes for temp units, measurement rate, and digital I/O
**         + 4 bytes/float * 22 floating point values = 97 bytes).
**
**   src   Source ASCII string (null terminated)
**
** Outputs:
**   dst   Set to binary data, based on ASCII string
**
** Returns:
**   Number of bytes placed in destination buffer
*/

int
decode(dst, src)
    unsigned char *dst;
    char *src;
{
    /* src to dst xlate */
    static struct nibtab_s {
        int lindex;
        int lmask;
        int lshift;
        int rindex;
        int rmask;
        int rshift;
    } nibtab[3] = {
        /* left           right */

```

```

    0, 0x3f, 2,    1, 0x30, 4,    /* dst[0] from src[0] and src[1] */
    1, 0x0f, 4,    2, 0x3c, 2,    /* dst[1] from src[1] and src[2] */
    2, 0x03, 6,    3, 0x3f, 0,    /* dst[2] from src[2] and src[3] */
};

auto unsigned char n;
auto struct nibtab_s *t;
auto unsigned char tmpsrc[4];
auto int dst_bytes;

/* Number of bytes created */
dst_bytes = 0;

/* Process src in chunks of four */
while (*src) {

    /* Copy source, filling "holes" at end with zeros */
    for (n = 0; n < 4; n++) {
        if (*src)
            tmpsrc[n] = *src++ - '0';
        else
            tmpsrc[n] = 0;
    }

    /* Mung source into destination */
    for (t = nibtab; t < &nibtab[3]; t++) {

        *dst = (tmpsrc[t->lindex] & t->lmask) << t->lshift;
        *dst |= (tmpsrc[t->rindex] & t->rmask) >> t->rshift;

        dst++;
        dst_bytes++;
    }
}

return (dst_bytes);
}

```

**Figure C-1. ASCII String Decoding**

The raw data output array contains the information listed below. Note that the number of floating point values is equal to the number of channels in use, plus one. (The totalizer count is always present in the data, and is stored as a floating point number.)

- Time stamp (BCD format)
  - byte0: hours
  - byte1: minutes
  - byte2: seconds
  - byte3: month
  - byte4: date
  - byte5: year
- Temperature units, measurement rate, and I/O

byte6: temperature units and rate (0x10 bit means degrees Fahrenheit, else Centigrade; 0x01 bit means fast rate, else slow rate)

byte7: Alarm outputs

byte8: Digital I/O

- Totalizer value as 32-bit single-precision IEEE floating point number stored using the byte ordering shown below. The format of this number is explained under "Floating Point Conversion".

byte 9: MMSB of float

byte 10: MLSB of float

byte 11: LMSB of float

byte 12: LLSB of float

- Measurement data; only defined channels are included (exactly like LOG?query); same floating point format, but with a wider range of values. NaN (Not a Number) is used to indicate open thermocouple, and plus or minus Inf (infinity) to indicate overload. The bit values for NaN and Inf are explained in the next section.

byte 13: MMSB of float

byte 14: MLSB of float

byte 15: LMSB of float

byte 16: LLSB of float

bytes 17-20: Second measurement result, if any

bytes 21-24: Third measurement result, if any

...

Since the ASCII decoding (explained above) creates data multiples of three in length, it is possible that there will be one or two unused bytes at the end of the decoded byte stream.

## ***Floating Point Conversion***

ANSI/IEEE Std 754-1985, "IEEE Standard for Binary Floating-Point Arithmetic," describes the single-precision floating point format used to return measurement data. This standard defines the format for single-precision floating point as:

$$X = (-1)^s 2^{(e-127)} (1.m)$$

where

s = sign

e = exponent

m = mantissa

The floating point format used is 32-bit with a 1-bit sign, 8-bit exponent, and 24-bit mantissa with the most significant bit hidden under the LSB of the exponent. The number is formatted as shown in Table C-1.

For all other measurement queries, Hydra Series II returns the string "+9E+9" for open thermocouple (OTC) measurement values. However, for the LOG\_BIN?query, NaN (not a number) is returned instead. The IEEE floating point standard defines NaN as a positive, maximum exponent number with non-zero mantissa bits. Hydra Series II sets

just the most significant mantissa bit, so the raw binary byte stream value is 7f c0 00 00 (hex).

For all other measurement queries, Hydra Series II usually returns  $\pm 1e9$  for overload (OL) measurement values. However, for the LOG\_BIN? query, Hydra Series II returns Inf (infinity) instead. The IEEE floating point standard defines Inf as a positive or negative maximum exponent number with a zero mantissa. Hydra Series II returns +Inf as the byte stream 7f 80 00 00 (hex) and -Inf as ff 80 00 00 (hex).

**Table C-1. Floating-Point Format**

<b>Sign</b> 1 bit	<b>Exponent</b> 8 bits	<b>Manitssa</b> 23 bits (plus one hidden bit)	
high byte (MMSB)	High-mid byte (MLSB)	low-mid bute (LMSB)	low byte (LLSB)

The C code in Figure C-2 converts raw data into a useful format for the Intel x86 (IBM PC) architecture. The BCD time stamp is converted to integers, and floating point numbers created for the totalizer and measurement values.

```
/* Import globals from main program */
extern int timestamp[];
extern int misc[];
extern float values[];

/*
*- convert(): Convert a LOG_BIN? array of binary data into useful data
**
** Converts BCD values to integer, raw floating point values into float
** values usable under the Intel x86 (IBM PC) architecture.
**
** Inputs:
**     src           Array of binary data, from LOG_BIN? query
**     length        Number of bytes in src array
**
** Outputs:
**     timestamp[]   Set to decimal timestamp values
**     misc[]         Set to temp units, rate, and digital I/O values
**     values[]       Set to floating point values found in binary data
**                   (must be room for a maximum of 22 floats)
*/

void
convert(src, length)
    unsigned char *src;
    int length;
{
    unsigned char *m;
    int n;

    /* Convert timestamp from BCD to decimal */
    for (n=0; n < 6; n++, src++) {
        /* Binary Coded Decimal (BCD) format, packs the upper nibble as the
*/
        /* tens digit, the lower nibble as the ones digit. Convert this
*/
        /* into an integer number.
*/
        timestamp[n] = (10 * (*src >> 4) + (*src & 0x0f));
    }

    /* Save temperature units, measurement rate, and digital I/O values */
    for (n=0; n < 3; n++) {
        misc[n] = *src++;
    }

    /* Convert raw measurement data into floating point */
    m = (unsigned char *)values;
    for (length -= 9; length > 3; length -= 4) {
#ifdef sun
        /* SunOS architecture (also works for Motorola CPUs) */
        *m++ = src[0];
        *m++ = src[1];
        *m++ = src[2];
        *m++ = src[3];
#else
        /* Assume Intel x86 architecture */
        *m++ = src[3];
        *m++ = src[2];
        *m++ = src[1];
        *m++ = src[0];
#endif
        src += 4;
    }
}
```

Figure C-2. Floating\_Point Conversion



## **Example**

Figure C-3 is a short example that uses the routines in Figures C-1 and C-2 to decode a fixed (pre-computed) LOG\_BIN? response string.

When compiled and run on an Intel architecture computer, the program should print "Conversion worked".

Although this example is useful for educational purposes, it is not very efficient. If desired, the decoding and conversion processes can be combined into a single, fast algorithm.

```

/* Globals convert() uses for destination */
int timestamp[6];      /* Scan timestamp */
int misc[3];          /* Temperature units, measurement rate, digital I/O */
float values[22];     /* Measurement values */

extern int isnan();    /* Floating point value is NaN (not a number) */
extern int isinf();   /* Floating point value is Inf (infinity) */

/*
-* main(): LOG_BIN? query response example program
**
** Converts a hard-coded LOG_BIN? response string into usable data.
*/
main()
{
    extern int decode();      /* ASCII to binary decoding */
    extern void convert();   /* Convert Hydra binary to usable types */

    /* Canned response for three channels: channel 1 is OTC, channel 5 is */
    /* OL and channel 10 is 1.0; remaining encoded data described below */
    /* (note that you can not determine the channel number, measurement */
    /* units, or measurement range, from this string; you must keep track */
    /* of that elsewhere) */
    char *log_bin_response = "42@Y40BA00o000007o0001oP000?h000";

    /* Place to temporarily store raw data; 100 bytes is more than enough */
    /* for any LOG_BIN? response string */
    unsigned char raw_data[100];

    /* Decode string into raw data, then convert raw data into usable data */
    convert(raw_data, decode(raw_data, log_bin_response));

    /* Above global variables now usable; check example LOG_BIN? data */
    /* against expected values */

    if ((timestamp[0] == 10) &&          /* Hours          */
        (timestamp[1] == 24) &&          /* Minutes        */
        (timestamp[2] == 29) &&          /* Seconds        */
        (timestamp[3] == 10) &&          /* Month          */
        (timestamp[4] == 4) &&           /* Day            */
        (timestamp[5] == 91) &&          /* Year           */
        (misc[0] == 0) &&                /* Temp units and rate */
        (misc[1] == 15) &&                /* Alarm outputs    */
        (misc[2] == 255) &&               /* Digital I/O     */
        (values[0] == 0.0) &&            /* Totalizer       */
        isnan(values[1]) &&              /* Channel 1 data  */
        isinf(values[2]) &&              /* Channel 5 data  */
        (values[3] == 1.0)) {           /* Channel 10 data */

        printf("Conversion worked\n");
    }
    else {
        printf("ERROR: conversion did not succeed!\n");
    }

    exit(0);
}

/* If your math library supplies alternatives to isnan() or isinf(), */
/* use them instead! */

int
isnan(f)
float f;
{
    /* This is not portable, or completely accurate (since NaN mantissa */
    /* must only be non-zero, and the sign bit can be set), but this works */
    /* for NaN values returned by Hydra */

    /* Compiler was free to promote to double */
    float ff = f;

    return ((*((unsigned long *)&ff) == 0x7fc00000L);
}

int
isinf(f)
float f;
{
    /* Again, this is not portable, but this time it is accurate */

    /* Compiler was free to promote to double */
    float ff = f;

    return ((*((unsigned long *)&ff) == 0x7f800000L) ||
            ((*((unsigned long *)&ff) == 0xff800000L);
}

```

Figure C-3. Example

# Appendix D

## RS-232 Cabling

### Introduction

This appendix details the RS-232 cabling between the instrument and a PC, instrument controller (Fluke 17XXA series), printer, or modem. All connections can be made using the Fluke RS-series of cables (see Options and Accessories in Chapter 1). RS-232 cables should not exceed 50 feet (15 meters) although longer cables are permitted if the load capacitance measured at a connection point (including signal terminator) does not exceed 2500 picofarads. The Fluke RS cables are 6 feet (1.83 meters) in length.

### Connections

Figure D-1 summarizes the cable requirements for all typical RS-232 connections; Figure D-2 through E-6 summarize instrument cabling diagrams; Figure D-7 shows the pin arrangement for DB-9 and DB-25 connectors. There are two wiring schemes (modem and null-modem), two types of connectors (DB-9 and DB-25), two cable end conditions (male and female), and two equipment configurations (Data Terminal Equipment [DTE] and Data Communications Equipment [DCE]). Because of variations in RS-232 connectors, it is not possible to identify all possible configurations. In this application, “null-modem” refers to a reversing of the following lines; receive (RX) and transmit (TX), data terminal ready (DTR) and data set ready (DSR), and request to send (RTS) and clear to send (CTS). Not all interfaces use all lines. Check the documentation for the equipment you are interfacing with the instrument.

### Cables

The Fluke RS-series of RS-232 cables are in the following standard configurations:

- RS40 - Null modem with DB-9/female and DB-25/female connectors
- RS41 - Modem with DB-9/female and DB-25/male connectors
- RS42 - Null modem with DB-9/female and DB-25/male connectors

Cables from other sources may be used, or cables can be fabricated based on the figures in this appendix. The RS40 and RS42 cables are identical, except for the DB-25 connectors (female and male, respectively). Some interfaces allow a selection of cables.

For example, connection to a serial-to-parallel converter (when using a printer with a parallel input) may be as a DTE (cable RS42) or DCE (cable RS40).

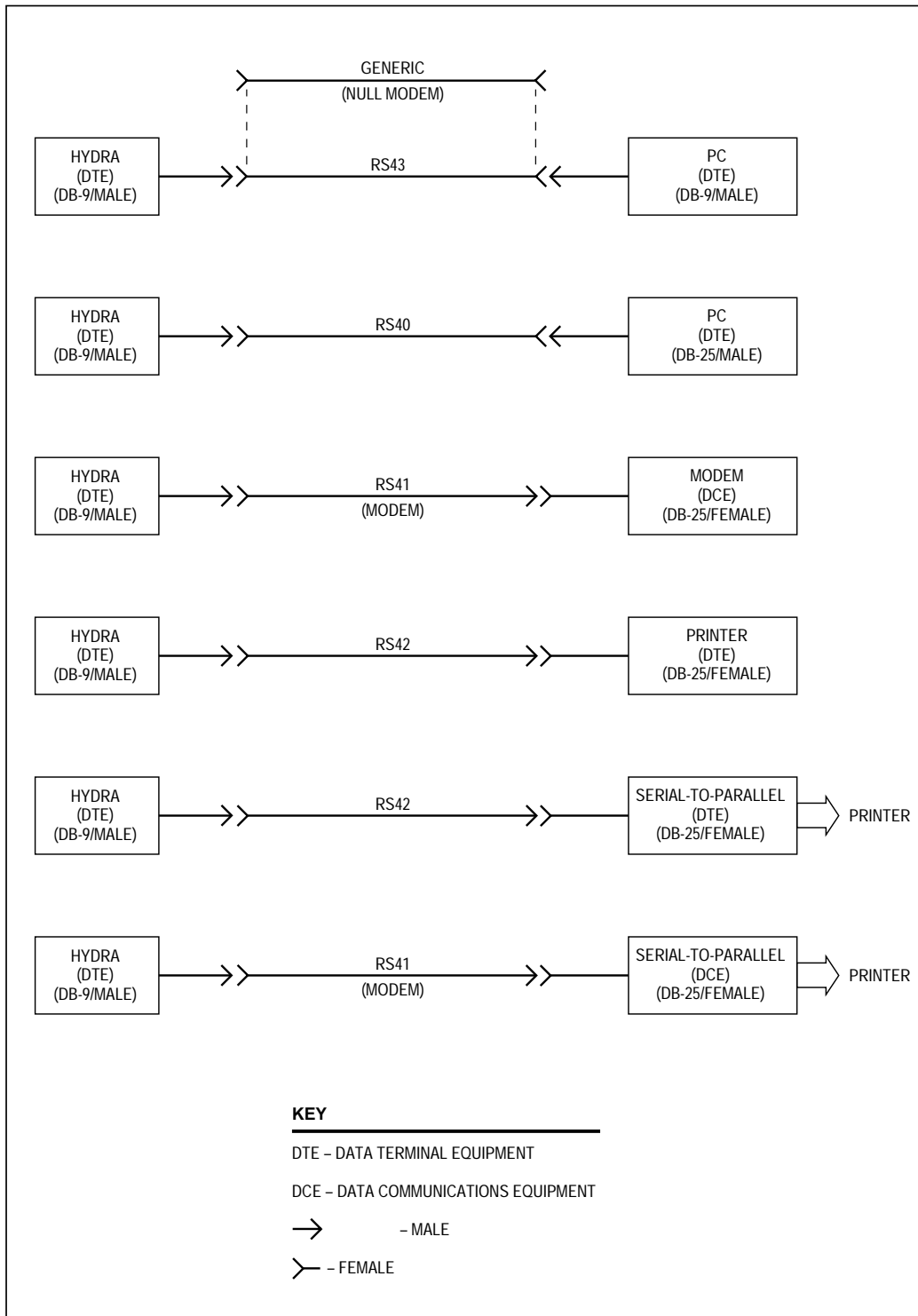

op71f.eps

**Figure D-1. Summary of RS-232 Connections**

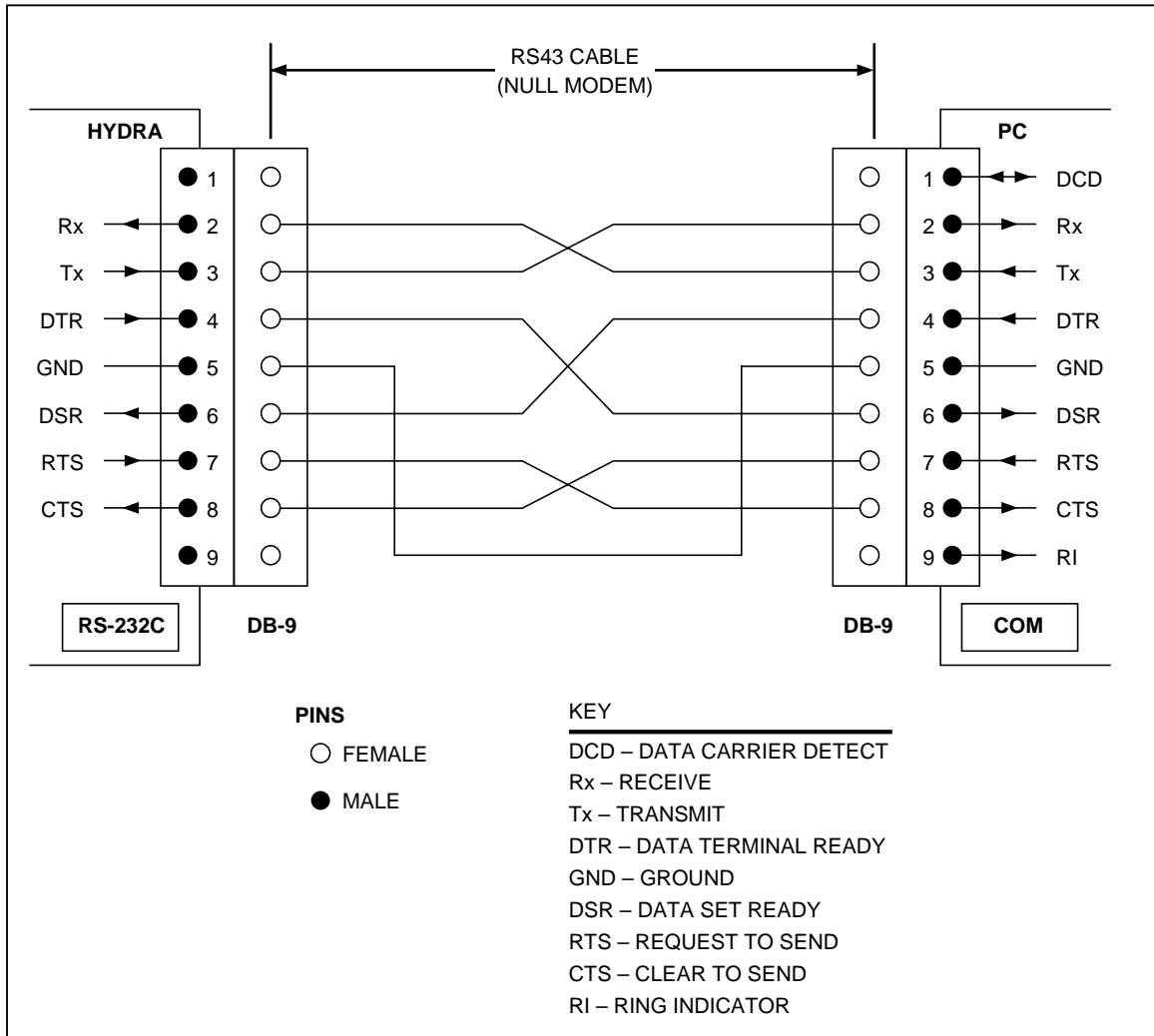

op73f.eps

Figure D-2. Hydra Series II (DB-9) to PC (DB-9) RS-232 Connection (Generic)

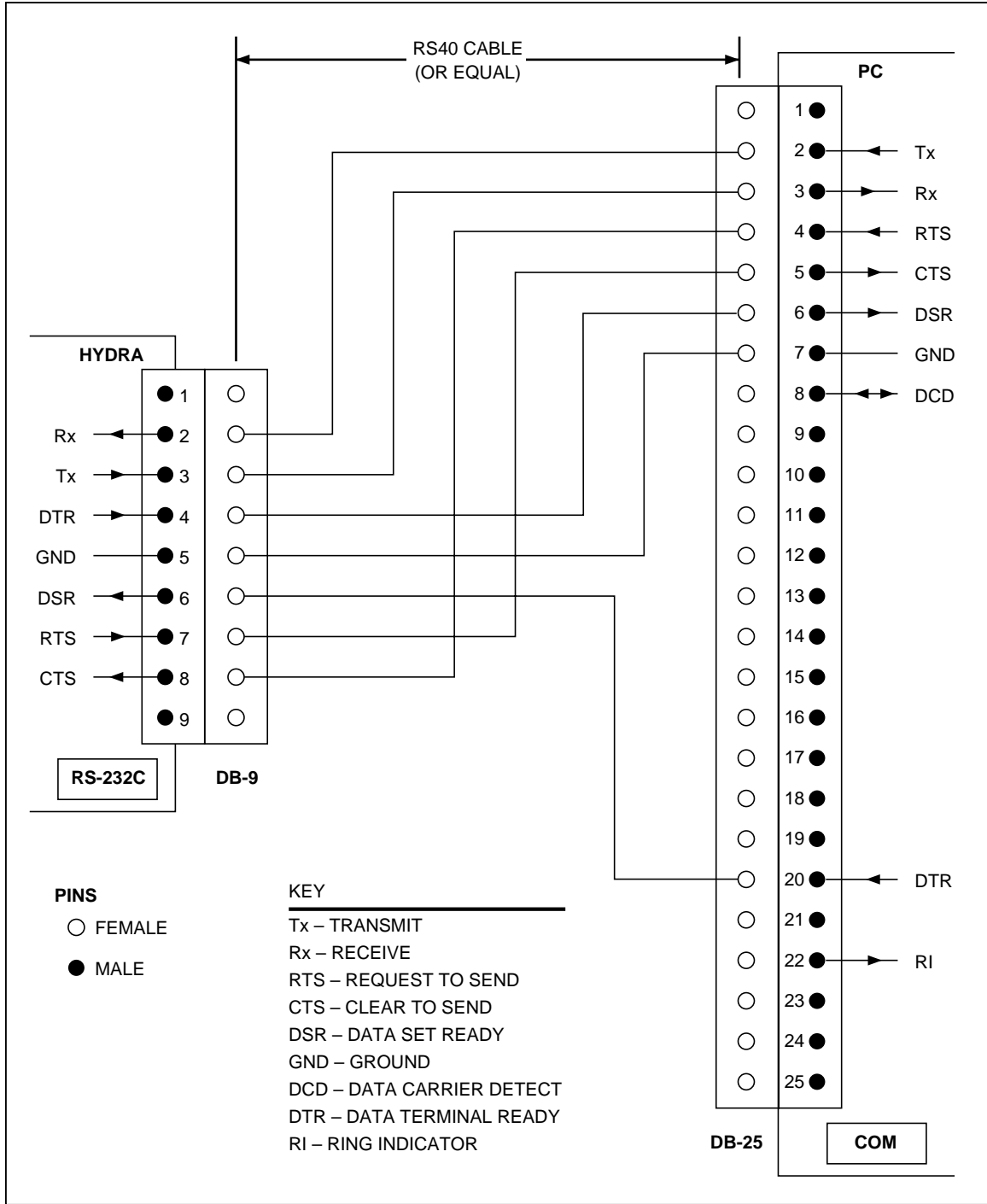

op74f.eps

Figure D-3. Hydra (DB-9) to PC (DB-25) RS-232 Connection

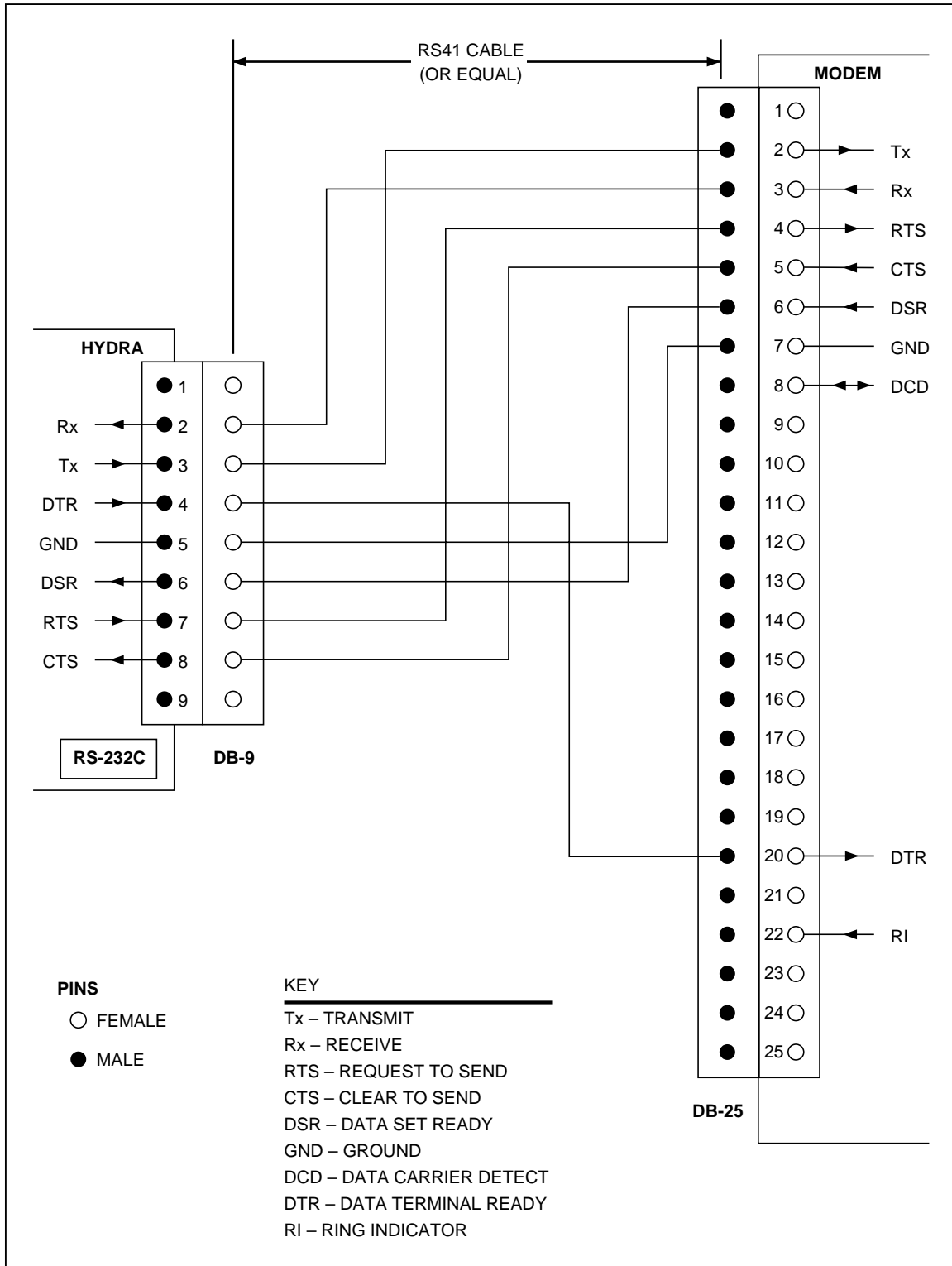

op75f.eps

Figure D-4. Hydra Series II (DB-9 to Modem (DB-25) RS-232 Connection

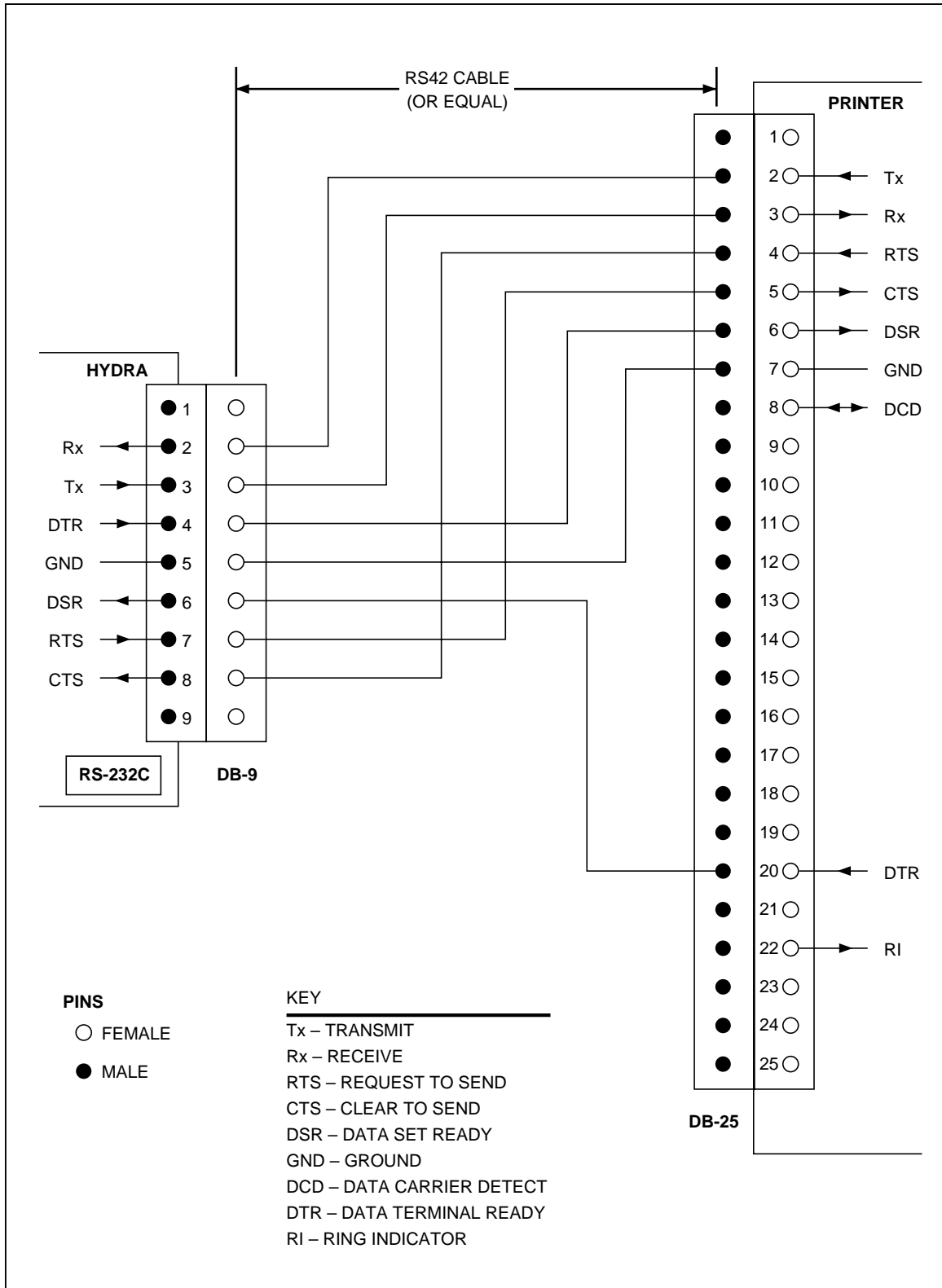

Figure D-5. Hydra Series II (DB-9) to Printer (DB-25) RS-232 Connection

op76f.eps



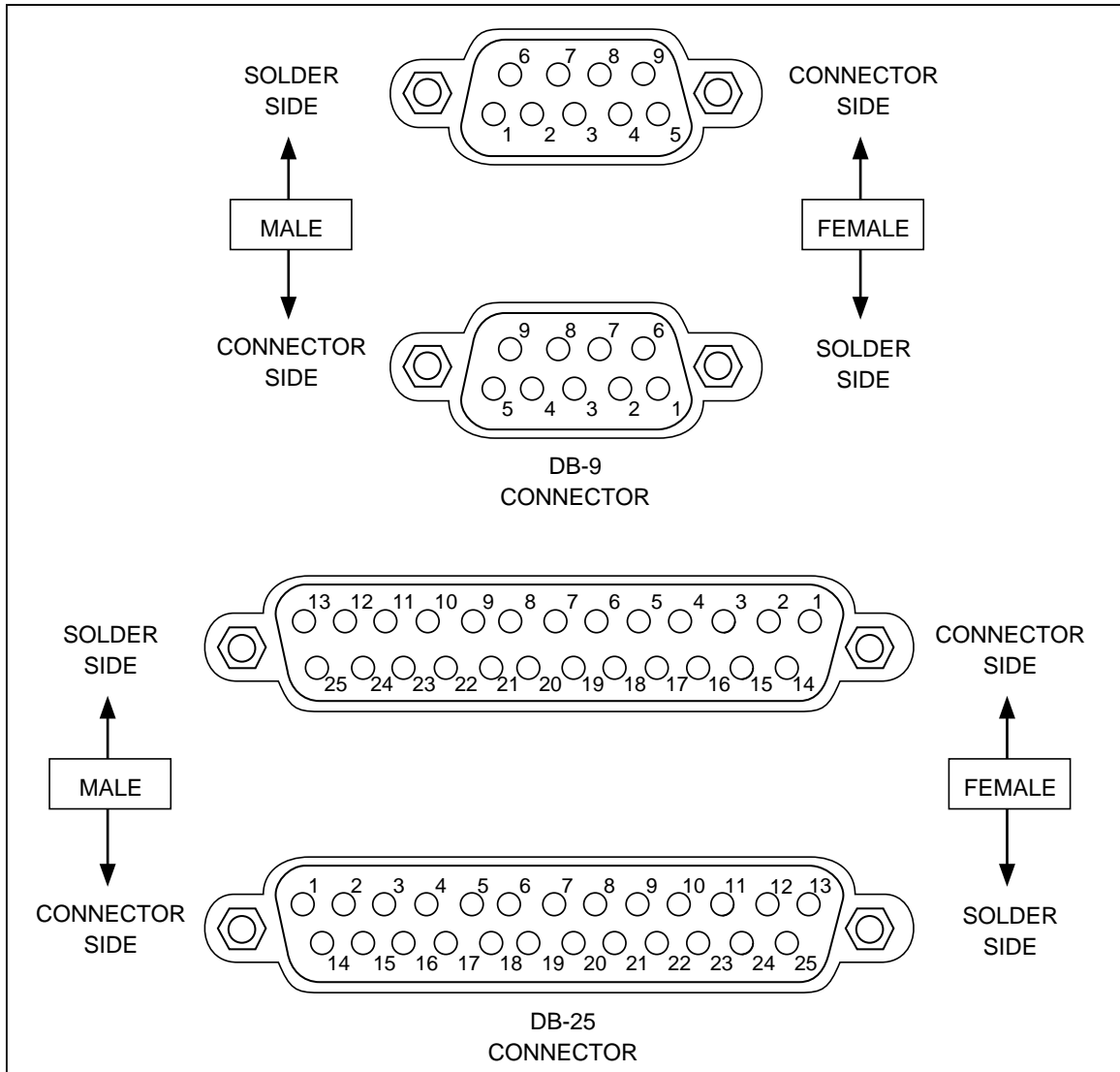

Figure D-6. RS-232 DB-9 and DB-25 Connectors

op77f.eps



***Appendix E***  
***8-Bit Binary-Coded-Decimal Table***

Table E-1. 8-Bit Binary-Coded-Decimal

Binary									Binary									Binary									Binary								
7	6	5	4	3	2	1	0	Dec	7	6	5	4	3	2	1	0	Dec	7	6	5	4	3	2	1	0	Dec	7	6	5	4	3	2	1	0	Dec
0	0	0	0	0	0	0	0	000	0	1	0	0	0	0	0	0	064	1	0	0	0	0	0	0	0	0	0	0	0	192					
0	0	0	0	0	0	0	1	001	0	1	0	0	0	0	0	1	065	1	0	0	0	0	0	0	1	1	1	0	0	1	193				
0	0	0	0	0	0	1	0	002	0	1	0	0	0	0	1	0	066	1	0	0	0	0	0	1	0	1	0	0	1	0	194				
0	0	0	0	0	0	1	1	003	0	1	0	0	0	0	1	1	067	1	0	0	0	0	0	1	1	1	0	0	1	1	195				
0	0	0	0	0	1	0	0	004	0	1	0	0	0	1	0	0	068	1	0	0	0	0	1	0	0	1	0	0	0	0	196				
0	0	0	0	0	1	0	1	005	0	1	0	0	0	1	0	1	069	1	0	0	0	0	1	0	1	1	0	0	1	0	197				
0	0	0	0	0	1	1	0	006	0	1	0	0	0	1	1	0	070	1	0	0	0	0	1	1	0	1	0	0	1	0	198				
0	0	0	0	0	1	1	1	007	0	1	0	0	0	1	1	1	071	1	0	0	0	0	1	1	1	1	0	0	1	1	199				
0	0	0	0	1	0	0	0	008	0	1	0	0	1	0	0	0	072	1	0	0	0	1	0	0	0	1	0	0	0	0	200				
0	0	0	0	1	0	0	1	009	0	1	0	0	1	0	0	1	073	1	0	0	0	1	0	0	1	1	0	0	0	1	201				
0	0	0	0	1	0	1	0	010	0	1	0	0	1	0	1	0	074	1	0	0	0	1	0	1	0	1	0	0	1	0	202				
0	0	0	0	1	0	1	1	011	0	1	0	0	1	0	1	1	075	1	0	0	0	1	0	1	1	1	0	0	1	1	203				
0	0	0	0	1	1	0	0	012	0	1	0	0	1	1	0	0	076	1	0	0	0	1	1	0	0	1	0	0	0	0	204				
0	0	0	0	1	1	0	1	013	0	1	0	0	1	1	0	1	077	1	0	0	0	1	1	0	1	1	0	0	1	0	205				
0	0	0	0	1	1	1	0	014	0	1	0	0	1	1	1	0	078	1	0	0	0	1	1	1	0	1	0	0	1	0	206				
0	0	0	0	1	1	1	1	015	0	1	0	0	1	1	1	1	079	1	0	0	0	1	1	1	1	1	0	0	1	1	207				
0	0	0	1	0	0	0	0	016	0	1	0	1	0	0	0	0	080	1	0	0	1	0	0	0	0	0	0	0	0	0	208				
0	0	0	1	0	0	0	1	017	0	1	0	1	0	0	0	1	081	1	0	0	1	0	0	0	1	1	0	0	0	1	209				
0	0	0	1	0	0	1	0	018	0	1	0	1	0	0	1	0	082	1	0	0	1	0	0	1	0	1	0	0	1	0	210				
0	0	0	1	0	0	1	1	019	0	1	0	1	0	0	1	1	083	1	0	0	1	0	0	1	1	1	0	0	1	1	211				
0	0	0	1	0	1	0	0	020	0	1	0	1	0	1	0	0	084	1	0	0	1	0	1	0	0	1	0	0	0	0	212				
0	0	0	1	0	1	0	1	021	0	1	0	1	0	1	0	1	085	1	0	0	1	0	1	0	1	1	0	0	1	0	213				
0	0	0	1	0	1	1	0	022	0	1	0	1	0	1	1	0	086	1	0	0	1	0	1	1	0	1	0	0	1	0	214				
0	0	0	1	0	1	1	1	023	0	1	0	1	0	1	1	1	087	1	0	0	1	0	1	1	1	1	0	0	1	1	215				
0	0	0	1	1	0	0	0	024	0	1	0	1	1	0	0	0	088	1	0	0	1	1	0	0	0	0	0	0	0	0	216				
0	0	0	1	1	0	0	1	025	0	1	0	1	1	0	0	1	089	1	0	0	1	1	0	0	1	1	0	0	0	1	217				
0	0	0	1	1	0	1	0	026	0	1	0	1	1	0	1	0	090	1	0	0	1	1	0	1	0	1	0	0	1	0	218				
0	0	0	1	1	0	1	1	027	0	1	0	1	1	0	1	1	091	1	0	0	1	1	0	1	1	1	0	0	1	1	219				
0	0	0	1	1	1	0	0	028	0	1	0	1	1	1	0	0	092	1	0	0	1	1	1	0	0	0	0	0	0	0	220				
0	0	0	1	1	1	0	1	029	0	1	0	1	1	1	0	1	093	1	0	0	1	1	1	0	1	1	0	0	1	0	221				
0	0	0	1	1	1	1	0	030	0	1	0	1	1	1	1	0	094	1	0	0	1	1	1	1	0	1	0	0	1	0	222				
0	0	0	1	1	1	1	1	031	0	1	0	1	1	1	1	1	095	1	0	0	1	1	1	1	1	1	0	0	1	1	223				
0	0	1	0	0	0	0	0	032	0	1	1	0	0	0	0	0	096	1	0	1	0	0	0	0	0	0	0	0	0	0	224				
0	0	1	0	0	0	0	1	033	0	1	1	0	0	0	0	1	097	1	0	1	0	0	0	0	1	1	0	0	0	0	225				
0	0	1	0	0	0	1	0	034	0	1	1	0	0	0	1	0	098	1	0	1	0	0	0	0	1	0	0	0	1	0	226				
0	0	1	0	0	0	1	1	035	0	1	1	0	0	0	1	1	099	1	0	1	0	0	0	0	1	1	0	0	0	1	227				
0	0	1	0	0	1	0	0	036	0	1	1	0	0	1	0	0	100	1	0	1	0	0	1	0	0	0	0	0	0	0	228				
0	0	1	0	0	1	0	1	037	0	1	1	0	0	1	0	1	101	1	0	1	0	0	1	0	1	1	0	0	0	0	229				
0	0	1	0	0	1	1	0	038	0	1	1	0	0	1	1	0	102	1	0	1	0	0	1	1	0	1	0	0	0	0	230				
0	0	1	0	0	1	1	1	039	0	1	1	0	0	1	1	1	103	1	0	1	0	0	1	1	1	1	0	0	0	0	231				
0	0	1	0	1	0	0	0	040	0	1	1	0	1	0	0	0	104	1	0	1	0	1	0	0	0	0	0	0	0	0	232				
0	0	1	0	1	0	0	1	041	0	1	1	0	1	0	0	1	105	1	0	1	0	1	0	0	1	1	0	0	0	0	233				
0	0	1	0	1	0	1	0	042	0	1	1	0	1	0	1	0	106	1	0	1	0	1	0	1	0	1	0	0	0	0	234				
0	0	1	0	1	0	1	1	043	0	1	1	0	1	0	1	1	107	1	0	1	0	1	0	1	1	1	0	0	0	0	235				
0	0	1	0	1	1	0	0	044	0	1	1	0	1	1	0	0	108	1	0	1	0	1	1	0	0	0	0	0	0	0	236				
0	0	1	0	1	1	0	1	045	0	1	1	0	1	1	0	1	109	1	0	1	0	1	1	0	1	1	0	0	0	0	237				
0	0	1	0	1	1	1	0	046	0	1	1	0	1	1	1	0	110	1	0	1	0	1	1	1	0	1	0	0	0	0	238				
0	0	1	0	1	1	1	1	047	0	1	1	0	1	1	1	1	111	1	0	1	0	1	1	1	1	1	0	0	0	0	239				
0	0	1	1	0	0	0	0	048	0	1	1	1	0	0	0	0	112	1	0	1	1	0	0	0	0	0	0	0	0	0	240				
0	0	1	1	0	0	0	1	049	0	1	1	1	0	0	0	1	113	1	0	1	1	0	0	0	1	1	0	0	0	0	241				
0	0	1	1	0	0	1	0	050	0	1	1	1	0	0	1	0	114	1	0	1	1	0	0	1	0	1	0	0	0	0	242				
0	0	1	1	0	0	1	1	051	0	1	1	1	0	0	1	1	115	1	0	1	1	0	0	1	1	1	0	0	0	0	243				
0	0	1	1	0	1	0	0	052	0	1	1	1	0	1	0	0	116	1	0	1	1	0	1	0	0	0	0	0	0	0	244				
0	0	1	1	0	1	0	1	053	0	1	1	1	0	1	0	1	117	1	0	1	1	0	1	0	1	1	0	0	0	0	245				
0	0	1	1	0	1	1	0	054	0	1	1	1	0	1	1	0	118	1	0	1	1	0	1	1	0	1	0	0	0	0	246				
0	0	1	1	0	1	1	1	055	0	1	1	1	0	1	1	1	119	1	0	1	1	0	1	1	1	1	0	0	0	0	247				
0	0	1	1	1	0	0	0	056	0	1	1	1	1	0	0	0	120	1	0	1	1	1	0	0	0	0	0	0	0	0	248				
0	0	1	1	1	0	0	1	057	0	1	1	1	1	0	0	1	121	1	0	1	1	1	0	0	1	1	0	0	0	0	249				
0	0	1	1	1	0	1	0	058	0	1	1	1	1	0	1	0	122	1	0	1	1	1	0	1	0	1	0	0	0	0	250				

# ***Appendix F***

## ***Memory Card File Formats***

### ***Introduction***

This appendix contains a description of the format of the binary files created by the 2635A Data Bucket. This information is intended to describe the contents in enough detail to allow someone well versed in a software programming language to use this information to write software to read and interpret the Data Bucket scan data files. (This example ;uses the ANSI C Language to examples of decoding and interpreting the file data. This code can be compiled using the Microsoft C Compiler on an MS-DOS PC or compatible.)

### ***Data File Format***

The data file format consists of two parts: a header, including the Data Bucket configuration during the time the data was gathered: followed by any scan data collected.

### ***Setup File Format***

The setup file format is very similar to the data file format. The only differences are the byte at offset zero has a value of 0 instead of 1, and there is never any scan data (the file always ends at offset 729).

The details of the Hydra Data Bucket binary file configuration format are as follows. A good familiarity with the operation of the Hydra Data Bucket will be necessary to understand much of the configuration information. For the most part, however, it is not necessary to understand all of the configuration information to be able to successfully manipulate the scan data. The references are to compute interface commands in Chapter 4.

Offset	Description
====	=====
0	File type; 0 for setup files, 1 for data files.
1	File format; always zero for this format.
2-81	Tag string. Copied from the setup file used with a time string appended; or just a time string if no setup file used.
82	Set up format version; always zero.
83	Global instrument configuration; 0x01 bit set for degrees Fahrenheit, else Centigrade; 0x02 bit set for open thermocouple checking enabled; 0x80 bit set for alarms on open thermocouple. See TEMP_CONFIG.
84	Measurement rate; 0 for slow, 1 for fast. See RATE.
85	Trigger type; 0 for off, 1 for on, 2 for monitor alarm. See TRIGGER.
86	Output format type; 1 for no units, 2 for units. See FORMAT.
87	Totalizer debounce; 0 for off, 1 for on. See TOTAL_DBNC.
88	Interval BCD hours. See INTERVAL.
89	Interval BCD minutes.
90	Interval BCD seconds.
91	Event Status Register (ESR) value.
92	Service Request Enable (ESE) register value.
93	Instrument Event Enable (IEE) register value.
94	Logging status; 0x1 bit set if logging enabled, 0x02 bit set if LOG queue stops logging when full. See LOG_MODE.
95	Logging filter; 0 for all, 1 for alarms, 2 for alarm transitions. See PRINT_TYPE.
96	Logging destination; 0x01 bit for printer, 0x02 bit set for LOG queue, 0x04 bit set for memory card. See PRINT_TYPE.
97	Front panel lock mode; 0 for not locked, 3 for configuration lock. See LOCK.
98-727	Channel definitions:
	Offset within each channel definition
	Description
0	Measurement. 0 if off, 1 if vdc, 2 if vac, 3 if ohms, 4 if frequency, 9 if thermocouple, 11 if RTD.
1	Measurement range. Lower bit values are measurement range, with 0 being the lowest range for the measurement type (e.g., 0 for 300 mVDC). 0x10 bit set if autoranging. See RANGE?
2	Thermocouple/RTD type. 0 for Pt, 1 for J, 2 for K, 3 for E, 4 for T, 5 for N, 6 for R, 7 for S, 8 for B, 9 for C.
3	Alarm flags. 0x01 bit set for limit 1 (SP1) low, 0x02 bit set for SP1 high, 0x04 bit set for limit 2 (SP2) low, 0x08 bit set for SP2 high. See ALARM_LIMIT.
4-7	Alarm limit 1 (4-byte single-precision floating point).
8-11	Alarm limit 2 (4-byte single-precision floating point).
12	Alarm 1 digital I/O association. See ALARM_ASSOC.
13	Alarm 1 display range. See SCALE_MB (DISPLAY CODE - 1).
14	Alarm 2 digital I/O association. See ALARM_ASSOC.
15	Alarm 2 display range. See SCALE_MB (DISPLAY CODE - 1).
16-19	Mx+B M value (floating point).
20-23	Mx+B B value (floating point).
24	Mx+B M display range. See SCALE_MB (DISPLAY CODE - 1).
25	Mx+B B display range. See SCALE_MB (DISPLAY CODE - 1).
26-29	RTD R0 value (floating point). See RTD_R0.

728-729 CRC-16 of the data from offset 82 to 727.

For a data file, any scan data would immediately follow the configuration information. Note that it is very possible to have no scan data if the data file is created but scanning is never done.

Measurements are stored in scan records of variable size. The contents of each record is as follows:

Offset	Description
====	=====
0	Time BCD hours. See TIME_DATE?
1	Time BCD minutes.
2	Time BCD seconds.
3	Date BCD month.
4	Date BCD day.
5	Date BCD year.
6	Alarm output values. See ALARM_DO_LEVELS?
7	Digital Input/Output values. See DIO_LEVELS?
8-11	Totalizer value, 4-byte single precision floating point.
12-on	Measurement values, from 1 to 21 4-byte single precision floating-point numbers.

The number of floating point values per scan is the number of non-off channels in the channel configuration data. The number of scans per file varies from zero to tens of thousands, but will always be an integral number (there will be no partial scans).

### **Example**

The following is an example of how the configuration and scan data can be interpreted using the C programming language. The C code shown here can be incorporated into a C program and used to access the information contained in Hydra Data Bucket data files. These examples can not, however be compiled and used as they are. They are not meant to be complete C programs.

This first part of the example creates a structure named 'hydra' that will hold the configuration information read from the data file.

```
/* Hydra Data Bucket data file format: */
struct hydra_config {
    unsigned char file_type;
    unsigned char file_format;
    unsigned char tag[80];
    unsigned char setup_format;
    unsigned char system;
    unsigned char rate;
    unsigned char trigger;
    unsigned char format;
    unsigned char total_debounce;
    unsigned char interval_bcd_hours;
    unsigned char interval_bcd_minutes;
    unsigned char interval_bcd_seconds;
    unsigned char ese;
    unsigned char sre;
    unsigned char iee;
    unsigned char log_status;
    unsigned char log_filter;
    unsigned char log_dest;
    unsigned char lock;
    struct hydra_chan {
        unsigned char function;
        unsigned char range;
        unsigned char temperature;
        unsigned char alarm_flags;
        float alarm_limit_1;
        float alarm_limit_2;
        unsigned char alarm_assoc_1;
        unsigned char alarm_dr_1;
        unsigned char alarm_assoc_2;
        unsigned char alarm_dr_2;
        float m;
        float b;
        unsigned char m_dr;
        unsigned char b_dr;
        float rtd_r0;
    } chan[21];
} hydra;

/*
** A count of the number of channel measurements in each scan record will
** be needed. Also, a table to determine the proper channel number for
** each measurement will be created while getting the channel configuration
** information.
*/

int max_index;
int index_to_chan[21];
```



The following function will copy the configuration information from the data file into the 'hydra' structure, keeping track of the number of configured channels and filling the channel index table as it goes. It assumes that the first 730 bytes of the file have already been read into memory using the read () library function, or similar.

```

/*
-* convert_config(): Convert the file configuration data into C variables.
**
** Inputs:
**     file_data      Pointer to the first 730 bytes of data
**                   from a Hydra Data Bucket file.
** Outputs:
**     hydra          Global variable set to the configuration
**                   found in the file data.
**     max_index      number of channels in scan record and
**     index_to_chan  the table of non-off channels
**
** Returns:
**     number of bytes per scan record.
*/

int
convert_config(unsigned char * file_data)
{
    int ch;

    /* Must be a data file (file_type must = 1) */
    hydra.file_type = *file_data++;

    /* Must be version 0 format */
    hydra.file_format = *file_data++;

    /* Copy tag */
    memcpy(hydra.tag, file_data, 80);
    file_data += 80;

    /* Must be configuration format zero */
    hydra.setup_format = *file_data++;

    /* Convert global configuration */
    hydra.system = *file_data++;
    hydra.rate = *file_data++;
    hydra.trigger = *file_data++;
    hydra.format = *file_data++;
    hydra.total_debounce = *file_data++;

    hydra.interval_bcd_hours = *file_data++;
    hydra.interval_bcd_minutes = *file_data++;
    hydra.interval_bcd_seconds = *file_data++;

    hydra.esr = *file_data++;
    hydra.sre = *file_data++;
    hydra.ise = *file_data++;

    hydra.log_status = *file_data++;
    hydra.log_filter = *file_data++;
    hydra.log_dest = *file_data++;

    hydra.lock = *file_data++;

    /* Convert channel configurations */
    /* Count number of non-off channels during conversion */
    max_index = 0;

    for (ch=0; ch < 21; ch++) {

```

```

        hydra.chan[ch].function = *file_data++;
        hydra.chan[ch].range = *file_data++;
        hydra.chan[ch].temperature = *file_data++;
        hydra.chan[ch].alarm_flags = *file_data++;
        file_data += convert_float(&hydra.chan[ch].alarm_limit_1,
                                   file_data);
        file_data += convert_float(&hydra.chan[ch].alarm_limit_2,
                                   file_data);
        hydra.chan[ch].alarm_assoc_1 = *file_data++;
        hydra.chan[ch].alarm_dr_1 = *file_data++;
        hydra.chan[ch].alarm_assoc_2 = *file_data++;
        hydra.chan[ch].alarm_dr_2 = *file_data++;
        file_data += convert_float(&hydra.chan[ch].m, file_data);
        file_data += convert_float(&hydra.chan[ch].b, file_data);
        hydra.chan[ch].m_dr = *file_data++;
        hydra.chan[ch].b_dr = *file_data++;
        file_data += convert_float(&hydra.chan[ch].rtd_r0, file_data);

        /* Create index to channel conversion table */
        if (hydra.chan[ch].function != 0) {
            index_to_chan[max_index++] = ch;
        }
    }
    /* Ignore trailing CRC bytes */

    /* return number of bytes per scan record */
    return (4 * max_index + 12);
}

/*
** convert_float(): Convert binary data stream to a floating point variable
**
** This routine assumes that both input and output are four-byte IEEE
** single-precision data in the DOS (Intel x86) architecture. This
** is very machine dependent. You may need to change this routine to
** fit the needs of your architecture.
**
** Inputs:
**     float_dest      Pointer to C floating point variable (destination).
**     src             Pointer to four bytes of binary file data.
**
** Outputs:
**     float_dest      Set to a floating point value.
**
** Returns:
**     Number of bytes consumed (4)
**
*/

int
convert_float(float * dest, unsigned char * src)
{
    unsigned char * byte_dest = (unsigned char *) dest;

    *byte_dest++ = *src++;
    *byte_dest++ = *src++;
    *byte_dest++ = *src++;
    *byte_dest  = *src;

    return sizeof(float);
}

```

Now that the configuration has been processed and the number of valid channels has been determined, the scan data can be processed.

```

/* Measurements are stored in scan records of variable size.
** This C structure is the decoded version of a scan record,
** and is of fixed size (unused measurement values are not set).
*/
struct scan_record {

    /* Timestamp */
    unsigned char bcd_hours;
    unsigned char bcd_minutes;
    unsigned char bcd_seconds;
    unsigned char bcd_month;
    unsigned char bcd_day;
    unsigned char bcd_year;

    /* Digital (alarm) outputs */
    unsigned char dout;

    /* Digital input/outputs */
    unsigned char dio;

    /* Totalizer value */
    float total;

    /* Measurement per channel */
    float meas[21];
} scan;

/*
-* convert_scan_record(): Convert a scan record into usable data
**
** In each data file, after the 730 bytes of configuration data, an
** array of scan records may be found (it is possible for data files
** to have no scan data). This routine converts a single scan record
** and places it in the given destination buffer.
**
** Note that convert_config() must be called before this routine!
**
** Inputs:
**   hydra           File configuration data.
**   max_index      number of channels in scan record and
**   index_to_chan  the table of non-off channels
**   file_data      A single scan record from the same data file.
**                  that was last processed by convert_config().
**                  Note that this routine assumes that the
**                  number of bytes in this buffer is exactly the
**                  number of bytes per scan record.
**   scan           Pointer to destination scan record buffer.
**
** Outputs:
**   scan           Set to converted version of scan record.
*/

void
convert_scan_record(unsigned char * file_data, struct scan_record * scan)
{
    int index;
    int ch;

```

```
/* Set timestamp */
scan->bcd_hours = *file_data++;
scan->bcd_minutes = *file_data++;
scan->bcd_seconds = *file_data++;
scan->bcd_month = *file_data++;
scan->bcd_day = *file_data++;
scan->bcd_year = *file_data++;

/* Get digital I/O and totalizer values */
scan->dout = *file_data++;
scan->dio = *file_data++;
file_data += convert_float(&scan->total, file_data);

/* Get measurement for each non-off channel in this scan */
for (index=0; index < max_index; index++) {

    /* Convert index to channel */
    ch = index_to_chan[index];

    /* Read this channel's scan data */
    file_data += convert_float(&scan->meas[ch], file_data);
}
}
```

Using the above routines to decode the configuration of a data file and get the contents of the first scan record will require something like the following:

```
char * file = "DAT00.HYD";
int fd;
unsigned char buf[730];
int record_size;

/* Open the binary data file name pointed to by "file" */
fd = open(file, (O_RDONLY | O_BINARY));

/* Read and interpret the configuration header in the file */
read(fd, buf, 730);
record_size = convert_config(buf);

/* Read and convert the scan measurements */
read(fd, buf, record_size);
convert_scan_record(buf, &scan);
```

# Appendix G

## True RMS Measurements

### **Introduction**

The instrument measures the true value of ac voltages. In physical terms, the rms (root-means-square) value of a waveform is the equivalent dc value that causes the same amount of heat to be dissipated in a resistor. True rms measurement greatly simplifies the analysis of complex ac signals. Since the rms value is the dc equivalent of the original waveform, it provides a reliable basis for comparing dissimilar waveforms.

### **Effect of Internal Noise in AC Measurements**

With the input shorted and the channel set for ac volts (VAC) measurement, internal amplifier noise causes a typical display reading of approximately 0.50 mv ac. Since the instrument is a true rms responding measurement device, this noise contributes minimally to the readings at the specified floor of each range. When the rms value of the two signals (internal noise and range floor) is calculated, the effect of the noise is shown as:

Total rms digits = Square Root of  $(0.50^2 + 15.00^2) = 15.008$

The display will read 15.01. At the 28.00 mV input level on the 300.00 mV range in the slow rate, the display will read 28.00 with no observable error.

### **Waveform Comparison (True RMS VS Average Responding)**

Figure H-1 illustrates the relationship between ac and dc components for common waveforms and compares readings for true rms measurements (Hydra) and average-responding measurements. For example, consider the first waveform, a 1.41421V (zero-to-peak) sine wave. Both the instrument and rms-calibrated average-responding measurement devices display the correct rms reading of 1.0000V ac (the dc component equals ). However, consider the 2V (peak-to peak) square wave.

Both types of measurement correctly display the dc component (0V), but the instrument also correctly measures the ac component (1.0000V). The average-responding device measures 1.11V, which amounts to an 11% error.

Average-responding measurement devices have been in use for a long time; you may have accumulated test or reference data based on such instruments. The conversion factors in Figure G-1 can help in converting between the two measurement methods.

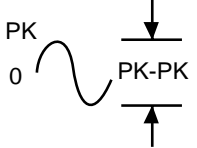
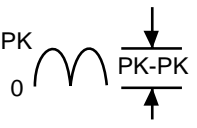
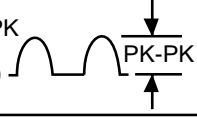
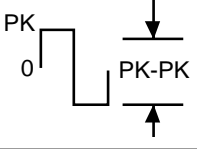
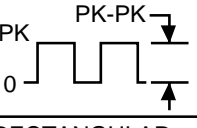
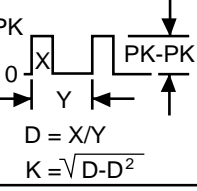
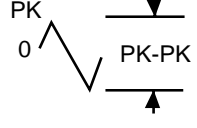
AC-COUPLED INPUT WAVEFORM	PEAK VOLTAGES		MEASURED VOLTAGES			DC AND AC TOTAL RMS
	PK-PK	0-PK	AC COMPONENT ONLY		DC COMPONENT ONLY	
			RMS CAL*	HYDRA		TRUE RMS = $\sqrt{ac^2 + dc^2}$
SINE 	2.828	1.414	1.000	1.000	0.000	1.000
RECTIFIED SINE (FULL WAVE) 	1.414	1.414	0.421	0.436	0.900	1.000
RECTIFIED SINE (HALF WAVE) 	2.000	2.000	0.779	0.771	0.636	1.000
SQUARE 	2.000	1.000	1.111	1.000	0.000	1.000
RECTIFIED SQUARE 	1.414	1.414	0.785	0.707	0.707	1.000
RECTANGULAR PULSE  <p> <math>D = X/Y</math>  <math>K = \sqrt{D-D^2}</math> </p>	2.000	2.000	4.442 K <sup>2</sup>	2K	2D	$2\sqrt{D}$
TRIANGLE SAWTOOTH 	3.464	1.732	0.962	1.000	0.000	1.000
* RMS CAL IS THE DISPLAYED VALUE FOR AVERAGE RESPONDING INSTRUMENTS THAT ARE CALIBRATED TO DISPLAY RMS FOR SINE WAVES						

078f.eps

Figure G-1. Comparison of Common Waveforms

## Hydra Configuration Record

SET-UP NAME _____		DATE _____	
SCAN RATE:	<input type="checkbox"/> Slow <input type="checkbox"/> Fast	TEMPERATURE UNITS	<input type="checkbox"/> °C <input type="checkbox"/> °F
		RS-232-C COMMUNICATION	
SCAN INTERVAL:	_____:_____:_____	Baud Rate	<input type="checkbox"/> 38400 <input type="checkbox"/> 19200 <input type="checkbox"/> 9600 <input type="checkbox"/> 4800 <input type="checkbox"/> 2400 <input type="checkbox"/> 1200 <input type="checkbox"/> 600 <input type="checkbox"/> 300
OUTPUT:	<input type="checkbox"/> Printer <input type="checkbox"/> Memory Mode: <input type="checkbox"/> All Data <input type="checkbox"/> Alarm Data <input type="checkbox"/> Alarm Transition Data	Parity	<input type="checkbox"/> Even <input type="checkbox"/> Odd <input type="checkbox"/> None CTS <input type="checkbox"/> On <input type="checkbox"/> Off Echo <input type="checkbox"/> On <input type="checkbox"/> Off
TRIGGERS:	<input type="checkbox"/> Off <input type="checkbox"/> External <input type="checkbox"/> Monitor Alarm Ch# _____	Totalizer Debounce <input type="checkbox"/> On <input type="checkbox"/> Off	

Chan	Input Name	Type	Range	LIM 1	Alarm Output	LIM 2	Alarm Output	M	B
0					0		0		
1					1		1		
2					2		2		
3					3		3		
4					4		4		
5					5		5		
6					6		6		
7					7		7		
8					8		8		
9					9		9		
10					10		10		
11					11		11		
12					12		12		
13					13		13		
14					14		14		
15					15		15		
16					16		16		
17					17		17		
18					18		18		
19					19		19		
20					20		20		





# Index

## —2—

2-wire accuracy, A-8, A-12

## —A—

AC operation, 1-13  
Ac signal cross talk in a dc voltage channel, B-1  
Ac signal cross talk into a frequency channel, B-3  
Ac signal cross talk into an ac voltage channel, B-2  
Ac signal cross talk into an ohms channel, B-2  
Ac signal crosstalk into a temperature channel, B-3  
AC Voltage Measurements, A-8  
accuracy verification test, 7-7  
adjusting the handle, 1-12  
Alarm indications while monitoring, 2-19  
Alarm indications while reviewing, 2-19  
Alarm indications while scanning, 2-18  
Alarm outputs, 1-17  
alarm outputs and digital I/O, 1-9  
alarm outputs connections, 1-17  
Alarm outputs for channel 0 to 3 using the alarm outputs connector, 2-19  
Alarm outputs for channels 4 to 20 using the digital I/O connector, 2-19  
alarms, 1-9  
Alarms and autotyping, 2-20  
Alarms and monitor-alarm triggering, 2-20  
Alarms and Mx+B scaling, 2-20  
applications software, 1-9

## —C—

calibration, 7-21  
changing the memory card during scanning, 3-5

channel integrity test, 7-8  
cleaning, 7-3  
Clearing alarm parameters from a channel, 2-19  
Clearing Mx+B scaling from a channel, 2-23  
Common mode rejection, A-10  
computer interface command set, 4-18  
computer interface commands and operation, 4-12  
computer operation, 1-8  
configuring a channel to measure ac volts, 2-10  
configuring a channel to measure dc volts, 2-9  
configuring a channel to measure frequency, 2-12  
configuring a channel to measure resistance, 2-11  
configuring a measurement channel, 2-8  
configuring for printer operations, 5-5  
configuring the instrument for computer operations, 4-5  
configuring the instrument for modem operations, 6-7  
configuring the instrument for operation, 2-6  
configuring the instrument modem for modem operations, 6-4  
configuring the pc for computer operations, 4-6  
connecting the instrument to a pc, 4-3  
connecting the instrument to a power source, 1-12  
connecting the instrument to a printer, 5-3  
connecting the modem to a pc for modem configuration, 6-4  
connecting the modem to an instrument, 6-6  
connector set, 2620a-100, 1-10  
controls and indicators, 1-19  
crosstalk, 1-14  
Cross-talk rejection, A-8

## —D—

data file procedures, 3-12

DC operation, 1-13  
DC power, 1-17  
Decoding the ascii string, C-1  
dedicated alarm output test, 7-18  
Digital I/O, 1-18  
digital I/O connections, 1-18  
Digital input test, 7-16  
Digital output test, 7-15

## —E—

Example, C-7  
Examples, 2-23  
External trigger, 2-31  
External trigger input, 1-17  
external trigger input test, 7-21

## —F—

Floating point conversion, C-4  
four-terminal resistance test, 7-10  
front panel controls, 1-19  
front panel indicators, 1-19  
front panel operation, 1-7

## —H—

how the instrument processes input, 4-12  
how the instrument processes output, 4-13  
hydra logger package, 1-10  
hydra starter package, 1-10  
Hysteresis, A-14

## —I—

initializing a memory card, 3-7  
input channels, 1-13  
Input debouncing, A-14  
input string examples, 4-13  
input terminators, 4-12  
Input voltage, A-14  
inserting a memory card, 3-5  
inserting and removing the memory card, 3-5  
installing or replacing the memory card  
  battery, 3-5  
Instrument event register (IER), 4-14  
Isolation, A-14

## —L—

line fuse, 7-3

## —M—

Maximum autoranging time, A-14  
measurement capabilities, 1-9  
Memory card as a data destination, 2-26  
memory card battery, 3-5

memory card capacity, 3-4  
Memory card capacity, 2-26  
Memory card data extraction, 2-27  
Memory card exchange during scanning, 2-26  
memory card file operations to and  
  from a pc, 3-16  
Memory card files, 2-26  
Memory card formatting, 2-26  
memory card operation, 1-7  
memory card reader, 1-10  
modem operation, 1-8  
Monitor-alarm trigger, 2-31  
Mx+B scaling, 1-9

## —O—

open thermocouple response test, 7-11  
operating modes, 1-5, 2-26  
options and accessories, 1-10

## —P—

performance tests, 7-4  
printer operation, 1-8  
printing measurement data and memory card  
  directory, 5-6  
printing measurement results during  
  scanning, 5-6  
printing the directory of the memory card, 5-9  
printing the review array, 5-8

## —R—

Rate, A-14  
recording measurement results during  
  scanning, 3-8  
removing a memory card, 3-5  
Resistance temperature detectors  
  restrictions:, 2-13  
Resistance-temperature detectors, 2-13  
Restrictions, 2-8, 2-9, 2-10, 2-11, 2-12, 2-23  
RTD temperature accuracy test, 7-13  
RTD temperature accuracy test (using decade  
  resistance source), 7-13  
RTD temperature accuracy test (using DIN/IEC  
  751 RTD), 7-14

## —S—

selecting a channel, 2-8  
selftest diagnostics and error codes, 7-4  
sending numeric values to the instrument, 4-13  
Sensitivity, A-12  
service, 7-22  
setting the memory card write-protect  
  feature, 3-5  
setting the Mx+B scaling, 2-23

setting up the instrument, 1-11  
setup and data file current status, 3-15  
setup and data files directory, 3-14  
setup file procedures, 3-9  
Standard event status register (ESR), 4-16  
Status byte register (STB), 4-17  
status registers, 4-14  
summary of computer operations, 4-3  
summary of front panel operations, 2-5  
summary of memory card operations, 3-3  
summary of modem operations, 6-3  
summary of printer operations, 5-3

### —T—

testing the instrument/pc RS-232 interface, 4-6  
testing the RS-232 interface using gwbasic, 4-9  
testing the RS-232 interface using Qbasic, 4-10  
testing the RS-232 interface using terminal  
emulation (generic), 4-7  
testing the RS-232 interface using terminal  
emulation (windows), 4-6  
testing the RS-232/modem interface, 6-8  
thermocouple measurement range accuracy  
test, 7-9  
Thermocouple restrictions:, 2-13  
thermocouple temperature accuracy test, 7-10  
Thermocouples, 2-13  
Threshold, A-14

totalizer channel, 1-9  
Totalizer input, 1-18  
Totalizer sensitivity test, 7-18  
Totalizer test, 7-17  
Totalizing input, A-14  
Triggering options and memory card  
operation, 2-31  
turning the power on, 2-6

### —U—

universal input module connections, 1-14  
unpacking and inspecting the instrument, 1-11  
using data erase, 3-13  
using data open, 3-12  
using setup erase, 3-11  
using setup load, 3-10  
using setup store, 3-9  
using shielded wiring, 1-14  
using the scan mode, 2-26

### —V—

variations in the display, 7-22

### —X—

xmodem file transfers, 4-18

